



**US Army Corps
of Engineers®**
New York District

Storm Surge Barriers Sub-Appendix

DRAFT

New York – New Jersey Harbor and Tributaries Coastal Storm Risk Management Feasibility Study

Sub-Appendix B2

September 2022

Table of Contents

1	Introduction.....	20
1.1	Project Overview.....	20
1.1.1	The Study.....	20
1.1.2	Organization of Engineering Analyses.....	20
1.2	Storm Surge Barrier Sub-Appendix Content.....	21
1.2.1	Scope.....	21
1.2.2	Perimeter Flood Risk Reduction vs. Coastal Barriers.....	21
1.2.3	Navigable Storm Surge Barriers in the NYNJHAT Study Alternatives.....	23
1.3	Organization.....	27
1.3.1	Reader’s Guide.....	27
1.3.2	Limitations.....	30
1.4	Prior Studies and Reports.....	30
2	Basis of Design.....	34
2.1	Introduction.....	34
2.2	Available Data.....	35
2.3	Design References.....	35
2.3.1	Codes and Standards.....	35
2.3.2	Prior Reports and Studies.....	36
2.4	System of Units and Reference Datum.....	37
2.5	Service Life.....	37
2.6	Functional Requirements.....	37
2.6.1	Basic Requirements.....	37
2.6.2	Operations and Maintenance.....	38
2.6.3	Constructability & Existing Subaqueous Utilities.....	40
2.7	Hydraulic/Coastal BOD.....	42
2.7.1	Bathymetry and Topography.....	42
2.7.2	Navigation.....	42
2.7.3	Hydrological Characteristics.....	45
2.7.4	Design Water Densities.....	47
2.7.5	Astronomical Tides.....	47
2.7.6	Relative Sea Level Change.....	49
2.7.7	Tidal Flows and Current Magnitudes.....	50
2.7.8	Extreme Water Levels.....	51

2.7.9	Extreme Wave Heights and Period.....	52
2.7.10	Wave Overtopping Criteria.....	53
2.7.11	Design Crest Elevation	53
2.7.12	Elevations for Lift Gates in Open Position.....	54
2.7.13	Direct and Reverse Head Conditions.....	56
2.8	Wind.....	56
2.9	Geotechnical.....	60
2.9.1	Settlement & Regional Subsidence.....	60
2.9.2	Design Subsurface Profiles.....	61
2.10	Materials.....	64
2.10.1	Reinforced Concrete	64
2.10.2	Hydraulic Structural Steel Structures.....	66
2.10.3	Cathodic Protection.....	67
2.10.4	Dissimilar Metals.....	68
2.11	Loads for Storm Surge Barriers	68
2.11.1	Gravity Loads.....	68
2.11.2	Hydrostatic Loads	69
2.11.3	Wind Loads.....	69
2.11.4	Wave Loads	69
2.11.5	Current Loads.....	69
2.11.6	Seismic Loads	69
2.11.7	Impact Loads.....	70
2.11.8	Structure Classification and Global Stability.....	71
3	Verrazzano Narrows Storm Surge Barrier.....	74
3.1	Location.....	74
3.2	Dimensions of the Navigable Passages.....	74
3.2.1	Navigable Passage Dimensions Verrazzano Narrows	75
3.3	Navigable Gate Type Selection.....	76
3.4	Auxiliary Flow Gates	76
3.5	General Project Phasing, Sequence of Construction, and Constructability Considerations	78
3.5.1	Project Phasing.....	79
3.5.2	Construction Sequence.....	79
3.5.3	Constructability.....	84
3.6	Navigation Accommodation	85

3.7	Preparatory Work	88
3.8	Islands.....	89
3.8.1	Stone Columns	89
3.8.2	Wick Drains	90
3.8.3	Island Fill	90
3.8.4	Surcharge and Settlement	90
3.9	Cofferdams and Other Temporary Construction Measures	90
3.10	Retaining Structures	91
3.10.1	Cellular Structures (Permanent and Temporary)	91
3.10.2	Retaining Walls.....	94
3.10.3	Wall Anchorage	94
3.10.4	Corrosion Protection Systems.....	95
3.11	Deep Foundations.....	96
3.11.1	Drilled Shafts	96
3.12	Floating Sector Gate.....	97
3.13	Gate Anchorage and Foundations	98
3.13.1	Dry Dock.....	98
3.13.2	Gate Sill	99
3.14	Secondary Sector Gate	100
3.14.1	Foundations.....	100
3.14.2	Abutments and Gate Pockets	100
3.14.3	Sector Gate.....	101
3.14.4	Sector Gate Materials.....	102
3.14.5	Access Bridge	103
3.14.6	Other Secondary Sector Gate Features	103
3.15	Scour Protection	104
3.15.1	Bed Protection for Floating Sector Gate.....	104
3.15.2	Lift Gate	105
3.16	Lift Gate	105
3.17	Dam Sections and Tie-ins	106
3.18	Siting Considerations	107
3.19	Synopsis	107
4	Jamaica Bay Storm Surge Barrier.....	108
4.1	Location of Jamaica Bay SSB.....	108

4.2	Dimensions of the Navigable Passages	109
4.2.1	Navigable Passage Dimensions – Jamaica Bay	109
4.3	Navigable Gate Type Selection.....	109
4.4	Auxiliary Flow Gates	110
4.5	General Phasing, Sequence, and Constructability.....	110
4.6	Navigation Accommodation	112
4.7	Preparatory Needs	113
4.8	Sector Gates.....	114
4.8.1	Foundations.....	114
4.8.2	Abutments and Gate Pockets	114
4.8.3	Sector Gate.....	115
4.8.4	Sector Gate Materials.....	116
4.8.5	Access Bridge	116
4.8.6	Other Secondary Sector Gate Features	116
4.9	Lift Gate	116
4.10	Scour Protection	118
4.10.1	Lift Gates	118
4.11	Dam Sections and Tie-ins	118
5	Hackensack Storm Surge Barrier.....	119
5.1	Location.....	119
5.1.1	Hackensack River	119
5.2	General Phasing, Sequence, and Constructability.....	120
5.3	Navigation Accommodation	121
5.4	Sector Gates.....	122
5.4.1	Foundations.....	122
5.4.2	Abutments and Gate Pockets	122
5.4.3	Sector Gates	122
5.5	Lift Gate	123
5.6	Scour Protection.....	124
5.6.1	Lift Gates	124
5.7	Dam Sections and Tie-ins	124
6	Geometric Characteristics of All Storm Surge Barriers	125
6.1	Introduction	125
6.2	Methodology to Establish General Geometric Characteristics	125

6.3	Outer Harbor	126
6.4	Throgs Neck.....	135
6.5	Verrazzano Narrows.....	139
6.6	Arthur Kill.....	139
6.6.1	Arthur Kill Conceptual Design.....	139
6.6.2	Siting Considerations.....	143
6.7	Jamaica Bay.....	144
6.8	Kill Van Kull.....	144
6.8.1	Kill Van Kull Conceptual Design.....	144
6.8.2	Additional Siting Considerations.....	148
6.9	Hackensack River.....	149
6.10	Newtown Creek.....	149
6.11	Gowanus Canal	153
6.12	Flushing Creek	157
6.13	Sheepshead Bay.....	161
6.14	Gerritsen Creek	165
6.15	Eastchester Creek.....	169
6.16	Port Washington.....	173
6.17	Hempstead Harbor (Glen Cove).....	177
6.18	Hammond Creek	181
6.19	Highlands	185
6.20	Raritan River	189
7	Navigable Barriers as Risk Reduction Features (RRFs).....	193
7.1	Introduction	193
7.2	Hackensack River RRF	194
7.3	Newtown Creek RRF	198
7.4	Gowanus Canal RRF	201
7.5	Sandy Hook Bridge RRF.....	204
7.6	Head of Bay Gate RRF.....	207
7.7	Old Howard Beach East Gate RRF	210
7.8	Old Howard Beach West Gate RRF.....	213
8	Recommendations for Further Study.....	216
8.1.1	Introduction.....	Error! Bookmark not defined.
8.1.2	Iterative Design – Next Steps	217

8.1.3	Constructability.....	220
8.1.4	Hydraulics, Hydrology, and the Aquatic Environment	220
8.1.5	Navigation.....	222
8.1.6	Operations and Maintenance.....	222
8.1.7	Multi-functionality of a Storm Surge Barrier Complex.....	223
	References.....	224
	Annexes.....	227

List of Tables

Table 1-1:	NYNJHAT CSRMS Feasibility Study Engineering Appendix and Sub-Appendices	21
Table 1-2:	Storm Surge Barriers (Primary Navigable Barriers) for NYNJHAT Study Alternatives	26
Table 1-3:	Summary of RRF Navigable Barriers (Secondary Navigable Barriers) per Alternative.....	27
Table 1-4:	Storm Surge Barriers and Navigable Gates and Reader’s Guide.....	29
Table 1-5:	Jamaica Bay Barrier Plans from USACE 1976 Study – Openings and Gate Dimensions (USACE-WES, 1976)	32
Table 1-6:	Preferred Storm Surge Barrier Plan from (USACE, 2016) – Openings and Gate Dimensions	32
Table 2-1:	List of Codes and Standards.....	36
Table 2-2:	Storm Surge Barriers Closure Criterion	39
Table 2-3:	Federal Navigation Channel Intersecting with the Proposed Storm Surge Barriers	43
Table 2-4:	Design Vessels for the Navigable Passages	45
Table 2-5:	Water Density for Design.....	47
Table 2-6:	Storm Surge Barrier Locations and Tidal Gauges.....	47
Table 2-7:	Tidal Datums for Station 8518750, The Battery, NY	47
Table 2-8:	Tidal Datums for Station 8531680, Sandy Hook, NJ.....	48
Table 2-9:	Tidal Datums for Station 8516945, Kings Point, NY	48
Table 2-10:	Tidal Datums for Station 8519483, Bergen Reach West, NY.....	49
Table 2-11:	Tidal Datums for Station 8530696, Amtrak RR Swing Bridge, Hackensack River, NJ.....	49
Table 2-12:	Relative Sea Level Change per USACE’s Intermediate Scenario in Feet (ft)	50
Table 2-13:	Tidal Fluxes	51
Table 2-14:	Tidal Currents.....	51
Table 2-15:	AEP Still Water Levels (50% confidence limit) from NACCS ADCIRC output, inclusive of Sea Level Rise in 2045 and 2095. Specific output nodes referenced in table.	52
Table 2-16:	AEP Wave Characteristics (50% Confidence Limit).....	53
Table 2-17:	Crest Elevations of Storm Surge Barriers	54

Table 2-18:	Elevations for Lift Gates in Open Position	55
Table 2-19:	ASCE 7-16 Design Wind Speed	56
Table 2-20:	Wind Gauges and Respective Applicability to SSB Locations.....	56
Table 2-21:	Estimated Settlement for the Verrazzano Narrows, Jamaica Bay, and Hackensack River Storm Surge Barriers.....	61
Table 2-22:	Verrazzano Narrows East Island Soil Profile (Unconsolidated)	61
Table 2-23:	Verrazzano Narrows East Island Soil Profile (Consolidated)	62
Table 2-24:	Verrazzano Narrows West Island Soil Profile (Unconsolidated).....	62
Table 2-25:	Verrazzano Narrows West Island Soil Profile (Consolidated).....	63
Table 2-26:	Jamaica Bay Soil Profile	63
Table 2-27:	Hackensack River Soil Profile	64
Table 2-28:	EM 1110-2-2100, Load Condition Probabilities.....	72
Table 3-1:	Minimum Practical Dimensions for the Navigable Passages of the Verrazzano Narrows SSB.....	76
Table 3-2:	Design Dimensions for the Auxiliary Flow Gates	78
Table 3-3:	Type of Traffic per SSB, According to AIS Information by Vessel Type.....	87
Table 3-4:	Verrazzano Narrows SSB Characteristics.....	87
Table 4-1:	Minimum Practical Dimensions for the Navigable Passages of the Jamaica Bay SSB	109
Table 4-2:	Design Dimensions for the Auxiliary Flow Gates	110
Table 4-3:	Jamaica Bay SSB Characteristics.....	113
Table 5-1:	Hackensack River SSB Characteristics.....	121
Table 6-1:	Summary of Storm Surge Barriers Per Alternatives	125
Table 6-2:	Summary of Environmental Design Criteria.....	127
Table 6-3:	Summary of the Outer Harbor Storm Surge Barrier Geometry – Navigable Passages and Auxiliary Flow Gates	133
Table 6-4:	Summary of Environmental Design Criteria.....	135
Table 6-5:	Summary of Throgs Neck Storm Surge Barrier Geometry – Navigable Passages and Auxiliary Flow Gates	138
Table 6-6:	Summary of Environmental Design Criteria.....	140
Table 6-7:	Summary of Storm Surge Barrier Geometry – Navigable Passages and Auxiliary Flow Gates	142
Table 6-8:	Summary of Environmental Design Criteria.....	145
Table 6-9:	Summary of Kill Van Kull Storm Surge Barrier Geometry – Navigable Passage and Auxiliary Flow Gates.....	147
Table 6-10:	Summary of Environmental Design Criteria (Newtown Creek)	150
Table 6-11:	Summary of Newtown Creek Storm Surge Barrier Geometry – Navigable Passage	152
Table 6-12:	Summary of Environmental Design Criteria (Gowanus Canal).....	153
Table 6-13:	Summary of Gowanus Canal Storm Surge Barrier Geometry – Navigable Passage	156
Table 6-14:	Summary of Environmental Design Criteria (Flushing Creek).....	158
Table 6-15:	Summary of Flushing Creek Storm Surge Barrier Geometry – Navigable Passages and Auxiliary Flow Gates	160
Table 6-16:	Summary of Environmental Design Criteria (Sheepshead Bay).....	161

Table 6-17:	Summary of Sheepshead Bay Storm Surge Barrier Geometry – Navigable Passage and Auxiliary Flow Gates.....	164
Table 6-18:	Summary of Environmental Design Criteria (Gerritsen Creek).....	165
Table 6-19:	Summary of Gerritsen Creek Storm Surge Barrier Geometry – Navigable Passage and Auxiliary Flow Gates.....	168
Table 6-20:	Summary of Environmental Design Criteria (East Chester Creek)	169
Table 6-21:	Summary of East Chester Creek Storm Surge Barrier Geometry – Navigable Passage and Auxiliary Flow Gates.....	172
Table 6-22:	Summary of Environmental Design Criteria (Port Washington)	173
Table 6-23:	Summary of Port Washington Storm Surge Barrier Geometry – Navigable Passage and Auxiliary Flow Gates.....	176
Table 6-24:	Summary of Environmental Design Criteria (Hempstead Harbor).....	177
Table 6-25:	Summary of Hempstead Harbor (Glen Cove) Storm Surge Barrier Geometry – Navigable Passage.....	180
Table 6-26:	Summary of Environmental Design Criteria (Hammond Creek).....	181
Table 6-27:	Summary of Hammond Creek Storm Surge Barrier Geometry – Navigable Passage and Auxiliary Flow Gates.....	184
Table 6-28:	Summary of Environmental Design Criteria (Highlands Storm Surge Barrier) ..	185
Table 6-29:	Summary of Highlands Storm Surge Barrier Geometry – Navigable Passage and Auxiliary Flow Gates.....	188
Table 6-30:	Summary of Environmental Design Criteria (Raritan River)	189
Table 6-31:	Summary of Raritan River Storm Surge Barrier Geometry – Navigable Passage and Auxiliary Flow Gates.....	192
Table 7-1:	SSB Summary for NYNJHAT Study Alternatives	193
Table 7-2:	Navigable Gates as RRFs for NYNJHAT study alternatives.....	194
Table 7-3:	Summary of Hackensack River RRF Navigable Gate Geometry – Navigable Passage and Auxiliary Flow Gates.....	197
Table 7-4:	Summary of Newtown Creek RRF Navigable Gate Geometry – Navigable Passage	200
Table 7-5:	Summary of Gowanus Canal RRF Navigable Gate Geometry – Navigable Passage	203
Table 7-6:	Summary of Sandy Hook Bridge RRF Navigable Gate Geometry – Navigable Passage and Auxiliary Flow Gates	206
Table 7-7:	Summary of Head of Bay Navigable RRF Gate Geometry – Navigable Passage and Auxiliary Flow Gates.....	209
Table 7-8:	Summary of Old Howard Beach East Gate RRF Navigable Gate Geometry – Navigable Passage.....	212
Table 7-9:	Summary of Old Howard Beach West Gate RRF Navigable Gate Geometry – Navigable Passage.....	215

List of Figures

Figure 1-1:	Schematic Plan View of a Storm Surge Barrier Modified after Mooyaart and Jonkman (2017).....	23
Figure 1-2:	Plan Overview of All Storm Surge Barriers Included Within the NYNJHAT Study Area.....	25

Figure 2-1:	NYNJ Harbor & Tributaries Study Area.....	34
Figure 2-2:	Verrazzano Narrows SSB Plan and Known Utility Zones Highlighted.....	41
Figure 2-3:	Jamaica Bay SSB Plan and Known Utility Zones Highlighted.....	41
Figure 2-4:	Percentage of Occurrence for Wind Speed in knots for John F. Kennedy International Airport (Station KJFK) for a 22-year period	57
Figure 2-5:	Percentage of Occurrence for Wind Speed in knots for La Guardia Airport (Station KLGA) for a 38-year period.....	58
Figure 2-6:	Percentage of Occurrence for Wind Speed in knots for Linden Airport, NJ (Station KLDJ) for a 10-year period	60
Figure 3-1:	Area of Interest for the Verrazzano Narrows Storm Surge Barrier Which Spans from Staten Island to Brooklyn (NY)	74
Figure 3-2:	SSB Without Headwall (top panel) and SSB with Headwall (lower panel) Shown in Both Open (left) and Closed (right) Configuration.....	77
Figure 3-3:	Schematic of Temporary Channel Relocation at Verrazzano Narrows SSB	86
Figure 3-4:	Floating Sector Gate Dry Dock	98
Figure 3-5:	Floating Sector Gate Sill	99
Figure 3-6:	Diagram of Scour Protection for the Floating Sector Gate	104
Figure 3-7:	A Vertical Lift Gate at Verrazzano Narrows – Isometric View.....	106
Figure 4-1:	Area of Interest for Jamaica Bay Storm Surge Barrier	108
Figure 4-2:	A Vertical Lift Gate at Jamaica Bay – Isometric View.....	117
Figure 5-1:	Area of Interest for the Hackensack Storm Surge Barrier Which Spans the Hackensack River in New Jersey	119
Figure 5-2:	Area of Interest for the Hackensack Storm Surge Barrier Which Spans the Hackensack River in New Jersey	120
Figure 5-3:	One of Five Vertical Lift Gates at the Hackensack River SSB – Isometric View	123
Figure 6-1:	Outer Harbor Storm Surge Barrier Location and Bathymetry	127
Figure 6-2:	Conceptual Geometry of the Outer Harbor Storm Surge Barrier – Section 1 of 5.....	128
Figure 6-3:	Conceptual Geometry of the Outer Harbor Storm Surge Barrier – Section 2 of 5.....	129
Figure 6-4:	Conceptual Geometry of the Outer Harbor Storm Surge Barrier – Section 3 of 5.....	130
Figure 6-5:	Conceptual Geometry of the Outer Harbor Storm Surge Barrier – Section 4 of 5.....	131
Figure 6-6:	Conceptual Geometry of the Outer Harbor Storm Surge Barrier – Section 5 of 5.....	132
Figure 6-7:	Throgs Neck Storm Surge Barrier Location and Bathymetry	135
Figure 6-8:	Conceptual Geometry of the Throgs Neck Storm Surge Barrier	137
Figure 6-9:	Arthur Kill Storm Surge Barrier Location and Bathymetry.....	139
Figure 6-10:	Conceptual Geometry of the Arthur Kill Storm Surge Barrier	141
Figure 6-11:	Potential Alternative Arthur Kill Alignments (A and B) (to be evaluated in the next phase).....	144
Figure 6-12:	Kill Van Kull Storm Surge Barrier Proposed Location and Bathymetry.....	145
Figure 6-13:	Conceptual Geometry of the Kill Van Kull Storm Surge Barrier	146
Figure 6-14:	Kill Van Kull Alignment C	148

Figure 6-15: Kill Van Kull Alignment D.....	148
Figure 6-16: Newtown Creek Storm Surge Barrier Approximate Location.	149
Figure 6-17: Conceptual Geometry of Gates of the Newtown Creek Storm Surge Barrier.....	151
Figure 6-18: Gowanus Canal Storm Surge Barrier Location and Bathymetry	153
Figure 6-19: Conceptual Geometry of Gates of the Gowanus Canal Storm Surge Barrier	155
Figure 6-20: Flushing Creek Storm Surge Barrier Location and Bathymetry	157
Figure 6-21: Conceptual Geometry of Gates of the Flushing Creek Storm Surge Barrier	159
Figure 6-22: Sheepshead Bay Storm Surge Barrier Approximate Location.	161
Figure 6-23: Conceptual Geometry of Gates of the Sheepshead Bay Storm Surge Barrier	163
Figure 6-24: Gerritsen Creek Storm Surge Barrier Approximate Location.....	165
Figure 6-25: Conceptual Geometry of Gates of the Gerritsen Creek Storm Surge Barrier	167
Figure 6-26: Eastchester Creek Storm Surge Barrier Approximate Location	169
Figure 6-27: Conceptual Geometry of Gates of the East Chester Creek Storm Surge Barrier.....	171
Figure 6-28: Port Washington Storm Surge Barrier Approximate Location	173
Figure 6-29: Conceptual Geometry of Gates of the Port Washington Storm Surge Barrier.....	175
Figure 6-30: Hempstead Harbor (Glen Cove) Storm Surge Barrier Approximate Location	177
Figure 6-31: Conceptual Geometry of Gates of the Hempstead Harbor Storm Surge Barrier.....	179
Figure 6-32: Hammond Creek Storm Surge Barrier Approximate Location.....	181
Figure 6-33: Conceptual Geometry of Gates of the Hammond Creek Storm Surge Barrier	183
Figure 6-34: Highlands Storm Surge Barrier Approximate Location.....	185
Figure 6-35: Conceptual Geometry of Gates of the Highlands Storm Surge Barrier	187
Figure 6-36: Raritan River Storm Surge Barrier Approximate Location.....	189
Figure 6-37: Conceptual Geometry of Gates of the Raritan River Storm Surge Barrier	191
Figure 7-1: Conceptual Geometry of Gates of the Hackensack River RRF Navigable Gate	196
Figure 7-2: Conceptual Geometry of Gates of the Newtown Creek RRF Navigable Gate	199
Figure 7-3: Conceptual Geometry of Gates of the Gowanus Canal RRF Navigable Gate	202
Figure 7-4: Sandy Hook Bridge Navigable Gate RRF, Approximate Location	204
Figure 7-5: Conceptual Geometry of Gates of the Sandy Hook Bridge RRF Navigable Gate	205
Figure 7-6: Head of Bay Navigable Gate RRF, Approximate Location.....	207
Figure 7-7: Conceptual Geometry of Gates of the Head of Bay Gate RRF Navigable Gate	208
Figure 7-8: Howard Beach East (and West) Navigable Gate RRF, Approximate Location...	210
Figure 7-9: Conceptual Geometry of Gates of the Old Howard Beach East Gate RRF Navigable Gate.....	211
Figure 7-10: Conceptual Geometry of Gates of the Old Howard Beach West Gate RRF Navigable Gate.....	214

List of Annexes

- Annex A Navigation Analysis, Minimum Gate Width, and Gate Type Selection
- Annex B Crest Elevations
- Annex C Water Level Rise on the Interior
- Annex D Closure Frequency and Closure Duration
- Annex E Memo Closure Orchestration Preliminary/Draft Water Control Plan Outline
- Annex F Supporting MAP per SSB Structure
- Annex G Verrazzano Narrows Storm Surge Barrier Plan Set
- Annex H Hackensack River Storm Surge Barrier Plan Set
- Annex I Navigation Stakeholder Engagement Report

Glossary

Term/Acronym	Expanded	Definition
ADCIRC model	ADvanced CIRCulation model	Computational model for predicting wind, wave, and storm surge conditions of tropical and extratropical cyclones.
AdH Model	Adaptive hydraulics model	A high-fidelity computational tool capable of simulating estuarine and riverine flows, hydrodynamics in reservoirs, and lakes, flows due to dam and levee breaches, continental scale flows, flows due to compound flooding, non-hydrostatic free surface flows, and all associated transport phenomenon.
ADM	USACE Agency Decision Milestone	
AEP	Annual Exceedance Probability	The probability that at least one event in excess of a particular magnitude will occur in any given year.
Aesthetic valuation		A judgement of value based on appearance of an object or emotional response.
AIS	Automatic Identification System	Vessel traffic data, or Automatic Identification System (AIS) data, are collected by the U.S. Coast Guard through an onboard navigation safety device that transmits and monitors the location and characteristics of vessels in U.S. and international waters in real time.
AISC	American Institute of Steel Construction	
AMM	USACE Alternatives Milestone Meeting	
ASA(CW)	Assistant Secretary of the Army (Civil Works)	An office of the United States Department of the Army responsible for overseeing the civil functions of the United States Army.
ASD	Allowable Stress Design	Allowable Stress Design (ASD) is also referred to as the service load design or working stress design. The basic conception (or design philosophy) of this method is that the maximum stress in a structural member is always smaller than a certain allowable stress in working or service conditions.
ATR	Agency Technical Review	
BCR	Benefit to Cost Ratio	
CBRA	Coastal Barrier Resources Act	
CERCLA	Comprehensive Environmental Response, Compensation, and Liability Act	
CFR	Code of Federal Regulations	
closure criterion		The forecast water level for which operation of the storm surge barrier is authorized. For this study, this is assumed to be +7 feet NAVD 88.

Term/Acronym	Expanded	Definition
closure elevation		The observed water level at which the mechanical procedure to close storm surge barrier gates is executed.
CSO	Combined Sewage Outfalls	
CSRMA	Coastal Storm Risk Management	
CZMA	Coastal Zone Management Act	
Deepwater ecosystems	Coastal ecosystems with bed elevation between -2m and -20m below Mean Sea Level (MSL)	
DOI	Department of Interior	An executive department of the U.S. Government responsible for the management and conservation of most federal lands and natural resources.
DRSAA	Disaster Relief Supplemental Appropriations Act	
EFH	Essential Fish Habitat	
EIS	Environmental Impact Statement	
EJ	Environmental Justice	
elevation		The height of an object relative to an established datum, such as mean sea level.
EOP	Environmental Operating Principles	
EPA	Environmental Protection Agency	
EQ	environmental quality	
ERDC	U.S. Army Engineer Research and Development Center	
ESA	Endangered Species Act	
Estuarine Ecosystems	Coastal ecosystems with salinity from 0.5 to 28 ppt	
ESI	Environmental Sensitivity Index for shorelines from the National Oceanic and Atmospheric Administration	
FCSA	Fiscal Cost Share Agreement	
FEMA	Federal Emergency Management Agency	
FIRM	Flood Insurance Rate Map	
Freshwater Ecosystems	Coastal ecosystems with low salinity < 0.5 ppt	
FWOP	future without project	
FWOPC	future without project condition(s)	
FWP	future with project	
FWPC	future with project condition(s)	
GIS	Geographic Information System	
HEC-FDA	Hydraulic Engineering Center Flood Damage Reduction Analysis	USACE software used to assess economic benefits of flood protection projects.
HR	Hudson River	

Term/Acronym	Expanded	Definition
HTRW	Hazardous, Toxic, and Radioactive Waste	
HUC	Hydrologic Unit Code	
IFF	Induced Flooding Mitigation Feature ¹	Features used to offset the impacts of increased water levels due to the presence of a storm surge barrier.
IMPLAN	Impact analysis for PLANning	A software and database program that estimates input-output models based on data and assumptions of social accounting and multipliers.
Intertidal Ecosystems	Coastal ecosystems with bed elevation between Mean Higher High Water (MHHW) and Mean Lower Low Water (MLLW)	
IPCC	Intergovernmental Panel on Climate Change	
IPR	In-Progress Review	
IWR	Institute for Water Resources	
JB	Jamaica Bay	
LRFD	Load and Resistance Factor Design	The Load and Resistance Factor Design (LRFD) method is based on a combination of factoring applied loads up as a function of loading predictability and factoring the component resistance (nominal strength) down as a function of reliability and importance.
Marine Ecosystems	Coastal ecosystems with low salinity ≥ 28 ppt	
MBTA	Migratory Bird Treaty Act	
MHHW	Mean Higher High Water	The average of the higher high-water height each tidal day observed over AdH simulation period.
MLLW	Mean Lower Low Water	The average of the lower low-water height each tidal day observed over AdH simulation period.
MMPA	Marine Mammal Protection Act	
MSA	Magnuson-Stevens Fishery Conservation and Management Act	
MSL	mean sea level	
NACCS	North Atlantic Coast Comprehensive Study	
NAVD88	North American Vertical Datum of 1988	The vertical control datum established in 1991 by the minimum-constraint adjustment of the Canadian–Mexican–United States leveling observations.
NED	National Economic Development	
NEPA	National Environmental Policy Act	
NJ	New Jersey	

¹ Formerly also referred to as induced flooding feature.

Term/Acronym	Expanded	Definition
NJDEP	New Jersey Department of Environmental Protection	
NLT	no later than	
NMFS	National Marine Fisheries Service	
NNBF	Natural and Nature-based Feature	Landscape features that are used to provide engineering functions relevant to flood risk management, while producing additional economic, environmental, and/or social benefits. Examples of NNBF include beaches and dunes; vegetated environments such as maritime forests, salt marshes, freshwater wetlands and fluvial flood plains, and seagrass beds; coral and oyster reefs, barrier islands, among others.
NOAA	National Oceanic Atmospheric Administration	
Nonstructural Measure		Permanent or contingent (deployable, or temporary) measures applied to a structure and/or its contents that prevent or provide resistance to damage from flooding.
NPS	National Park Service	
NWS	National Weather Service	
NY	New York (State)	
NYBEM	New York Bight Ecological Model	
NYC	New York City	
NYDOS	New York Department of State	
NYNJHAT	New York New Jersey Harbor and Tributaries	
NYNJHAT	New York New Jersey Harbor and Tributaries Study	
NYSDEC	New York State Department of Environmental Conservation	
OFC	other first costs	
OHSIM	Oyster Habitat Suitability Index Model	
OMRR&R	Operations, Maintenance, Repair, Rehabilitation & Replacement	
OSE	other social effects	
PDT	Project Delivery Team	
PED	Preconstruction, Engineering, and Design	
ppt	parts per thousand	
RECONS	Regional ECONomic System	A model designed to provide estimates of regional economic impacts and contributions associated with USACE projects, programs, and infrastructure across Corps Civil Works business lines.
RED	Regional Economic Development	
REMI	Regional Economic Model, Inc.	Input/output regional economic model.

Term/Acronym	Expanded	Definition
RRF	Risk Reduction Feature ²	Features to reduce the residual coastal flood risk prior to closure of a given storm surge barrier.
RSLC	relative sea level change	
S&A	State and Agency (Review)	
SAV	Submerged Aquatic Vegetation	
SBM	Shore-based Measure	On-land perimeter measures such as levees, floodwalls, dunes, promenades, etc., that are constructed to impede coastal storm surge.
SSB	Storm Surge Barrier	In-water measure consisting of navigable and, where applicable, auxiliary gates which can be opened and closed to impede storm surge from entering an area vulnerable to coastal flooding.
SSPC	Society for Protective Coatings	
Still Water Overtopping		The process of water flowing over the crest of a coastal structure, such as a seawall, a dike, or a breakwater, due to still water only.
STP	Sewage Treatment Plant	
Structural Measure		Permanent measures that prevent or provide resistance to damage from flooding. Also called "grey infrastructure."
Subtidal Ecosystems	Coastal ecosystems with bed elevation between Mean Lower Low Water (MLLW) and -2m below Mean Sea Level (MSL)	
SWL	Still Water Level	Average water surface elevation at any instant, excluding local variation due to waves and wave set-up, but including the effects of tides, storm surges and long period seiches.
TEU	Twenty-foot Equivalent Unit	A unit of cargo capacity generally used for container ships and container handling facilities.
TSP	Tentatively Selected Plan	
US	United States	
USACE New York District	U.S. Army Corps of Engineers North Atlantic Division New York District	
USACE North Atlantic Division	U.S. Army Corps of Engineers North Atlantic Division New York District	
USFWS	U.S. Fish & Wildlife Service	
USGS	U.S. Geological Survey	
VN	Verrazano Narrows	
VT	Vertical Team	USACE internal project team consisting of members across all three levels of USACE: district, division, and HQ.

² Formerly also referred to as residual risk feature.

Term/Acronym	Expanded	Definition
Wave Overtopping		The process of water flowing over the crest of a coastal structure, such as a seawall, a dike, or a breakwater, due to wave action.
Wave Runup		Wave run-up is the maximum onshore elevation reached by waves, relative to the shoreline position in the absence of waves.
WPCP	Water Pollution Control Plant	
WRDA	Water Resources Development Act	A series of acts, usually biannual, which authorize funding for a variety of studies and projects, including beach nourishment, clean water, and flood control programs.
WSE/WSEL	Water Surface Elevation	
WWTP	Wastewater Treatment Plant	

Page left intentionally blank.

1 Introduction

1.1 Project Overview

1.1.1 The Study

The North Atlantic Coast Comprehensive Study (NACCS) was conducted to address the flood risk to vulnerable coastal populations in areas that were affected by Hurricane Sandy within the boundaries of the North Atlantic Division of the United States Army Corps of Engineers (USACE). The New York/New Jersey Harbor and Tributaries (NYNJHAT) area was identified as a “focus area” within the NACCS study. The study purpose is to determine the feasibility of coastal storm risk management (CSRM) in the NYNJHAT study area, and to recommend a plan that will contribute to community and environmental resilience.

The study area encompasses the New York Metropolitan Area, including the most populous and densely populated city in the United States, and the six most populated cities in New Jersey. The shorelines of some of the NYNJHAT study area are characterized by low elevation areas, developed with residential and commercial infrastructure that are subject to coastal flood risk. The study area covers more than 2,150 square miles and comprises parts of 25 counties in New Jersey and New York. During coastal storms, storm surges are generated on the open coast and propagate through New York Harbor or through Long Island Sound and flood the extensive low-lying areas surrounding the metropolitan area.

1.1.2 Organization of Engineering Analyses

The analysis and documentation of the engineering studies and analyses completed in support of NYNJHAT Study are extensive. The Engineering Appendix to the Feasibility Study report discusses the engineering and design work conducted to layout and evaluate potential structural and nonstructural solutions to manage coastal storm risk in study area.

A key component of the Feasibility Study (that is documented in the Engineering Appendix) is the conceptual layout for various coastal storm risk management measures. Structural measures such as storm surge barriers, levees, floodwalls, seawalls, etc., and nonstructural measures are included in the array of alternatives. The purpose of the structural measures is to form a flood risk reduction system and to be an integral part of each alternative’s CSRM strategy to impede storm surge propagation and reduce the risk of flooding for the area behind it.

The engineering appendix is limited to a description of structural measures and nonstructural measures only, albeit that it is recognized that the study alternatives include more measures (i.e., Natural and Nature-based Features). Specifically, the engineering appendix is organized around the principal distinction between storm surge barriers and shore-based measures. Storm surge barriers (SSBs) are the large in-water, gated, navigable barriers which are unique civil works on their own (see also Section 1.2). Shore-based measures (SBMs) are the typical flood risk reduction features on land that combine to form a reach of the coastal storm risk management system. In other words, shore-based measures are the collective of all structural CSRM measures other than storm surge barriers.

This Storm Surge Barrier Sub-Appendix contains a technical description and narrative to support the conceptual design of the storm surge barriers and includes documentation of the general design criteria of these navigable, in-water structures. Furthermore, the sub-appendix is part of the engineering appendix that includes descriptions of engineering studies and analyses in support of the NYNJHAT Study as laid out in Table 1-1. The reader is referred to the main Engineering Appendix for an overview of all engineering analyses and studies and referred to the Shore-Based Measures Sub-Appendix for a detailed description of the design development of the shore-based measures that are part of the study alternatives.

Table 1-1: NYNJHAT CSRM Feasibility Study Engineering Appendix and Sub-Appendices

Appendix	Sub-Appendix	Contents/Subject
Engineering Appendix		Engineering appendix to the Feasibility Study Report Documenting conceptual designs of all structural measures that are part of this coastal storm risk management study.
	SSB Sub-Appendix	Conceptual Design for Storm Surge Barriers that are part of the study alternatives, with emphasis on a conceptual design for the Verrazzano Narrows, Jamaica Bay, and Hackensack River Storm Surge Barriers.
	SBM Sub-Appendix	The Structural Coastal Storm Risk Management (CSRM) shore-based measures evaluated as part of the Study.

1.2 Storm Surge Barrier Sub-Appendix Content

1.2.1 Scope

The scope of this sub-appendix is to introduce the storm surge barriers and navigable gates, the location of these structures and provide detail on which structures are included in each study alternative. Furthermore, the content of this sub-appendix provides a narrative on the design development and presents the conceptual design and geometric characteristics of the storm surge barriers. This information is then used to develop cost estimates for each structure and the project alternatives, which is documented separately in the Cost Engineering Appendix. The following sections first provide context and a general definition of a storm surge barrier, after which all storm surge barriers under considerations are briefly introduced.

1.2.2 Perimeter Flood Risk Reduction vs. Coastal Barriers

1.2.2.1 General

A typically employed solution for reducing flood risk is to raise the level of existing perimeter flood risk reduction systems. This solution can be challenging to implement in geometrically constrained urbanized areas where waterfront spaces have multiple uses and serve a variety of stakeholders such that social and economic impacts could be considerable. In large bays, estuaries, natural harbors, port entrance channels, and coastal barriers constructed as integral parts of a flood

risk reduction system can be a cost-effective alternative to reduce the risk of flooding for the area. As such, the NYNJHAT Study includes evaluation of coastal barriers, in combination with other flood risk reduction systems.

Generally, four primary types of coastal barriers are identified: **closure dams, storm surge barriers, tide gates, and tidal locks**. Closure dams permanently close off the connection between a coastal waterbody, such as an estuary or a bay, and the ocean. Closure dams eliminate the tidal connection and result in the formation of a manmade lake, effectively minimizing the chance of coastal storm surge induced floods for the area behind it. Due to the elimination of the tidal exchange, closure dams hinder navigation and introduce a steep gradient in environmental conditions across the structure, which are generally considered a substantial negative impact. For these reasons, closure dams are not considered under the NYNJHAT Study.

A storm surge barrier is a fully or partial movable barrier that includes operable elements (usually gates) that can be closed temporarily to impede storm surge generated by coastal storms and limit water levels in the basin, thereby reducing flood risk for low-lying coastal areas within the basin. Key characteristics of a storm surge barrier are that it allows for navigation to transit the barrier, and it maintains tidal exchange between the ocean and the newly created inner basin during normal hydrometeorological, i.e., non-storm conditions. Some examples of storm surge barriers are the Inner Harbor Navigation Canal storm surge barrier (New Orleans, LA), the New Bedford storm surge barrier (New Bedford, MA), and the Eastern Scheldt storm surge barrier (The Netherlands). For more examples, refer to the Interim Report in support of the NYNJHAT Study (USACE, 2019).

Tide gates³ or tide gate complexes are generally considered to be similar to storm surge barriers, with the exception that they do not provide for navigation. These structures provide a barrier between the ocean and a waterbody at a location that is considered or designed to be non-navigable. In most instances, such locations are inherently shallower in depth and smaller in span compared to storm surge barriers. As such, without any clearances needed to accommodate vessels tide gates, or tide gate complexes are in general relatively smaller structures and allow for tidal flow exchange and discharge of stream flows during normal conditions. These structures include operable gates that can be closed temporarily during storm conditions to impede storm surge and limit water levels in the waterbody behind it and provide flood risk reduction. In some instances, tide gates are accompanied by a pump station that is operated in the event of gate closure to discharge streamflows from the upstream waterbody and maintain safe water levels e.g., the 17th Street Canal Closure and Permanent Pump Station complex (New Orleans, LA).

Tidal locks or tidal lock complexes⁴ are structures that have the primary function to allow for the passage of vessels between tidal and non-tidal water and where operation is affected by the state of the tides. Notwithstanding the fact that some water exchange occurs with every lock cycle, these structures are generally not designed to accommodate full tidal flow exchange between the ocean

³ In some instances, tide gates are referred to as floodgates. However, floodgate is a more general term for a flood control structure that is not necessarily situated in the coastal plain. The term can be used to describe gated structures along rivers or structures on land that close off openings in flood risk reduction systems; hence, tide gate is the preferred term here to refer to a (tidally influenced) coastal barrier, as described herein.

⁴ In some instances, tidal locks are included within closure dams or storm surge barriers, and as such, “hybrid” coastal barriers that include components or characteristics of the four primary types exist.

and inland waterbody. When constructed in areas prone to storm surge and flood risk, coastal locks can be designed to tie in to, and be an integral part of the perimeter flood risk reduction system. Tidal locks are not considered under the NYNJHAT Study.

1.2.2.2 General Description of a Storm Surge Barrier with Navigable Passage

Mooyaart and Jonkman (2017) provide general design considerations and an overview of navigable storm surge barriers based on data and design documentation review of a select set of constructed storm surge barriers throughout the world (see Annex A). They also provide a general description of a storm surge barrier where a typical layout contains three elements: a gated section, a dam section, and a navigable passage. A navigable passage can either be established with a lock or with a gated navigable opening. The difference is that a lock passage is usually closed during normal operational conditions and only opens for the passage of vessels; a gated navigable passage is usually open for free navigation passage and only closed during the occurrence of a storm surge event. Figure 1-1 below provides a schematic plan view of a navigable storm surge barrier. The navigable passage is schematically shown as a gated opening not as a lock, since the storm surge barriers studied under the NYNJHAT Study require minimal interruptions of maritime traffic except during storm surge events. Figure 1-1 schematically shows a total of three (3) auxiliary flow gates; however, the storm surge barriers discussed herein may have fewer or many more. Both navigation and tidal flow exchange can be provided through the navigable passage opening. It is further recognized that not all storm surge barriers discussed herein resemble a large civil works structure that one typically associates with the term storm surge barrier.

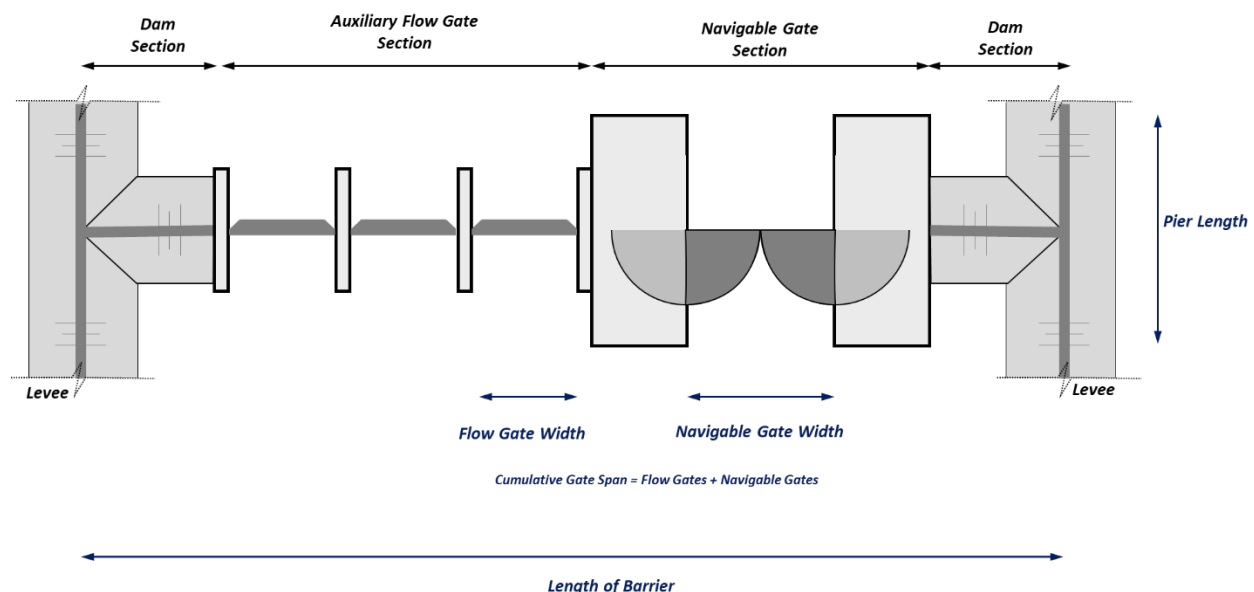

**Figure 1-1: Schematic Plan View of a Storm Surge Barrier
Modified after Mooyaart and Jonkman (2017)**

1.2.3 Navigable Storm Surge Barriers in the NYNJHAT Study Alternatives

The alignments of each of the NYNJHAT Study Alternatives were developed during the early plan formulation phase of the study (see also main body of the Feasibility Report). Refinements and alterations to the alternative SBM alignments were made over the course of the feasibility study

but were generally minor. In general terms, placement of the storm surge barrier was informed by the following assumptions and principles:

- Span across the waterbody to connect the perimeter-based flood risk reduction system and provide a near-perpendicular crossing of the federal navigation channel(s),
- The geologic and geotechnical site conditions are assumed to be generally uniform at each site, and as such, no specific area or corridor is preferred to minimize foundation cost,
- When practicable, the conceptual alignment should favor shallower portions of the waterbody/inlet to minimize foundation depths to the extent practical,
- When practicable, the start and end of the storm surge barrier alignments should favor sheltered coastlines to reduce overall wave energy exposure, and tie-in locations are suitable for landward extension of the storm surge barrier structure to connect to the shore-based perimeter flood risk reduction system,
- When practicable, the alignment should minimize the number of conflicts with submerged utilities, and other marine- and coastal-located features. It is required to provide barrier conceptual designs that minimize the total length of and changes in orientation to the extent practical, since as a general assumption, it is presumed that additional length or changes in orientation would increase the overall cost of the storm surge barrier system.

Following the above principles, the locations of the storm surge barriers discussed herein are, for the most part, determined by the extent and location of the perimeter flood risk reduction systems.

Over the course of the feasibility study, Induced Flooding mitigation Feature (IFF) alignments were added to each study alternative, where applicable. The concept of induced flooding risk is explained in the Engineering Appendix, but briefly reiterated here. IFFs are placed in areas where there is an increase in flood levels as a result of the proposed project. The locations for IFFs and the IFF alignments were based on the analysis of induced flooding for each of the study alternatives and is detailed in the SBM Sub-Appendix. In some instances, induced flooding was mitigated by extending the shore-based measures across a water body and in those locations a storm surge barrier was added to a study alternative as an IFF. Ultimately, 18 storm surge barrier structures were defined as part of the study alternatives (see Table 1-2) to mitigate flood risk for the 1% Annual Exceedance Probability (AEP) coastal flood event. These 18 storm surge barriers, also referred to as “primary navigable barriers”, are shown in Figure 1-2.

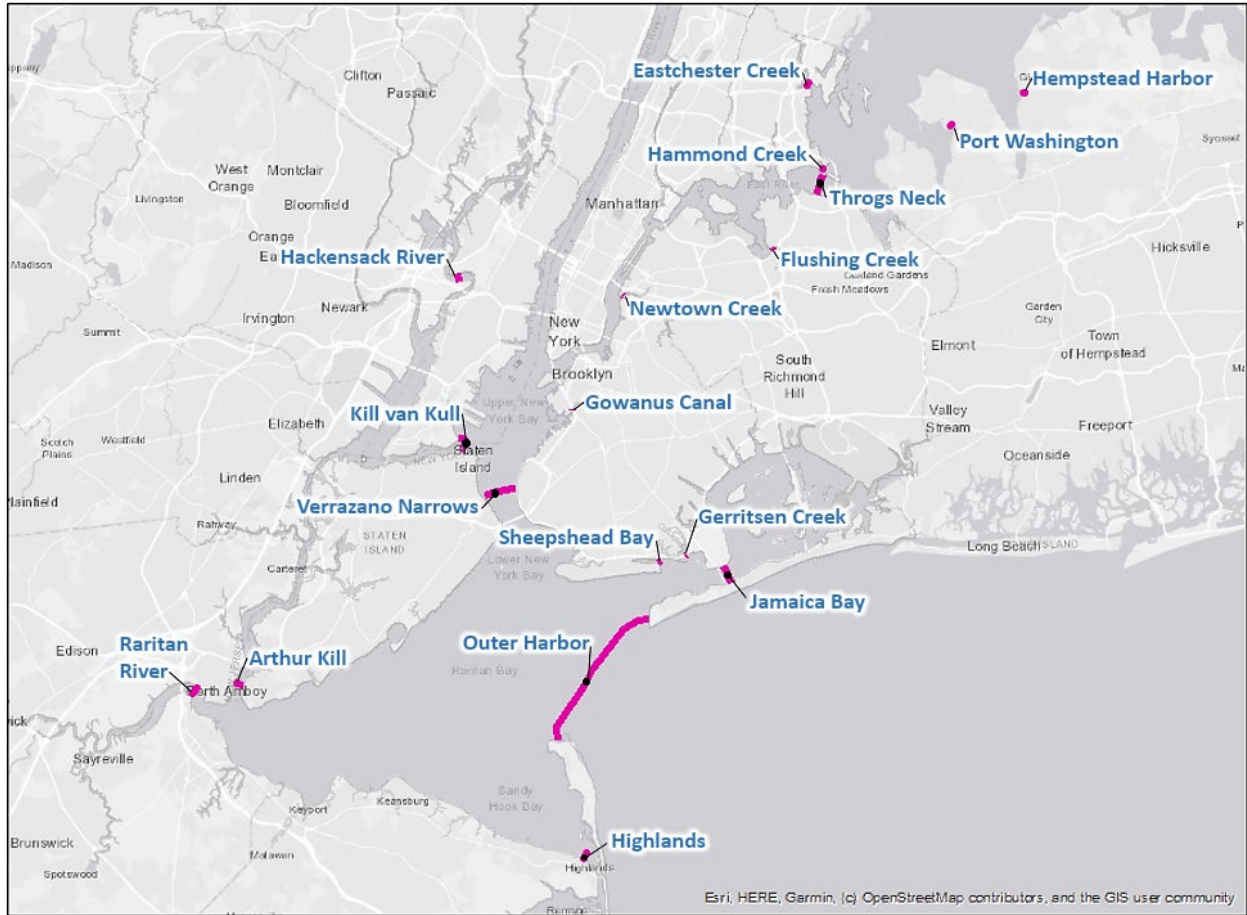

Figure 1-2: Plan Overview of All Storm Surge Barriers Included Within the NYNJHAT Study Area

Table 1-2: Storm Surge Barriers (Primary Navigable Barriers) for NYNJHAT Study Alternatives

Name of Storm Surge Barrier	Abbr.	Alt. 2	Alt. 3A	Alt. 3B	Alt. 4	Alt. 5	RRFs in Basin	Strict Constrained Operation (SCO) or Moderately Constrained Operation (MCO)
Storm Surge Barriers								
Outer Harbor	OH	YES					Yes	SCO
Throgs Neck	TN	YES	YES				Yes	SCO
Verrazzano Narrows	VN		YES				Yes	SCO
Arthur Kill	AK		YES	YES			Yes	SCO
Jamaica Bay	JB		YES	YES	YES		Yes	SCO
Kill Van Kull	KVK			YES			Yes	SCO
Hackensack River	HR				YES		No	MCO
Newtown Creek	NC			YES	YES		No	MCO
Gowanus Canal	GC			YES	YES		No	MCO
Flushing Creek	FC			YES	YES		No	MCO
Sheepshead Bay	SB		YES	YES	YES		No	MCO
Gerritsen Creek	GRC		YES	YES	YES		No	MCO
Induced Flooding Mitigation Features								
Eastchester Creek	EC	YES	YES				No	MCO
Port Washington	PW	YES	YES				No	MCO
Hempstead Harbor	HH	YES	YES				No	MCO
Hammond Creek	HC	YES	YES				No	MCO
Highlands	HL		YES				No	MCO
Raritan River	RR		YES				No	MCO

For the larger storm surge barrier structures that accommodate deep-draft navigation or intersect major shipping routes, the operational frequency is expected to be considerably constrained. This is indicated by the keyword “Strict Constrained Operation” (SCO) in the last column of Table 1-2, i.e., the storm surge barrier gates will only be closed for the more severe coastal storm events such that navigation is not negatively impacted. In the alternatives where these six storm surge barriers (OH, TN, VN, AK, KVK, JB) are proposed (Alternatives 2, 3A, 3B, and 4), complementary RRFs to manage the risk of more frequent flooding are proposed for developed, non-natural areas, as indicated in Table 1-2. Shorelines protected by these 6 SSBs would still face residual risk from flooding events that may not be large enough to trigger an SSB closure. As such, the need for RRFs is directly correlated to the assumed inability to operate these major storm surge barriers frequently. The residual flood risk for the coastal areas upstream of the other storm surge barriers is mitigated by a lower closure elevation – that is, operation is only moderately constraint (MCO).

Thus, more frequent operation is assumed to be possible for these storm surge barriers and no complementary RRFs are needed. RRFs are typically small floodwalls and berms, amongst others, but at a few specific instances RRFs are proposed to cross existing waterways that are navigable. For these locations, a navigable gate was selected as an assumed cost-effective alternative to many miles of land-based RRF features along the water’s edge to reduce the risk of residual flooding.

These navigable gates are considered secondary features – that is, not storm surge barriers that provide the primary flood risk reduction function, but due to their similarity as navigable gate structure are discussed herein together with the SSBs.

Table 1-3: Summary of RRF Navigable Barriers (Secondary Navigable Barriers) per Alternative

Name of Navigable Barrier	Abbr.	Alt. 2	Alt. 3A	Alt. 3B	Alt. 4	Alt. 5
Hackensack River RRF	HR RRF	YES	YES	YES		
Newtown Creek RRF	NC RRF	YES	YES			
Gowanus Canal RRF	GC RRF	YES	YES			
Sandy Hook Bridge RRF	SHB RRF	YES				
Head of Bay Gate RRF	HB RRF	YES	YES	YES	YES	
Old Howard Beach East Gate RRF	OHBE RRF	YES	YES	YES	YES	
Old Howard Beach West Gate RRF	OHBW RRF	YES	YES	YES	YES	

1.3 Organization

1.3.1 Reader’s Guide

As explained under Section 1.2.1, this sub-appendix includes the documentation of the general design criteria and first conceptual designs of navigable storm surge barriers, which are part of the alternatives considered under the NYNJHAT Study. In addition, this sub-appendix also includes the conceptual designs of the navigable barriers that are part of the RRFs. The storm surge barriers are listed in Table 1-4 and presented on a map in Figure 1-2, and the RRF navigable barriers are listed in Table 1-3.

It is recognized that storm surge barriers are complex civil works, and that this complexity translates into large contingencies on the cost estimates of such structures. This is especially the case if the level of design is conceptual, which is typical during the feasibility phase of a project. Since the NYNJHAT Study Alternatives include multiple storm surge barriers, there was a need to provide more detail on the storm surge barriers such that contingencies could be lowered. To that end, feasibility level designs for three selected reference storm surge barriers – Verrazzano Narrows, Jamaica Bay, and Hackensack River – were completed, consistent with the objective of achieving a Class 4 cost estimate. Using the Class 4 cost estimates for the three selected reference SSBs, the project delivery team (PDT) has then scaled and extrapolated the costs for the other storm surge barriers under consideration. More specific details on cost estimates are provided in the Cost Engineering Appendix.

Following the above-described methodology, this sub-appendix is organized to provide a basis of design for all storm surge barriers that are part of the NYNJHAT Study⁵ (section 1.2.3). Then, the design development of the three selected referenced storm surge barriers – Verrazzano Narrows, Jamaica Bay, and Hackensack River storm surge barriers – are described in Sections 3, 4, and 5. Detailed plan sets for these structures are included as supporting materials to the Engineering Appendix. For the remainder of the storm surge barriers, an engineering basis is provided to establish the overall geometry, the minimum practical dimensions of the barrier openings (both navigational and auxiliary), and a preliminarily selected gate type (or gate types).

All of this information is contained within Section 6 where each sub section provides a conceptual design summary of each storm surge barrier (see also Table 1-4). For the navigable gates that are part of the RRFs a similar approach was followed and Section 7 provides a conceptual design summary of each RRF navigable gate (Table 1-4). Recommendations for further study are documented in Section 8. The information provided in Section 6 and Section 7 is used to develop cost estimates for each of these structures and details are provided in the Cost Engineering.

⁵ For the three reference storm surge barriers some additional design basis details are provided when warranted

Table 1-4: Storm Surge Barriers and Navigable Gates and Reader’s Guide

Name of Feature	Study Alternative	Section within this Sub-Appendix that provides Conceptual Design Summary
Storm Surge Barriers – Primary Navigable Barriers		
Verrazzano Narrows	3A	3
Jamaica Bay	3A, 3B, 4	4
Hackensack River	4	6.8.20
Outer Harbor	2	6.3
Throgs Neck	2, 3A	6.4
Arthur Kill	3A, 3B	6.6
Kill Van Kull	3B	6.8
Newtown Creek	3B, 4	6.10
Gowanus Canal	3B, 4	6.11
Flushing Creek	3B, 4	6.12
Sheepshead Bay	3A, 3B, 4	6.13
Gerritsen Creek	3A, 3B, 4	6.14
Induced Flooding Mitigation Features – Primary Navigable Barriers		
Eastchester Creek	2, 3A	6.15
Port Washington	2, 3A	6.16
Hempstead Harbor (Glen Cove)	2, 3A	6.17
Hammond Creek	2, 3A	6.18
Highlands	3A	6.19
Raritan River	3A	6.20
Risk Reduction Features – Secondary Navigable Barriers		
Hackensack River RRF	2, 3A, 3B	7.2
Newtown Creek RRF	2, 3A	7.3
Gowanus Canal RRF	2, 3A	7.4
Sandy Hook Bridge RRF	2	7.5
Head of Bay Gate RRF	2, 3A, 3B, 4	7.6
Old Howard Beach East Gate RRF	2, 3A, 3B, 4	7.7
Old Howard Beach West Gate RRF	2, 3A, 3B, 4	7.8

1.3.2 Limitations

The appendix includes a technical narrative that supports the development of the conceptual layout and design of the storm surge barriers that are part of the feasibility study’s alternatives. The level of detail of the proposed concepts is commensurate with that of a feasibility study. Given the size of the study area and number and locations of storm surge barriers, the level of design is generally conceptual. Additional level of detail has been added where needed to reduce uncertainties, specifically as explained earlier, for the three referenced storm surge barriers. For all other storm surge barriers, the design development focuses on the primary features of each storm surge barrier complex and include the approximate size of the gate opening, structure height and general geometry, the number and size of the navigable gates, and the number and size of auxiliary flow gates. It can be noted that a number of the storm surge barriers presented herein span a fairly narrow waterway and may not include auxiliary flow gates in addition to the navigable passage. In such instances, tidal flow exchange will occur through the navigable passage. The objective at this stage is to provide sufficient detail for each study alternative such that cost estimates can be developed and alternatives can be compared.

1.4 Prior Studies and Reports

Before presenting the technical details and design development of the storm surge barriers, it is recognized that there are several visioning studies, reports, and presentations that have addressed the concept of storm surge barriers for the larger New York Metropolitan Area. These reports have been used, to the extent practical, to inform the data presented herein. Amongst other relevant reports and publications, it includes the numbered items below:

- 1) L. Smith (2005), Closing the Doors on Storm Surge, *Coastlines*, vol. 34, no. 1, pp. 6-7. (Smith, 2005)
- 2) Bowman et al. (2004) Hydrologic Feasibility of Storm Surge Barriers to Protect the Metropolitan New York – New Jersey Region – Summary Report. (Bowman, et al., 2004)
- 3) Bowman, M., Hill, D., Buonaiuto, F., Colle, B., Flood, R., Wilson, R., Hunter, R. and Wang, J. (2008) ‘Threats and Responses Associated with Rapid Climate Change in Metropolitan New York’, in M. McCracken, F. Moore, J. C. Topping (Jr.) (eds) *Sudden and Disruptive Climate Change: Exploring the Real Risks and How We Can Avoid Them*, Earthscan, London pp119–142 (Bowman, et al., 2008)

Concepts for the storm surge barrier at the Verrazzano Narrows, Arthur Kill, Outer Harbor, and Throgs Neck locations in particular were presented at a seminar titled “Against the Deluge: Storm Surge Barriers to Protect New York City”, which was held on March 30th and 31st 2009 at the Polytechnic Institute of NYU:

- 1) Hill, D. (ed) (2011) *Against the Deluge: Storm Surge Barriers to Protect New York City*, Conference Proceedings, Polytechnic Institute of New York University, Brooklyn, NY, 30–31 March 2009, *Annals of the New York Academy of Sciences*, New York, NY (Hill, 2013)

Other relevant papers and reports that address the topic more broadly for the New York Metropolitan Area include:

- 2) Dircke, P. T. M., T. H. G. Jongeling, and P. L. M. Jansen. 2012. “Navigable Storm Surge Barriers for Coastal Cities: An Overview and Comparison”. In *Climate Adaptation and Flood Risk in Coastal Cities*, by J Aerts, W Botzen, M Bowman, P Ward and P Dircke, 201-223. New York: Earthscan. (Dircke, Jongeling, & Jansen, 2012).
- 3) Aerts, J.C.J.H., W.J. Botzen, and H De Moel. 2013. *Cost Estimates for Flood Resilience and Protection Strategies in New York City*. New York: Annals of the New York Academy of Sciences. (Aerts, De Moel, & Botzen, 2013).

Papers and reports that provide an overview of gate types utilized in storm surge barriers and/or address the general approach to assess the feasibility of storm surge barriers in particular settings include:

- 4) PIANC. 2006. *Design of Movable Weirs and Storm Surge Barriers*. Brussels, Belgium: PIANC. (PIANC, 2006).
- 5) Mooyaart, Leslie F, Sebastiaan N Jonkman, Peter A. L. de Vries, Ad van der Toorn, and Mathijs van Ledden. 2014. ““Storm Surge Barrier: Overview And Design Considerations”.” Edited by Patrick J. Lynett. *Coastal Engineering Proceedings*. Seoul, Korea: Coastal Engineering Research Council. 808. (Mooyaart L. F., Jonkman, de Vries, van der Toorn, & van Ledden, 2014).
- 6) Mooyaart L.F., Jonkman S.N., *Overview and Design Considerations of Storm Surge Barriers*. *ASCE Journal of Waterway, Port, Coastal, and Ocean Engineering*, Vol. 143, Issue 4. (Mooyaart & Jonkman, 2017).
- 7) van Ledden, Mathijs, A.J. Lansen, H.J. de Ridder, and B. Edge. 2012. ““Reconnaissance level study Mississippi Storm Surge Barrier”.” Edited by Patrick Lynett and Jane McKee Smith. *Proceedings of 33rd Conference on Coastal Engineering*. Santander, Spain: Coastal Engineering Research Council. (van Ledden, Lansen, de Ridder, & Edge, 2012).

For both the Jamaica Bay and Hackensack River storm surge barriers, detailed feasibility studies were previously completed, as described below:

There are two previous studies that investigated storm surge barriers for Jamaica Bay:

1. USACE-WES (1976). *Technical Report H-76-14 Effects of Hurricane Surge Barrier on Hydraulic Environment, Jamaica Bay, New York — Hydraulic Model Investigation*. Hydraulics Laboratory, US Army Engineer Waterways Experiment Station, September 1976. (USACE-WES, 1976).

2. USACE-NAN (2016). Atlantic Coast of New York, East Rockaway Inlet to Rockaway Inlet and Jamaica Bay. Final Hurricane Sandy General Reevaluation Report and Environmental Impact Statement. Engineering Appendix A – 2, 2018. (USACE, 2018)

These documents have been used to inform the data presented herein and are referenced in the relevant sections. Albeit the 1976 USACE-WES report contains very useful data and is a valuable study in many regards, the storm surge barrier alternatives, all in very close vicinity to the Gil Hodges Bridge, studied within that report had only a limited number of openings and would restrict the inlet to about one-third of the existing condition. Reduction in the cross-sectional area resulted in increased velocities within the navigation channel and a reduction in tidal amplitude. The NYNJHAT Study seeks to minimize the impact on tidal flow exchange and will investigate maximizing the number of additional flow openings.

Table 1-5: Jamaica Bay Barrier Plans from USACE 1976 Study – Openings and Gate Dimensions (USACE-WES, 1976)

Plan	Navigable passage (ungated)	Sill Elevation (MSL)	Aux. Flow Gate	Sill Elevation (MSL)	Number of Aux. Flow Gates	Flow area through barrier (sq. ft)
Plan 3	300 ft	-33 ft	75 ft	-26 ft	12	33,300
Plan 6	110 ft	-33 ft	75 ft	-26 ft	16	34,830

The USACE 2016 report included an evaluation of a number of barrier alignments and barrier alternatives. This document relies in large part on the considerations, data, and findings from USACE 2016. One such finding is the storm surge barrier siting, discussed in the following section. An overview of the gates included within the C1-E alternative from USACE 2016 is presented below in Table 1-6. The conceptual design presented herein will include additional auxiliary flow gates to minimize the impact on flow exchange between the bay and the ocean.

Table 1-6: Preferred Storm Surge Barrier Plan from (USACE, 2016) – Openings and Gate Dimensions

Alternative	Gated Navigable Passage (2 total)	Sill Elevation (NAVD88)	Aux. Flow Gate	Sill Elevation (NAVD88)	Number of Aux. Flow Gates	Flow Area Through Barrier (sq. ft)
C1-E	200 ft	-30 ft	100 ft	-15 ft	7	22,500

For the Hackensack River, there is a USACE Reconnaissance Study from 1989 that addressed the concept of a storm surge barrier. In addition, the Draft Environmental Impact Statement (DEIS) and Feasibility Study for the Rebuild by Design – Meadowlands Project also included an alternative in the early stages that included a storm surge barrier.

These two documents have been used to inform the data presented herein.

- USACE-NAN, 1989, Reconnaissance Report – Hackensack River Basis, New Jersey. (USACE, 1989).
- AECOM, 2018, Sub appendix F1 – Alternative 1 Development and Screening, For the Feasibility Study of Rebuild by Design Meadowlands Flood Protection Project. Report submitted to State of New Jersey Department of Environmental Protection, April 2018. (AECOM, 2018).

2 Basis of Design

2.1 Introduction

This Basis of Design (BOD) establishes criteria to be used throughout the evaluation and design process, including geometric, environmental, equipment, and loading characteristics, along with a bibliography of applicable design codes, standards, and references for the SSBs in the study area, as shown in Figure 2-1.

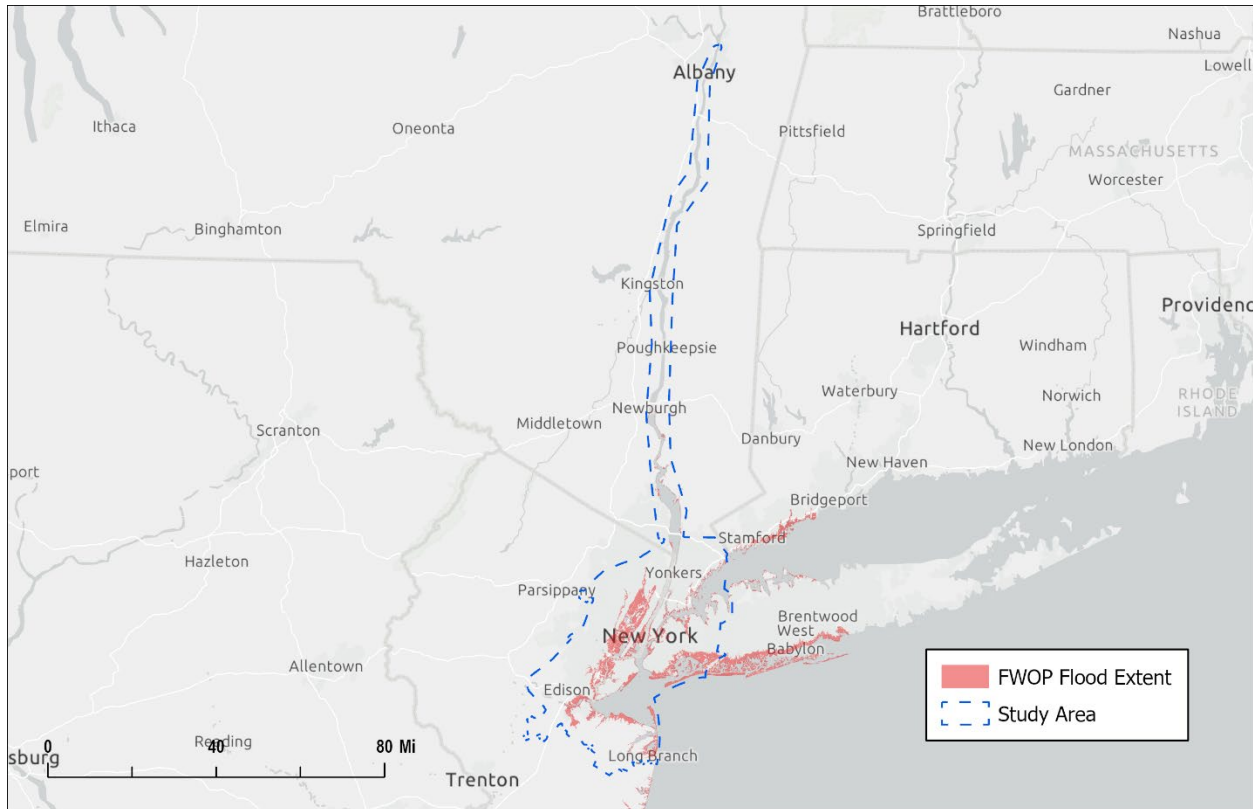

Figure 2-1: NYNJ Harbor & Tributaries Study Area

Initial Storm Surge Barrier concept evaluations were developed for the Verrazzano Narrows, Jamaica Bay, and Hackensack River locations. These evaluations were developed to a sufficient level of detail with the inherent confidence to establish a Class 4 cost estimate; for each of these locations, site-specific environmental, load, geometric, and associated design criteria were used to establish the basic arrangements of barrier structures. Each of the SSB structure locations considered geotechnical data available from nearby structures (e.g., the Verrazzano Narrows SSB considered subsurface profile data from the nearby Verrazzano Narrows Bridge); hence, while site-specific geotechnical explorations were not performed for the barrier locations, there is reasonable confidence that foundation elements are appropriately scaled to anticipated site conditions. Therefore, design criteria used for the evaluation of Verrazzano Narrows, Jamaica Bay, and Hackensack River is considered reasonably informed for the concept designs.

Conversely, site-specific evaluations for the balance of the navigable storm surge barriers (e.g., Arthur Kill, Kill Van Kull) were not performed, and the design criteria for each of those barrier locations is more general in nature. For the alternate barrier locations, adaptations of the more detailed designs were provided, and judgment was used to configure the facilities with layouts and arrangements in sufficient detail to allow for the development of Class 5 estimates. As part of advancing a conceptual design for the storm surge barriers discussed herein, a number of criteria need to be established and defined, quantitatively where possible or qualitatively otherwise. Due to the preliminary nature of this feasibility study, the following criteria should not be seen as comprehensive or complete. Instead, the requirements and criteria form the basis for an iterative design approach of which the feasibility study and conceptual design are the first phase. Important assumptions are highlighted that influence the conceptual designs decisions and, where possible, a discussion is included for issues that need to be addressed as the designs advance.

The listed design criteria are based on qualitative data and desktop analysis to a level of detail commensurate with a feasibility study. In instances where limited data was available, assumptions were made based on engineering judgment, previous experience, and/or the partial data that has been collected over the course of the feasibility study phase. The implications of such assumptions along with recommendations for further data collection and refined analyses to support the design are described at the end of this report.

2.2 Available Data

A review of meteorological and oceanographic conditions at the study sites was performed to provide a basis for the geometry of the structures and the evaluation and selection of the gate types. The following were investigated:

- Authorized channel dimensions
- Storm surge elevations
- Wave climatology
- Local wind conditions
- Discharge regime and tidal prism
- Existing conditions for the study site were developed primarily from available data supplied by USACE and readily available public data. These data included:
 - Tidal data
 - Wind data
 - Geological information to the extent available
 - Coastal Hazard System Data (NACCS storm surge and wave modeling)

2.3 Design References

2.3.1 Codes and Standards

Engineering, analysis, and documentation will be performed in accordance with all applicable guidance, including, where appropriate, the following shown in Table 2-1.

Table 2-1: List of Codes and Standards

Publishing Agency	Document Number	Document Title
ASCE	7-16	Minimum Design Loads and Associated Criteria for Buildings and Other Structures
USACE		Hurricane and Storm Damage Risk Reduction System Design Guidelines (June 2012)
USACE	EC 1110-2-6052	Structural Design of Precast and Prestressed Hydraulic Concrete Structures
USACE	EM 385-1-1	US Army Corps of Engineers Safety and Health Requirements
USACE	EM 1110-2-1100	Coastal Engineering Manual
USACE	EM 1110-2-1613	Hydraulic Design of Deep-Draft Navigation Projects
USACE	EM 1110-2-1614	Design of Coastal Revetments, Seawalls, and Bulkheads
USACE	EM 1110-2-1902	Slope Stability
USACE	EM 1110-1-1904	Settlement Analysis
USACE	EM 1110-1-1905	Bearing Capacity of Soils
USACE	EM 1110-2-1908	Instrumentation of Embankment Dams and Levees
USACE	EM 1110-2-1913	Design and Construction of Levees
USACE	EM 1110-2-2100	Stability Analysis of Concrete Structures
USACE	EM 1110-2-2104	Strength Design for Reinforced Concrete Hydraulic Structures
USACE	EM 1110-2-2502	Retaining and Flood Walls
USACE	EM 1110-2-2504	Design of Sheet Pile Walls
USACE	EM 1110-2-2906	Design of Pile Foundations
USACE	ER 1100-2-8162	Incorporating Sea Level Change in Civil Works Programs
USACE	ETL 1110-2-58	Guidelines for Landscape Planting and Vegetation Management at Levees, Floodwalls, Embankment Dams, and Appurtenant Structures
USACE	ETL 1110-2-584 ⁽¹⁾	Design of Hydraulic Steel Structures
USACE	NANP-1110-1-1	New York District Design Submission Requirements Manual
OSHA		Occupational Safety and Health Administration (OSHA) standards
PIANC	Working Group 121	Harbour Approach Channels Design Guidelines

Note:

1. This letter supersedes EM 1110-2-2105, EM 1110-2-2701, EM 1110-2-2703, and 1110-2- 2705.

2.3.2 Prior Reports and Studies

See section 1.4.

2.4 System of Units and Reference Datum

U.S. customary units shall be used.

The vertical datum for the project shall be NAVD88, Geoid 12B. All elevations throughout the report are referenced to NAVD88 Geoid12B unless otherwise stated. The horizontal datum shall be the North American Datum of 1983 (NAD83) State Plane.

2.5 Service Life

The storm surge barriers have various project components for which Life Cycle Design should be considered (ER 1110-2-8159). At this stage of the project (feasibility study), no such analysis has been performed. A minimum project service life of 100 years is preliminarily recommended as a result of the size and nature of the project. For certain project elements, a shorter service life may be feasible.

For the storm surge barrier to meet the functional requirements regarding flood risk reduction (see Section 2.6), a period of analysis has been established that is shorter than the recommended project service life. The project will perform to meet the design criteria related to flood risk reduction in this document for a 50-year period spanning the years between 2045 and 2095. The project is to be designed for sea level rise (NRC Curve I intermediate scenario), regional subsidence, and local settlement occurring for a 50-year planning horizon (to the year 2095). After such a time, to achieve the same level of risk reduction, the structures may have to be modified or improved (i.e., adaptive management may be necessary or structural improvements may be needed if the observed sea level rise exceeds the planning criteria). Design provisions will be required to accommodate such improvements as needed.

2.6 Functional Requirements

2.6.1 Basic Requirements

The following basic functional requirements have been identified for the conceptual design of the storm surge barrier, consistent with the overall objectives of the NYNJHAT Study:

- The storm surge barrier will provide a reliable structural measure as part of the NYNJHAT Study Alternatives to reduce the risk of coastal storm damage to coastal region behind it;
- The storm surge barrier will minimize impact to navigation and waterborne commerce;
- The storm surge barriers will minimize impact on the water exchange through the opening during normal operation (non-storm conditions) in order to minimize impacts on the inner basin environmental conditions; and,
- The storm surge barrier will minimize the impact on upstream water levels during operation.

As a result of the above requirements, the storm surge barrier concept will, at its simplest, consist of two principal parts: 1) moveable gates (both navigable gates and flow control gates) with

associated gate support structures, and 2) tie-in structures. For any system of movable gates, including navigable gates and flow control gates, there are three basic functional requirements:

- The moveable gates of the storm surge barrier will be able to open and close with a high degree of reliability;
- The gates will be sized and provide a range of motion suitable for purpose (e.g., navigation, flow conveyance); and
- The moveable gates and gate structures will be an integral part of the overall storm surge barrier structure and be designed such that they impede the coastal storm flood levels and minimize the risk of coastal storm damage to the region behind it.

For the purpose of the feasibility design, the flow control portion (i.e., the non-navigable lift gates) of the storm surge barrier will size the piers and towers at VN, JB, and HR stoutly enough to handle single-leaf lift gates and assume relatively simple mechanical systems and somewhat quicker gate closure times. There are at least three options for the lift gates depending on height, location, complexity of mechanical and electrical equipment, and time to deploy: single-leaf with vertical storage, single-leaf with horizontal storage, and multi-panel with vertical storage. Consideration for alternatives to single-leaf lift gates may be prudent in subsequent project phases.

2.6.2 Operations and Maintenance

2.6.2.1 Closure and Opening Criteria

When studying the feasibility of an SSB to reduce the flood risk for an area in lieu of a perimeter-type flood risk reduction system, one must consider the operation of the structure such that it functions per the intended purpose during its service life. Flood risk is an issue for the NYNJHAT Study Area during present day and with sea level expected to increase over time. As a result, it is necessary to assess the performance of the SSB and its conceptual options plan over time. This then aids in understanding the impacts resulting from the SSB gate operation (closure and opening) and the potential need to adjust operations over time.

As introduced in Section 1.2, the six larger storm surge barriers are expected to be constrained in relation to their operations (SCO), while the remaining 12 storm surge barriers are assumed to be only moderately constrained in terms of closure and opening criteria (MCO). Operations can be simplified using two key parameters: closure criterion and closure elevation. The closure criterion is the forecasted water level for which operation of a storm surge barrier is authorized to reduce flood risk for the region behind it. This should not be confused with the closure elevation. The closure elevation is the observed water level at which the mechanical closure procedure is executed. The closure elevation is lower than the closure criterion to safely maintain water levels below the threshold criterion within the basin.

For example, if the forecasted water level exceeds the closure criterion, the SSB closure is authorized. The closure of the SSB gates occurs when the water level reaches the closure elevation. Gate opening occurs once the peak(s) of the storm surge has passed and water levels on the flood side of the SSB are falling and are equal to, or just below, the water levels within the basin. A

more detailed description of the typical sequence of events during a storm surge barrier closure, a storm event passing, and storm surge barrier opening are included in Annex E.

For all storm surge barriers under the NYNJHAT Study, a preliminary closure criterion of +7 feet NAVD88 has been set (Table 2-2). For present day conditions, the +7 feet NAVD88 corresponds to approximately a 10-year average recurrence interval at the southern tip of Manhattan Island (The Battery, NY). This closure criterion is preliminary; ultimately the closure of any specific SSB location (or set of storm surge barriers if the structures enclose the same basin) would be refined. A refinement of the closure criterion should consider the costs of enacting the closure and the benefits of flood risk reduction for the area upstream. The costs of closure are navigational (specific to the location) and environmental (specific to the basin for which the SSB provides flood risk reduction). It is, however, assumed that the SSB labeled as MCO would have fewer adjustments to the closure criterion over time as sea level rises and the AEP of an SSB closure could eventually be as high as 50% – while for the SCO, SSBs infrequent operation is assumed, justifying the need for RRFs within the basins and an AEP of closure of approximately 10%.

A more detailed discussion and evaluation of closure criteria, closure duration, and closure probability are provided in Annex D. The main findings are provided in the table below.

Table 2-2: Storm Surge Barriers Closure Criterion

Name of Storm Surge Barrier	Abbr.	Alt. 2	Alt. 3A	Alt. 3B	Alt. 4	Alt. 5	Strict Constrained Operation (SCO) or Moderately Constrained Operation (MCO)	Prelim. Closure Criterion (ft NAVD88)
Storm Surge Barriers								
Outer Harbor	OH	YES					SCO	+7
Throgs Neck	TN	YES	YES				SCO	+7
Verrazzano Narrows	VN		YES				SCO	+7
Arthur Kill	AK		YES	YES			SCO	+7
Jamaica Bay	JB		YES	YES	YES		SCO	+7
Kill Van Kull	KVK			YES			SCO	+7
Hackensack River	HR				YES		MCO	+7
Newtown Creek	NC			YES	YES		MCO	+7
Gowanus Canal	GC			YES	YES		MCO	+7
Flushing Creek	FC			YES	YES		MCO	+7
Sheepshead Bay	SB		YES	YES	YES		MCO	+7
Gerritsen Creek	GRC		YES	YES	YES		MCO	+7
Induced Flooding Mitigation Features								
Eastchester Creek	EC	YES	YES				MCO	+7

Name of Storm Surge Barrier	Abbr.	Alt. 2	Alt. 3A	Alt. 3B	Alt. 4	Alt. 5	Strict Constrained Operation (SCO) or Moderately Constrained Operation (MCO)	Prelim. Closure Criterion (ft NAVD88)
Port Washington	PW	YES	YES				MCO	+7
Hempstead Harbor	HH	YES	YES				MCO	+7
Hammond Creek	HC	YES	YES				MCO	+7
Highlands	HL		YES				MCO	+7
Raritan River	RR		YES				MCO	+7

2.6.2.2 Vehicular Access

One-way traffic access for maintenance and flood fighting is required for all barriers in the form of a 12.5-foot-wide roadway. At locations where the roadway is discontinuous (e.g., at the VN abutments), enough room for three-point turns shall be provided. Ramps with no more than a 6% grade are anticipated wherever the roadway needs to change elevation.

A Class 5, 20,000-pound GVW crew cab vehicle is anticipated to transit the lift gates, the conventional sector gates, and dam sections. Additionally, a Class 6, 30,000-pound GVW truck equipped with an under-bridge inspection unit is expected to be used for inspection and maintenance duties.

Design for larger maintenance vehicles or construction equipment shall be addressed where justified by the construction or maintenance requirements. At this time, no additional requirements are established.

2.6.3 Constructability & Existing Subaqueous Utilities

2.6.3.1 Existing Subaqueous Utilities

Verrazzano Narrows SSB

The Verrazzano Narrows SSB will be situated south of Homeport Pier and north of the Verrazzano Narrows Bridge, bisecting the USCG Stapleton anchorage area. There are existing oil, gas, and electric lines crossing the Narrows in that vicinity. The selected VN SSB alignment for the feasibility design places the barrier just north of six electric cables. In addition to the utilities, there are two existing water siphons within near proximity to the proposed SSB alignment. See Figure 2-2 below.

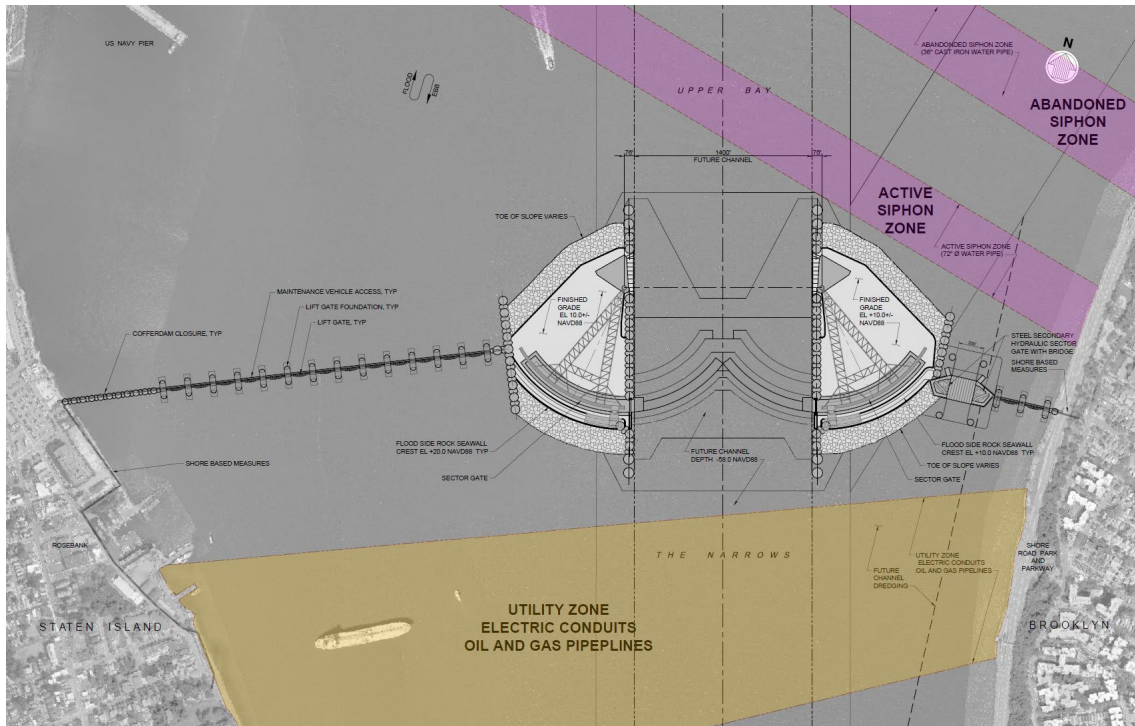

Figure 2-2: Verrazzano Narrows SSB Plan and Known Utility Zones Highlighted

Jamaica Bay SSB

For the feasibility-level design, it is assumed that there are no existing utilities that interfere with the proposed alignment of the SSB for Jamaica Bay. Known utility crossings are located further to the west in the vicinity of the Gil Hodges Bridge.

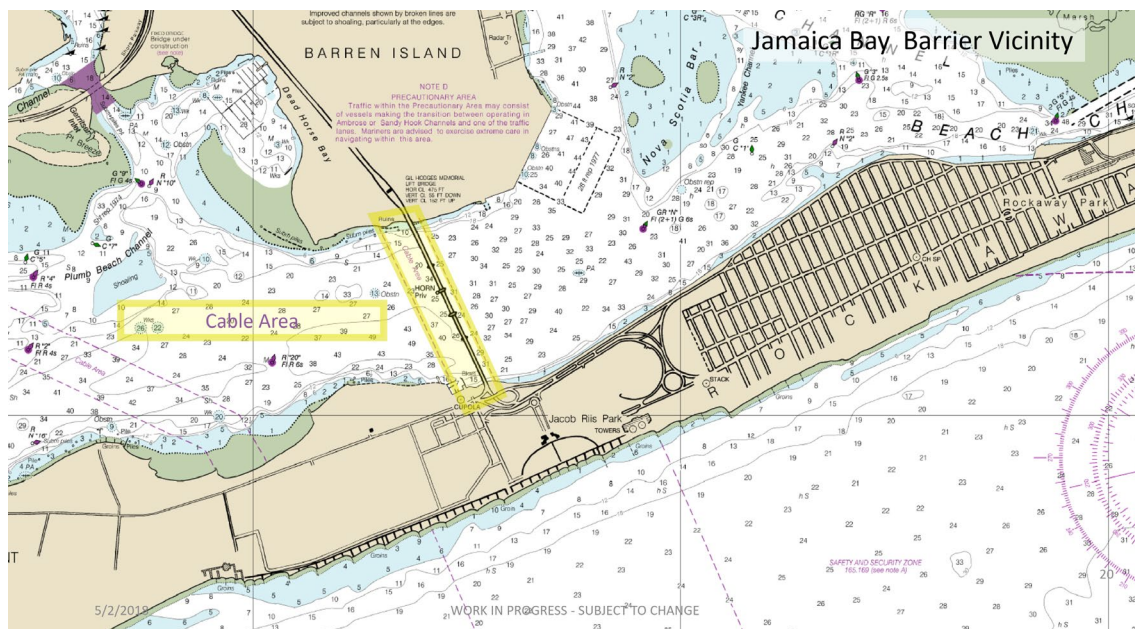

Figure 2-3: Jamaica Bay SSB Plan and Known Utility Zones Highlighted

Hackensack River SSB

For the feasibility level of design, it is assumed that the Hackensack River SSB will not interfere with existing utilities. The design team has no indication of utilities crossing the river near the SSB.

2.7 Hydraulic/Coastal BOD

2.7.1 Bathymetry and Topography

Bathymetric data was obtained from the NOAA DEM as well as from USACE-NAN channel survey conditions. The bathymetric data was used to generate channel cross-section profiles and assess existing flow areas and flow area restrictions as a result of the conceptual design and geometry of the storm surge barrier openings. Bathymetric maps and cross-sectional bathymetric profiles are presented in the conceptual design summary sections for each storm surge barrier.

2.7.2 Navigation

The proposed storm surge barriers (see Table 2-3) discussed in this report cross federally authorized navigation channels. Channel dimensions are derived from the following resources.

- Controlling Depth Reports and Surveys (1)
- Project Maps, Rivers & Harbors, Navigation Projects (2)
- Nautical Charts (3)

The Verrazzano Narrows, between Staten Island and Brooklyn, is the principal entrance to the New York–New Jersey Harbor and is one of the busiest waterways in the United States. The proposed storm surge barrier at the Verrazzano Narrows would intersect with Ambrose Channel Federal Navigation Channel. The proposed Outer Harbor storm surge barrier would intersect with three federal navigation channels, including Ambrose, Sandy Hook, and Rockaway Inlet. The authorized channel dimensions for all federal channels that intersect with the proposed storm surge barrier locations are provided in Table 2-3. For those locations where a varying authorized width is documented, the approximate width at the proposed storm surge barrier location is provided in the last column.

For the Hackensack River, it should be noted that the constructed portion of the federally authorized navigation channel terminates at the end of the Marion Reach and Turning Basin (Reach C); this is located downriver of the Newark-Jersey Turnpike Bridge and downriver of the proposed storm surge barrier. Reach D of the federal channel continues upstream at a width of 200 feet and an authorized depth of 15 feet below mean lower low water (MLLW). The authorized depth of Reach D at 15 feet was never constructed; however, it is used as a design criterion.

A federal navigation channel exists at all draft storm surge barriers discussed herein, except for Gerritsen Creek, Port Washington, and Hammond Creek, and the dimensions are summarized in Table 2-3 below. Additionally, it is noted that no deepening of the federal channels is assumed to

occur within the study area during the project service life. This assumption is based on the plan formulation and the description of the Future Without Project (FWOP) conditions of the NYNJHAT Study.

Table 2-3: Federal Navigation Channel Intersecting with the Proposed Storm Surge Barriers

Storm Surge Barrier Location	Name of Channel	Reach of Federal Channel	Authorized Project Width (ft)	Authorized Project Length ² (nm)	Authorized Project Depth (ft-MLLW)
Verrazzano Narrows	Ambrose Channel	Reach D	2,000	2.9	53
Throgs Neck	East River	Reach K	175 to 1,040 ³	1.45	35
Arthur Kill	Arthur Kill	Outerbridge Reach	600 to 840 ⁴	1.60	35
Outer Harbor	Ambrose Channel	Reach B	2,000	4.2	53
	Sandy Hook Bayside Reach	Partial Reach B-Bayside Reach	800	2.4	35
	Rockaway Inlet	Jamaica Bay Reach A	1,000	1.5	20
Kill Van Kull	Kill Van Kull Channel	Constable Hook Reach	2,000 to 800 ⁵	2.52	50
Jamaica Bay	Jamaica Bay Federal Navigation Channel	Reach B	1,000 to 500 ⁶	0.71	18
Hackensack River	Newark Bay, Hackensack & Passaic Rivers; Hackensack River, New Jersey	Partial Reach D-Route #3 Highway	200	N/A	15
East Chester Creek	East Chester Creek	Reach A	200	N/A	8
Flushing Creek	Flushing Bay and Creek	Reach B	135	N/A	15
Newtown Creek	Newton Creek	Reach A	130	N/A	23
Sheepshead Bay	Sheepshead Bay	Sheepshead Bay	100	N/A	6
Port Washington ¹	NA	N/A	N/A	N/A	N/A
Hempstead Harbor	Glen Cove	Reach A	100-50	N/A	8
Hammond Creek ¹	NA	N/A	N/A	N/A	N/A
Gowanus Canal	Gowanus Canal	Reach B	100	N/A	18
Gerritsen Creek ¹	NA	N/A	N/A	N/A	N/A
Highlands	Shrewsbury River	Reach A	300 to 415	N/A	15

Storm Surge Barrier Location	Name of Channel	Reach of Federal Channel	Authorized Project Width (ft)	Authorized Project Length² (nm)	Authorized Project Depth (ft-MLLW)
Raritan River	Raritan River	Reach B	300 to 380	N/A	28

Note:

¹ Not a federal channel.

² Length of the federal reach is only provided for the larger storm surge barriers

³ At the proposed location the authorized width is approximately 1000 ft

⁴ At the proposed location the authorized width is approximately 600 ft

⁵ At the proposed location the authorized width is approximately 800 ft

⁶ At the proposed location the authorized width is approximately 500 ft

⁷ Channel depth is referenced to MLLW (Mean Lower Low Water) Datum

2.7.2.1 Navigation Criteria

2.7.2.1.1 Navigation Safety

The proposed storm surge barriers will cross one or more federal navigation channels, and cross-currents or excessive head-on and helping currents at the navigable passage could adversely impact navigation. The storm surge barrier and gate layout should be optimized to minimize adverse influence on vessels transiting the storm surge barrier. Additionally, the provision of vessel guides, aids-to-navigation, and protective structures at the navigable channel entrance and exits will be considered to increase navigational safety and potentially protect the storm surge barrier from aberrant vessel impact.

2.7.2.2 Design Vessels

The design of each navigable passage within the storm surge barriers must accommodate the volume of vessel traffic transiting the respective navigation channels. To do so, an understanding of the range of vessel types and configurations that comprise the marine traffic and the frequency of their passage through these channels was established through the analysis of AIS data. The Maritime Traffic Analysis (Annex A) presents vessel categories that capture the range of vessels that transit the channels. A summary of the findings documented in Annex A is provided in Table 2-4 below.

The Verrazzano Narrows, Kill Van Kull, and the Outer Harbor–Ambrose Channel navigable passage list the same design vessel as all these storm surge barriers cross the channels that lead to and from the Container Terminals in Newark Bay. The American Princess (Passenger Vessel) is selected as design vessel for the approach into and out of Jamaica Bay.

Table 2-4: Design Vessels for the Navigable Passages

Location	Design Vessel	Vessel Category	LOA	Beam	Draft	Air Draft
Verrazzano Narrows	OOCL Hong Kong	Container (21.4k TEU)	400m 1,310ft	58.8m 193ft	16.8m 55ft	Not Available
Throgs Neck	Asphalt Splendor	Tanker	179.9m 590ft	30.6m 100ft	7.9m 26.2ft	Not Available
Arthur Kill	Australian Spirit	Tanker	256m 840ft	44.8m 147ft	14.1m 46ft1	Not Available
Outer Harbor (Sandy Hook Channel)	Cape Bonney	Tanker	274.5m 901ft	48m 158ft	10.7m 35ft	Not Available
Outer Harbor (Ambrose Channel)	OOCL Hong Kong	Container (21.4k TEU)	400m 1,310ft	58.8m 193ft	16.8m 55ft	Not Available
Outer Harbor (Rockaway Inlet)	American Princess	Passenger Ship	45m 148ft	11m 35ft	N/A	Not Available
Kill Van Kull	OOCL Hong Kong	Container (21.4k TEU)	400m 1,310ft	58.8m 193ft	16.8m 55ft	Not Available
Jamaica Bay	American Princess	Passenger Ship	45m 148ft	11m 35ft	N/A	Not Available

2.7.3 Hydrological Characteristics

The characteristics of the hydrodynamic circulation of the New York Harbor area, Newark, Hudson River, East River, and Throgs Neck’s connection to the Long Island Sound are well documented in previous studies. Aerts et al. provides a brief but clear description of the hydrological characteristics of the area of interest (Aerts, De Moel, & Botzen, 2013). The description is provided hereafter but is shortened for brevity with parameters converted to U.S. customary units.

Numerous descriptive and modeling studies have described the hydrology and hydrodynamic circulation of the Hudson Estuary, the NY Harbor area, and the NY Bight (for an overview, see Blumberg, Khan and St. John 1999). The New York Harbor is located at the mouth of the Hudson River, which discharges to the ocean via New York Bay and the Verrazzano Narrows. This area is bordered by Brooklyn to the east and Staten Island to the west. The second connection of the Hudson River/New York Bay to the Atlantic Ocean is via the East River and Long Island Sound. Long Island Sound is an estuary of about 100 miles with a mean depth of 65 feet.

The highest freshwater inflow to the NY Bay area is provided by the Hudson River. The river has a length of 315 miles that originates at “Lake Tear of the Clouds” in the Adirondack Mountains and drains a watershed of about 14,000 square miles. The long-term annual mean discharge is about 21,900 cfs, with a peak discharge in April (mean monthly flow ~42,400 cfs). Minimum flows occur in August (discharge ~6,700 cfs). The Hudson River has an average depth of 30-50 feet (Geyer and Chant, 2006), and is influenced by the ocean tide, which can propagate upstream about 180 miles. Other freshwater sources are from water treatment plants and

stormwater runoff. (Rozenzweig, et al., 2007). Blumberg et al. estimated a runoff of 4,025 cfs, from 110 wastewater treatment plants in their hydrodynamic modeling framework (Blumberg, Khan, & St John, 1999). Additional runoff can be produced by rainfall and storm water discharges.

The harbor receives a significant sediment load from the Hudson River with an average of 1 million tons per year (HydroQual, 2007). Siltation problems occur in the lower Hudson estuary where the river widens as it empties into New York Harbor and the Lower New York Bay. Furthermore, on the southern coast of Long Island, a westward migration of sand and a northward migration along the New Jersey coast contribute further sedimentation problems to the NY Bay area, which requires periodic dredging to maintain the depth of navigation channels.

The following hydrologic description of the Hackensack River is based on the report titled Hackensack River Basin, New Jersey – Reconnaissance Report (USACE, 1989).

The Hackensack River Basin is situated in the northeasterly part of the State of New Jersey and the most southerly section of New York State, west of the Hudson River. The Hackensack River and its tributaries are located primarily in Bergen County, NJ, with portions in Hudson County, NJ, and Rockland County, NY. Tidal flooding occurs along the Hackensack River and its tidal tributaries, specifically in the Hackensack Meadowlands located in Bergen County, NJ. The Hackensack River Basin drains 197 square miles. The river originates in the northern Palisades in Rockland County, NY, and runs 50 miles to its mouth in Newark Bay. The river is tidal and navigable from the mouth for 21.5 miles upstream; at this point there is a tidal barrier.

The Hackensack River estuary is of the coastal plain type, formed when rising ocean levels inundated a former glacial lakebed and the river that fed it. The depth is shallow when compared to the width, and the river depth increases gradually going downstream towards Newark Bay. The Hackensack River is well mixed vertically and laterally but has a horizontal salinity gradient from its mouth to the upstream areas. The ratio of tidal prism to freshwater inflow is high. The river is tidal as far upstream as river mile 21.5.

The same report also provides a peak discharge vs. frequency curve for USGS gaging station #01378500: Hackensack River at New Milford, NJ. This station is approximately 15 miles upstream, yet the discharge in the Hackensack River is largely correlated to water release from the Oradell reservoir: 10%, 2% and 1% AEP river discharges correspond to 3,800 cfs, 5,800 cfs, and 6,870 cfs, respectively.

The Passaic River formed as a result of drainage from a massive proglacial lake that formed in Northern New Jersey at the end of the last ice age, approximately 13,000 years ago. The Passaic River is approximately 80 miles long and located in northern New Jersey. The river, in the upper course flows in a highly circuitous route, meandering through the swamp lowlands between the ridge hills of rural and suburban northern New Jersey. In the lower portion, it flows through the most urbanized and industrialized areas of the state, including along downtown Newark. Annual exceedance probabilities of river flows have been determined using USGS StreamStats tool (USGS, 2018); 10%, 2%, and 1% AEP peak flow river discharges correspond to 19,100 cfs, 27,400 cfs, and 31,500 cfs, respectively.

2.7.4 Design Water Densities

Due to the relatively large area under consideration, the water density and salinity content will vary at specific SSB locations. Table 2-5 provides assumed water densities for conceptual design purposes of three storm surge barriers: Verrazzano Narrows, Jamaica Bay, and Hackensack River. Two densities are provided in the table, one for when determining lateral and uplift design pressures and loads, and one for when relying on buoyant force for calculating draft of float-over modular construction techniques.

Table 2-5: Water Density for Design

Location	Water Density for Uplift and Lateral Pressures pounds per cubic feet (pcf)	Water Density when Considering Float-out and Buoyancy (pcf)
Verrazzano Narrows	64	64
Jamaica Bay	64	64
Hackensack River	63	62.4

2.7.5 Astronomical Tides

Information on tidal water levels is obtained from NOAA’s Center for Operational Oceanographic Products and Services (CO-OPS) website (NOAA). Tidal data for each location are derived from the NOAA gauges provided in Table 2-6 and used for the conceptual design.

Table 2-6: Storm Surge Barrier Locations and Tidal Gauges

Tide Gauge	Station Number	Storm Surge Barrier (Abbr.)
The Battery	8518750	VN, NC, GC
Kings Point	8516945	TN, FC, EC, PW, HH, HC
Sandy Hook	8531680	AK, OH, SHB, GRC, HL
Bergen Reach West	8519483	KVK
Sandy Hook	8531680	JB
Amtrak RR Swingbridge, Hackensack River, NJ	8530696	HR

Tidal datums for each of the storm surge barriers are provided in Table 2-7 through Table 2-11.

Table 2-7: Tidal Datums for Station 8518750, The Battery, NY

Tidal Datum	Abbreviation	NAVD88 (ft)	MLLW (ft)
Highest Observed 10/30/2012	Max Tide	11.27 (failed)	14.04 (failed)
Highest Astronomical Tide 10/16/1993	HAT	3.58	6.35
Mean Higher-High Water	MHHW	2.28	5.05
Mean High Water	MHW	1.96	4.73
Mean Sea Level	MSL	-0.2	2.57

Tidal Datum	Abbreviation	NAVD88 (ft)	MLLW (ft)
Mean Low Water	MLW	-2.57	0.2
Mean Lower-Low Water	MLLW	-2.77	0
Lowest Astronomical Tide 1/21/1996	LAT	-4.13	-1.39
Lowest Observed 2/2/1976	Min Tide	-7.06	-4.29
Mean Tidal Range	MN	4.53	4.53

Table 2-8: Tidal Datums for Station 8531680, Sandy Hook, NJ

Tidal Datum	Abbreviation	NAVD88 (ft)	MLLW (ft)
Highest Observed 10/29/2012	Max Tide	9.21 (failed)	12.03 (failed)
Highest Astronomical Tide	HAT	3.78	6.60
Mean Higher-High Water	MHHW	2.41	5.23
Mean High Water	MHW	2.08	4.90
Mean Sea Level	MSL	-0.24	2.58
Mean Low Water	MLW	-2.62	0.20
Mean Lower-Low Water	MLLW	-2.82	0
Lowest Astronomical Tide	LAT	-4.19	-1.37
Lowest Observed 2/2/1976	Min Tide	-7.53	-4.71
Mean Tidal Range	MN	4.70	4.70

Table 2-9: Tidal Datums for Station 8516945, Kings Point, NY

Tidal Datum	Abbreviation	NAVD88 (ft)	MLLW (ft)
Tidal Datum	Abbreviation	NAVD88 (ft)	MLLW (ft)
Highest Observed 10/30/2012	Max Tide	10.09 (failed)	14.25 (failed)
Highest Astronomical Tide 10/16/1993	HAT	5.5	9.66
Mean Higher-High Water	MHHW	3.64	7.80
Mean High Water	MHW	3.28	7.44
Mean Sea Level	MSL	-0.27	3.89
Mean Low Water	MLW	-3.88	0.28
Mean Lower-Low Water	MLLW	-4.16	0
Lowest Astronomical Tide 1/21/1996	LAT	-5.77	-1.61
Lowest Observed 2/2/1976	Min Tide	-8.17	-4.01
Mean Tidal Range	MN	7.16	7.16

Table 2-10: Tidal Datums for Station 8519483, Bergen Reach West, NY

Tidal Datum	Abbreviation	NAVD88 (ft)	MLLW (ft)
Tidal Datum	Abbreviation	NAVD88 (ft)	MLLW (ft)
Highest Observed 10/30/2012	Max Tide	11.69	14.57
Highest Astronomical Tide 10/14/1995	HAT	4.07	6.95
Mean Higher-High Water	MHHW	2.63	5.51
Mean High Water	MHW	2.31	5.19
Mean Sea Level	MSL	-0.18	2.7
Mean Low Water	MLW	-2.67	0.21
Mean Lower-Low Water	MLLW	-2.88	0
Lowest Astronomical Tide 2/08/1997	LAT	-4.51	-1.63
Lowest Observed 2/9/1985	Min Tide	-6.36	-3.48
Mean Tidal Range	MN	4.98	4.98

**used NACCS save points to convert MSL to NAVD*

Table 2-11: Tidal Datums for Station 8530696, Amtrak RR Swing Bridge, Hackensack River, NJ

Tidal Datum	Abbreviation	NAVD88 (ft)	MLLW (ft)
Tidal Datum	Abbreviation	NAVD88 (ft)	MLLW (ft)
Highest Observed	Max Tide	N/A	N/A
Highest Astronomical Tide	HAT	N/A	N/A
Mean Higher-High Water	MHHW	2.97	5.79
Mean High Water	MHW	2.68	5.5
Mean Sea Level	MSL	0.22	3.04
Mean Low Water	MLW	-2.59	0.23
Mean Lower-Low Water	MLLW	-2.82	0
Lowest Astronomical Tide	LAT	N/A	N/A
Lowest Observed	Min Tide	N/A	N/A
Mean Tidal Range	MN	5.79	5.79

2.7.6 Relative Sea Level Change

Relative sea level change (RSLC) values are based on the USACE moderate scenario (ER 1100-2-8162) for three tidal gauge stations: Sandy Hook, The Battery, and Kings Point. These values are provided in Table 2-12.

Table 2-12: Relative Sea Level Change per USACE’s Intermediate Scenario in Feet (ft)

Year	Station 8561680 Sandy Hook	Station 8518750 The Battery	Station 8516945 Kings Point
1992 (base year)	0	0	0
2045	0.94	0.76	0.66
2095	2.29	1.93	1.74
2105 ¹	2.61	2.22	2.01

Notes

1 Storm Surge Barriers were originally designed for the year 2105 based on the earlier established period of economic analysis.

Sea level change values from the station nearest to the proposed storm surge barriers will be applied to obtain design water levels for both operational and extreme conditions. The Sandy Hook Station data will be utilized for the Outer Harbor, Arthur Kill, Verrazzano Narrows, and Jamaica Bay storm surge barrier. The Battery station data will be utilized for the Kill Van Kull and Hackensack River storm surge barrier and the Kings Point station data will be utilized for the Throgs Neck storm surge barrier.

2.7.7 Tidal Flows and Current Magnitudes

Tidal flow characteristics are obtained from modeling work performed by ERDC (USACE ERDC, 2019). USACE-ERDC analyzed the NYNJHAT Study alternatives and the impacts on normal tidal conditions and circulation. This modeling effort focused mainly on the impacts of the larger storm surge barriers discussed herein (the three reference storm surge barriers VN, JB, HR and AK, KVK, and OH). Tidal flow analyses for the remainder of the (smaller) storm surge barriers will be completed in a later phase. A data summary is provided here and is based on the statistical analysis of model output for the 1995 calendar year for a cross-section spanning the storm surge barrier sites. The values presented in Table 2-13 show tidal fluxes and are model results rounded to the nearest thousand cfs and averaged between ebb and flood flows for base conditions, i.e., without the storm surge barriers in place.

Table 2-13: Tidal Fluxes

Location	Mean Tidal Flow (m ³ /s)	Mean Tidal Flow (cfs)	Maximum Tidal Flow (m ³ /s)	Maximum Tidal Flow (cfs)
Verrazzano Narrows	16,100	568,000	36,400	1,286,000
Throgs Neck	5,800	204,000	13,000	459,000
Arthur Kill	1,200	43,000	3,200	113,000
Outer Harbor	39,400	1,391,000	115,900	4,092,000
Kill Van Kull	2,400	83,000	7,700	274,000
Jamaica Bay	3,700	129,000	10,300	363,000
Hackensack River	900	32,000	2,500	87,000

The values presented in Table 2-14 show tidal surface currents at predetermined output locations and are model results averaged between ebb and flood flows for base conditions, i.e., without the storm surge barriers in place. Values are also provided in knots for ease of reference and in support of interpretation by the navigation community and marine engineering discipline.

Table 2-14: Tidal Currents

Location	Output Point	Mean Tidal Current Magnitude (knts)	Mean Tidal Current Magnitude (ft/s)	Maximum Tidal Current Magnitude (knts)	Maximum Tidal Current Magnitude (ft/s)
Verrazzano Narrows	S2	1.3	2.2	2.7	4.6
Throgs Neck	V4	1.0	1.8	2.6	4.4
Arthur Kill	S1	0.7	1.2	1.5	2.5
Outer Harbor (Sandy Hook Channel)	V1	1.5	2.6	3.6	6.0
Outer Harbor (Ambrose Channel)	V2	1.2	2.0	2.8	4.8
Outer Harbor (Rockaway Inlet)	V3	1.0	1.8	2.5	4.2
Kill Van Kull	T1	0.7	1.2	2.2	3.6
Jamaica Bay	S3	0.8	1.3	1.9	3.2
Hackensack River	R1	0.9	1.5	2.1	3.6

2.7.8 Extreme Water Levels

Table 2-15 provides an overview of the extreme water levels at the storm surge barrier location. The utilized Advanced Circulation Model (ADCIRC) nodes/output stations per storm surge barrier location are listed in the second column.

Table 2-15: AEP Still Water Levels (50% confidence limit) from NACCS ADCIRC output, inclusive of Sea Level Rise in 2045 and 2095. Specific output nodes referenced in table.

SSB	NACCS ID	RP (ft NAVD88)	1992 (ft NAVD88)	2045 (ft NAVD88)	2095 (ft NAVD88)
VN	11781	100	12.4	13.4	14.3
		500	16.5	17.5	18.4
		1,000	18.4	19.3	20.3
TN	4347	100	13.4	14.2	15.3
		500	16.9	17.7	18.8
		1,000	18.6	19.5	20.5
AK	11650	100	13.9	15.0	15.8
		500	18.2	19.3	20.1
		1,000	20.1	21.3	22.0
OH	3900	100	11.4	12.6	13.3
		500	15.1	16.2	17.0
		1,000	16.7	17.9	18.6
KVK	11766	100	11.9	12.9	13.8
		500	15.8	16.7	17.7
		1,000	17.5	18.5	19.4
JB	3592	100	11.9	13.1	13.8
		500	15.4	16.5	17.3
		1,000	16.9	18.0	18.8
HR	11816	100	14.4	15.3	16.3
		500	17.5	18.4	19.4
		1,000	18.7	19.7	20.6
NC	13898	100	11.8	12.7	13.7
		500	15.6	16.5	17.5
		1,000	17.3	18.3	19.2

2.7.9 Extreme Wave Heights and Period

Table 2-16 shows the wave height and period from that of a 100-year, 500-year and 1,000-year storm. The ADCIRC nodes/output stations per storm surge barrier location are listed in the second column.

Table 2-16: AEP Wave Characteristics (50% Confidence Limit)

SSB	NACCS ID	RP years	Hs (ft) mean	Tp (sec) mean
VN	11781	100	5.9	6.0
		500	6.9	6.5
		1,000	7.3	6.8
TN	4347	100	4.3	5.6
		500	4.5	5.8
		1,000	4.6	5.9
AK	11650	100	3.8	5.4
		500	4.4	5.8
		1,000	4.6	5.9
OH	3900	100	16.1	14.1
		500	16.8	14.5
		1,000	17.1	14.6
KVK	11766	100	6.0	6.2
		500	6.2	6.3
		1,000	6.3	6.3
JB	3592	100	4.8	5.7
		500	5.1	5.8
		1,000	5.2	5.9
HR	11816	100	3.2	5.3
		500	3.6	5.6
		1,000	3.7	5.7
NC	13898	100	3.7	5.4
		500	4.1	5.7
		1,000	4.3	5.8

2.7.10 Wave Overtopping Criteria

For the storm surge barriers in the NYNJHAT Study, an overtopping criterion of 200 liter per second per meter (l/s/m) is set to determine the structure height. This equates to 2.15 cfs/ft and is based on ER 1110-2-1100 (USACE, 2002) and guidance from USACE-NAN. This criterion is applied at the end of the project service life.

2.7.11 Design Crest Elevation

The storm surge barriers are conceptually designed to meet the functional criteria (impede storm surge) over the entire planning horizon (2045–2095). Based on the provided 1% AEP hydrodynamic characteristics for the year 2095 (extreme water levels and waves) and given the provided overtopping criterion, the SSB design crest elevations have been determined from an

overtopping analysis. Crest elevations are summarized in Table 2-17. For further information about the overtopping analysis and crest elevations, the reader is referred to Annex B.

Table 2-17: Crest Elevations of Storm Surge Barriers

Storm Surge Barrier	Crest Elevation (ft NAVD88)	AEP Condition	Still Water Level ¹ (ft NAVD88)	50% CL Overtopping Rate (l/s/m)	90% CL Overtopping Rate (l/s/m)
Verrazzano Narrows	+19	1%	14.6	46.1	150.4
Throgs Neck	+19	1%	15.4	22.3	113.8
Arthur Kill	+19	1%	16.5	30.9	169.4
Outer Harbor	+29	1%	14.0	102.4	174.3
Kill Van Kull	+19	1%	14.2	40.6	127.4
Jamaica Bay	+18	1%	14.5	35.9	138.7
Hackensack River	+19	1%	16.6	19.3	171.6
Flushing Creek	+18	1%	15.3	15.0	117.7
Newtown Creek	+17	1%	14.0	19.0	111.8
Gowanus Canal	+16	1%	13.7	31.7	186.2
Sheepshead Bay	+17	1%	13.7	53.6	190.1
Gerritsen Creek	+17	1%	13.9	23.7	126.8
Eastchester Creek	+19	1%	N/A	N/A	N/A
Port Washington	+19	1%	N/A	N/A	N/A
Hempstead Harbor	+19	1%	N/A	N/A	N/A
Hammond Creek	+19	1%	N/A	N/A	N/A
Highlands	+18	1%	N/A	N/A	N/A
Raritan River	+19	1%	14.6	46.1	150.4

Notes

Original design water levels are based on 2105 end of design life.

2.7.12 Elevations for Lift Gates in Open Position

For the storm surge barriers that have lift gates, considerations are provided for the position of the lift gate in the open position. When the gates are in the open position during normal day-to-day conditions, the bottom of the gates shall provide 3 feet of clearance above mean higher high water (MHHW) at the end of the project service life. Positioning the bottom of the gate, when open, above this elevation will ensure that the gate will not be inundated more than needed and that flow will not be impeded by sluicing action under the gate for typical water level and operating

conditions. The additional 3 feet is used to account for potential wave action during normal conditions and allow for clear sight lines underneath the gate which may be needed during visual inspections. This elevation varies per storm surge barrier location. For the Verrazzano Narrows storm surge barrier, this elevation is equal to +8 feet NAVD88, which is the rounded sum of +2.41 feet (MHHW), sea level change (1.82 feet), and the additional 3-foot clearance. Headwall elevations are set according to the table below.

Table 2-18: Elevations for Lift Gates in Open Position

Location	MHHW (ft NAVD88)	Sea Level Rise (ft)	Clearance (ft)	Elevation for Bottom of Gate (in Open Position) (ft NAVD88)¹
Verrazzano Narrows Auxiliary Flow Gates	2.28	1.93	3	+8
Throgs Neck Auxiliary Flow Gates	3.64	1.74	3	+8
Arthur Kill Auxiliary Flow Gates	2.41	2.29	3	+8
Outer Harbor Auxiliary Flow Gates	2.41	2.29	3	+8
Kill Van Kull Auxiliary Flow Gates	2.63	2.29	3	+8
Jamaica Bay Auxiliary Flow Gates	2.41	2.29	3	+8
Hackensack River Auxiliary Flow Gates	2.97	2.29	3	+8
East Chester Creek Auxiliary Flow Gates	3.64	1.74	3	+9
Westchester Creek Auxiliary Flow Gates	3.64	1.74	3	+8
Bronx River Auxiliary Flow Gates	3.64	1.74	3	+8
Flushing Creek Auxiliary Flow Gates	3.64	1.74	3	+8
Sheepshead Bay Auxiliary Flow Gates	2.41	2.29	3	+8
Gerritsen Creek Auxiliary Flow Gates	2.41	2.29	3	+8
Port Washington Flow Gates	3.64	1.74	3	+9
Highlands Flow Gates	2.41	2.29	3	+8
Raritan River Flow Gates	2.41	2.29	3	+8

Note

¹ Elevation = MHHW + RSLC + Clearance, rounded to nearest foot

2.7.13 Direct and Reverse Head Conditions

The SSB has the function to impede storm surge and reduce the threat of flood risk for the area behind it. This results in a direct head difference over the structure. At the same time, once the SSB is closed, the water levels of the interior basin can increase due to inflows from various sources, and in some storm conditions, it is possible to have a reverse head condition over the SSB’s structure. This phenomenon can occur when the storm wind field pushes the water level temporarily higher on the protected side while simultaneously creating a lowering of water levels on the ocean side. Both direct head and reverse head conditions were analyzed and are documented in Annex C.

2.8 Wind

Design wind speeds and parameters according to ASCE 7-16 are included in Table 2-19.

Table 2-19: ASCE 7-16 Design Wind Speed

Parameter	Value
Risk Category	IV
Surface Roughness Category	D
Exposure Category	C
Basic Wind Speed (3 sec @ 33 ft)	130 mph

Wind data for each location are derived from the wind gauges in closest vicinity to the storm surge barrier location and are provided in Table 2-20. Wind roses and statistical data developed for each of these gauges are provided in Figure 2-4 through Figure 2-6.

Table 2-20: Wind Gauges and Respective Applicability to SSB Locations

Location	Closest Wind Gauge	Station Identification
Verrazzano Narrows	John F. Kennedy International Airport	KJFK
Throgs Neck	LaGuardia Airport, NJ	KLGA
Arthur Kill	Linden Airport, NJ	KLDJ
Outer Harbor	John F. Kennedy International Airport	KJFK
Kill Van Kull	Linden Airport, NJ	KLDJ
Jamaica Bay	John F. Kennedy International Airport	KJFK
Hackensack River	Linden Airport, NJ	KLDJ

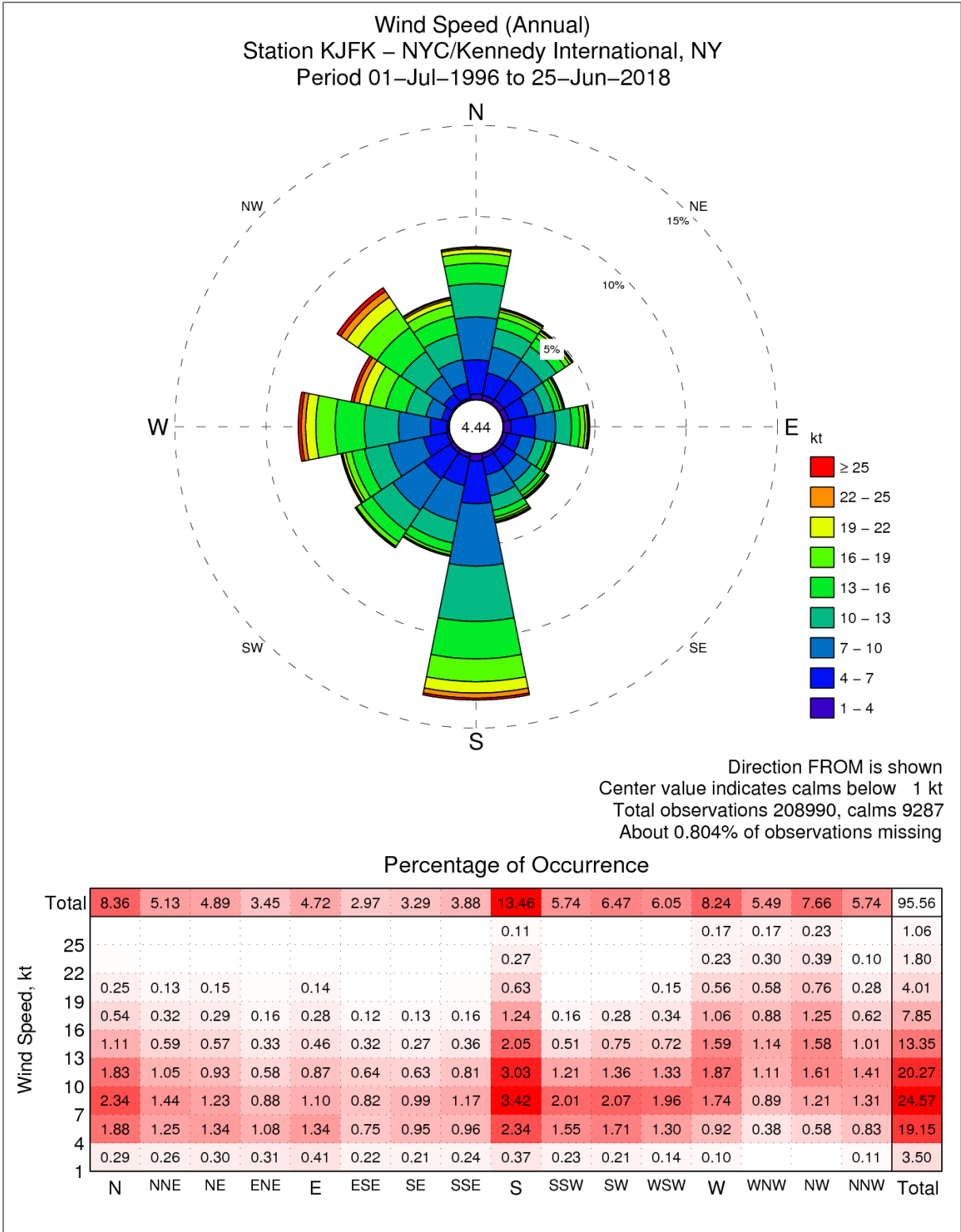
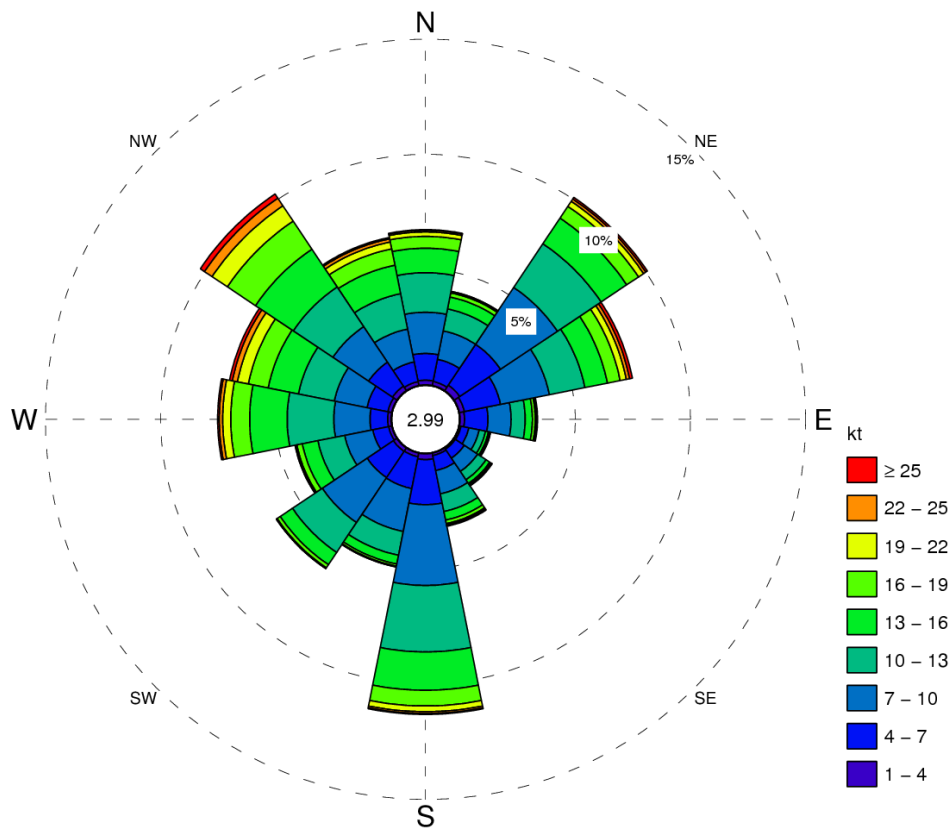

Figure 2-4: Percentage of Occurrence for Wind Speed in knots for John F. Kennedy International Airport (Station KJFK) for a 22-year period

Wind Speed (Annual)
 Station KLGA – NYC/La Guardia, NY
 Period 01-Jan-1980 to 25-Jun-2018



Direction FROM is shown
 Center value indicates calms below 1 kt
 Total observations 370824, calms 11096
 About 0.582% of observations missing

Percentage of Occurrence

Total	6.73	4.16	10.08	7.66	3.36	1.38	1.98	3.23	11.31	5.03	6.29	4.28	7.53	7.17	10.26	6.55	97.01
25				0.13										0.12	0.22		0.83
22			0.12	0.14									0.15	0.22	0.40	0.14	1.44
19	0.19		0.26	0.27					0.25				0.35	0.49	0.80	0.31	3.25
16	0.52	0.18	0.62	0.56	0.12			0.16	0.68		0.16	0.24	0.82	0.88	1.47	0.72	7.35
13	1.06	0.52	1.34	1.00	0.31	0.13	0.19	0.38	1.66	0.39	0.64	0.69	1.63	1.34	1.97	1.26	14.52
10	1.71	0.97	2.28	1.57	0.61	0.28	0.44	0.78	2.89	1.05	1.56	1.18	2.03	1.59	2.07	1.56	22.58
7	1.79	1.26	2.97	2.16	1.00	0.46	0.69	1.03	3.51	1.90	2.34	1.24	1.57	1.44	1.86	1.45	26.69
4	1.16	0.98	2.13	1.60	1.02	0.34	0.47	0.66	1.96	1.41	1.37	0.70	0.77	0.92	1.25	0.87	17.63
1	0.20	0.17	0.28	0.22	0.19			0.10	0.25	0.16	0.18	0.13	0.14	0.17	0.23	0.17	2.72
	N	NNE	NE	ENE	E	ESE	SE	SSE	S	SSW	SW	WSW	W	WNW	NW	NNW	Total

Figure 2-5: Percentage of Occurrence for Wind Speed in knots for La Guardia Airport (Station KLGA) for a 38-year period

Wind Speed (Annual)
 Station KLDJ – Linden, NJ
 Period 24–Mar–2008 to 25–Jun–2018

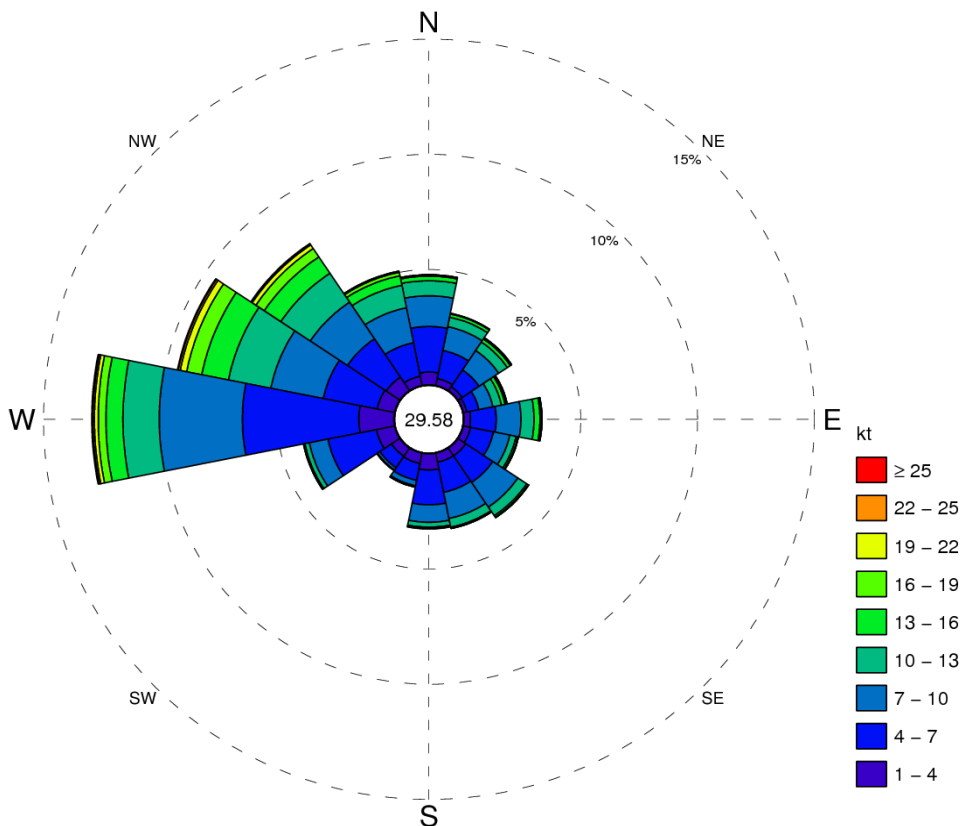

Direction FROM is shown
 Center value indicates calms below 1 kt
 Total observations 184013, calms 54432
 About 27.6% of observations missing

Percentage of Occurrence

Total	4.77	3.19	2.76	1.91	3.34	2.41	3.63	3.33	3.26	1.51	1.18	3.98	12.94	9.48	7.68	5.06	70.42
25																	0.10
22																	0.24
19													0.16	0.28	0.19		0.75
16													0.33	0.66	0.43	0.15	1.90
13	0.20	0.14	0.16	0.16	0.25								0.73	1.17	0.85	0.42	4.40
10	0.65	0.42	0.44	0.37	0.56	0.27	0.45	0.39	0.22			0.20	1.56	1.85	1.51	1.00	9.96
7	1.34	1.05	1.01	0.62	1.06	0.71	1.29	1.16	0.76	0.24	0.12	0.81	3.56	2.29	1.92	1.55	19.46
4	1.98	1.24	0.88	0.53	1.10	1.00	1.39	1.33	1.51	0.75	0.60	2.12	4.98	2.35	2.00	1.48	25.24
1	0.55	0.30	0.21	0.15	0.28	0.32	0.40	0.40	0.70	0.46	0.43	0.79	1.50	0.77	0.70	0.41	8.36
	N	NNE	NE	ENE	E	ESE	SE	SSE	S	SSW	SW	WSW	W	WNW	NW	NNW	Total

Figure 2-6: Percentage of Occurrence for Wind Speed in knots for Linden Airport, NJ (Station KLDJ) for a 10-year period

2.9 Geotechnical

This section will discuss the existing subsurface information that was reviewed and integrated into design soil characterization and strength parameters. These were utilized to determine the preliminary foundation design for each alternative.

Note that site-specific subsurface investigations were not conducted as part of this study. The PDT had to rely on publicly available geological maps and readily available data from nearby projects to characterize the general subsurface conditions. For those storm surge barriers that are selected for further study, a more detailed analysis is recommended for the detailed design phase.

The storm surge barriers on the south and east of the project area are generally located in a geological, structural, and topographic province known as the Atlantic Coastal Plain. In this area, the Coastal Plain consists of unconsolidated deposits of sands, silts, and clays that gently dip seaward. The coastal plain deposits are typically overlain with younger glacial deposits of till, outwash material, and moraine deposits. More recent deposits of fill, stream material, and reworked sediments may overlie the glacial deposits. The Verrazzano Narrows in particular were formed when a glacial lake of the Wisconsin ice age broke through a morainal dam stretching from Staten Island through Long Island. The resulting outwash scoured overlying materials down to bedrock elevation, and the resulting chasm has since filled in with alluvial sands, silts, and clays. Bedrock at this location consists primarily of gneiss, schist, marble, and quartzite.

On the west regions of the project area, SSBs are located in waterways within the Newark Basin, a partial rift which has been filled with sand, silt, and clay sediment eroded from the surrounding basin walls and hills of the Piedmont region.

SSBs within the northern regions of the project area are located in waterways within the Manhattan Prong geologic formation. This area typically consists of metamorphic bedrock overlain by recent alluvial deposits of sand, silt, and clay. At the Hackensack River SSB, local geology generally consists of salt marsh overlying glacial lake deposits and sedimentary bedrock (primarily shale and sandstone).

2.9.1 Settlement & Regional Subsidence

The potential for regional subsidence has not been studied in detail during the feasibility phase. However, published subsidence values of approximately 2-3 mm/year for the New York City region appear reasonable for preliminary planning.

At the Verrazzano Narrows location, substantial reclamation fill is required to construct and protect the gate structures, and this fill will be subject to large settlements due to self-consolidation and long-term consolidation of the underlying fine-grained alluvial sediments. Primary consolidation is expected to be substantially complete prior to installation of major structural elements.

All foundations for the three SSBs under consideration are assumed to be pile supported. Due to the anticipated presence of relatively shallow bedrock, the Hackensack River foundations will require tipping the piles within bedrock. The foundation piles for Jamaica Bay and Verrazzano Narrows storm surge barriers are anticipated to be tipped within cohesive or granular soils. Table 2-21 provides estimated settlement for each of the three SSBs under consideration during the feasibility phase.

Table 2-21: Estimated Settlement for the Verrazzano Narrows, Jamaica Bay, and Hackensack River Storm Surge Barriers

Location	Settlement (ft)
Verrazzano Narrows	0.5
Jamaica Bay	0.5
Hackensack River	-

2.9.2 Design Subsurface Profiles

Design soil profiles were developed for the Verrazzano Narrows and Jamaica Bay sector gates. At Verrazzano Narrows there are two proposed islands, east and west, and separate soil profiles were developed for the short-term (unconsolidated) and long-term (consolidated) cases of each island. The geotechnical profiles shown are based on available historic borings from the adjacent water siphons. The following tables provide the soil properties used for design in each case.

Table 2-22: Verrazzano Narrows East Island Soil Profile (Unconsolidated)

Soil Description	Top of Layer Elevation (ft. NAVD)	Saturated Unit Weight (pcf)	Effective Unit Weight (pcf)	Phi (degrees)	Cohesion (psf)
Medium Dense Sand Fill	+10	110	46	30	-
Loose Silty Sand w/ Gravel	-39	105	41	31	-
V. Soft Silt and Clay w/ Gravel	-81	95	31	10	200
Soft Silty Clay w/ Gravel	-130	100	36	10	265
Soft Silt and Clay w/ Sand and Gravel	-144	100	36	10	340
Medium Dense Sand	-105	115	51	33	-
Dense to V. Dense Sand	-119	125	61	38	-

Table 2-23: Verrazzano Narrows East Island Soil Profile (Consolidated)

Soil Description	Top of Layer Elevation (ft. NAVD)	Saturated Unit Weight (pcf)	Effective Unit Weight (pcf)	Phi (degrees)	Cohesion (psf)
Medium Dense Sand Fill	+10	110	46	30	-
Loose Silty Sand w/ Gravel	-46	105	41	31	-
Firm Silt and Clay w/ Gravel	-64	110	46	10	730
Firm Silty Clay w/ Gravel	-68	110	46	10	860
Stiff Silt and Clay w/ Sand and Gravel	-91	115	51	10	1,160
Medium Dense Sand	-105	115	51	33	-
Dense to V. Dense Sand	-119	125	61	38	-

Table 2-24: Verrazzano Narrows West Island Soil Profile (Unconsolidated)

Soil Description	Top of Layer Elevation (ft. NAVD)	Saturated Unit Weight (pcf)	Effective Unit Weight (pcf)	Phi (degrees)	Cohesion (psf)
Medium Dense Sand Fill	+10	110	46	30	-
Loose Sand w/ Silt and Gravel	-50	105	41	31	-
Soft Silty Clay w/ Gravel	-99	105	41	10	300
V. Soft Silty Clay w/ Gravel	-110	110	46	10	675
V. Soft Silty Clay w/ Gravel	-120	110	46	10	500
Hard Silty Clay	-142	130	66	-	4,000

Table 2-25: Verrazzano Narrows West Island Soil Profile (Consolidated)

Soil Description	Top of Layer Elevation (ft. NAVD)	Saturated Unit Weight (pcf)	Effective Unit Weight (pcf)	Phi (degrees)	Cohesion (psf)
Medium Dense Sand Fill	+10	110	46	30	-
Loose Sand w/ Silt and Gravel	-57	105	41	31	-
Stiff Silty Clay w/ Gravel	-106	110	46	10	1,000
Stiff Silty Clay w/ Gravel	-115	110	46	10	1,145
Stiff Silty Clay w/ Gravel	-123	115	51	10	1,350
Hard Silty Clay	-142	130	66	-	4,000

A single geotechnical profile was developed based on available historic borings from 1936 explorations for the Marine Parkway Bridge.

Table 2-26: Jamaica Bay Soil Profile

Soil Description	Top of Layer Elevation (ft. NAVD)	Saturated Unit Weight (pcf)	Effective Unit Weight (pcf)	Phi (degrees)	Cohesion (psf)
Loose Fine Sand	-36	95	31	29	-
Loose Sand	-44	105	41	30	-
V. Loose Sand	-52	95	31	28	-
Loose Sand	-56	105	41	30	-
V. Loose Fine Sand	-66	95	31	28	-
Medium Dense Fine Sand	-88	120	56	33	-
Loose Fine Sand, some Gravel	-112	100	36	29	-
Medium Dense Sand	-132	115	51	31	-

Soil profiles for the Hackensack River storm surge barrier were developed for an initial assessment of pile geotechnical capacity of open-ended steel pipe piles. The stratigraphy was based on the information found in the Interim Report and information from projects on the area. According to the Interim Report, soil strata near the HR SSB have the following characteristics:

- Salt-marsh deposits: Organic silts and clays with sand and shells. Soft soils, 5 to 10 feet thick.
- Alluvium and glacial lake deposits, extends between upper soft silts and bedrock, a mix of sand clay and silts of varying competency.
- Sedimentary rock: Shale or sandstone, with a top of rock 60 to 80 feet below mean low water (MLW).

For the feasibility study, the HR SSB navigable sector gate monolith, auxiliary lift gate sills, and T-wall “dam sections” are founded on steel pipe piles. The auxiliary lift gate piers/towers are founded on drilled shafts and supplemental pipe piles.

For most features of the HR SSB, the assumed top-of-bedrock elevation is so shallow that drilled shafts and pipe piles have rock sockets. (Refer to the HR SSB drawing sheets.)

The assumed soil profile and properties are shown in Table 2-27.

Table 2-27: Hackensack River Soil Profile

Soil Description	Top of Layer Elevation (ft. NAVD)	Saturated Unit Weight (pcf)	Effective Unit Weight (pcf)	Phi (degrees)	Cohesion (psf)	Unconfined Compression Strength (psi)
River Sediments	Top of Mudline	110	46	-	200	-
Sand	-30	125	61	32	-	-
Rock	-65	150	86	28	-	5000

2.10 Materials

The following material and design specifications are recommended as minimum parameters for the proposed project. All materials shall be new and of the best quality of their respective kinds as described or if not stated, to be at least in accordance with the relevant ASTM International (ASTM) standards.

2.10.1 Reinforced Concrete

The classification of concrete structures presented in EM 1110-2-2104, Strength Design of Reinforced Concrete Hydraulic Structures, is dissimilar and simpler than ASD or LRFD classification for steel structures. Instead of a strength or allowable stress reduction factor, a hydraulic load factor is utilized based on classification. Structures may be classified as either hydraulic or not, and elements may be classified as in direct tension or not.

The hydraulic load factor is employed to account for cracking, vibration, concrete degradation, and other serviceability issues associated with the unique function and environment of hydraulic structures. Elimination of a separate serviceability analysis is an additional benefit.

General considerations and “best practices” include the following for reinforced concrete:

- 1) All concrete work shall be performed in accordance with ACI 301 "Specifications for Structural Concrete”, and all reinforced concrete materials shall be proportioned, fabricated, delivered, and placed in accordance with ACI 318.
- 2) All cast-in-place, precast, and prestressed concrete shall be normal weight.

- 3) Cement shall conform to the requirements of ASTM C 150, Type II, unless otherwise specified.
- 4) Concrete aggregates shall conform to the requirements of ASTM C 33.
- 5) Admixtures for concrete shall be in accordance with manufacturer's recommendations and shall conform to the requirements of ASTM C 494.
- 6) Non-shrink admixtures shall be considered to control cracking of concrete deck slabs, and other exposed concrete surfaces where surficial cracking may be considered undesirable due to exposure conditions, including the use of deicing salts.
- 7) Mix water for concrete shall be clean, fresh, and potable.
- 8) Precast and cast-in-place concrete shall be afforded corrosion protection and durability enhancement measures, as required, such as the use of increased concrete cover over reinforcing steel, air-entraining admixtures, pozzolanic compounds (e.g., fly ash, slag), and other approved methods as specified.
- 9) Cast-in-place concrete shall have a minimum compressive strength (f'_c) of 5,000 psi (pounds per square inch) at 28 days.
- 10) Precast, non-prestressed concrete shall have a minimum compressive strength (f'_c) of 5,000 psi at 28 days.
- 11) Precast, prestressed concrete shall have a minimum compressive strength (f'_c) of 6,000 psi at 28 days.
- 12) Cementitious grout shall be non-metallic and non-shrink with a minimum compressive strength of 8,000 psi at 28 days, unless otherwise specified.
- 13) The minimum concrete cover over reinforcing steel shall be 3 inches, unless otherwise indicated.
- 14) Chamfer all exposed external corners of concrete with 45 degree, 3/4 inch chamfers, unless otherwise indicated.
- 15) All joints between cast-in-place concrete and hardened concrete shall be cleaned with a roughened surface of 1/4 inch amplitude and coated with an epoxy bonding compound in accordance with manufacturer's recommendations, unless otherwise indicated.
- 16) All detailing, fabrication, and erection of reinforcing steel shall conform to the latest edition of the "ACI Manual of Concrete Practice", including but not limited to ACI 301 and ACI-SP-66 "ACI Detailing Manual".
- 17) Reinforcing steel for concrete shall conform to the requirements of ASTM A 615, grade 60, unless otherwise specified. Epoxy-coated reinforcing steel will not be used for this project.

- 18) Galvanized reinforcing steel will be considered; galvanized reinforcing steel, where used, shall conform to the requirements of ASTM A 767.
- 19) Reinforcing steel to be welded shall conform to the requirements of ASTM A 706, grade 60.
- 20) Prestressing steel for concrete shall be 7-wire low-relaxation strands conforming to ASTM A 416, grade 270, unless otherwise specified.
- 21) Welded wire fabric reinforcement for concrete shall conform to the requirements of ASTM A 185.
- 22) Mild steel spiral reinforcement for concrete shall conform to the requirements of ASTM A 82.
- 23) All reinforcing bar splices shall be Class “B” tension lap splices in accordance with ACI 318, Chapter 12, unless otherwise indicated.

2.10.2 Hydraulic Structural Steel Structures

EM 1110-2-2105, Design of Hydraulic Steel Structures, augments strength reduction factors from the AISC Manual of Steel Construction based on structure classification. The allowable stress (ASD) or design strength (LRFD) for steel structural elements are further reduced to account for the unique functions and environmental conditions associated with hydraulic structures.

Unlike the stability of concrete structures, considerations for the classification of the steel sector gate leafs per ASD requirements presented in Chapter 4 of EM 1110-2-2105 are more diverse. Those considerations result in three structure classifications with specific limits on allowable stress associated with each. Those considerations, and the resulting allowable stresses as stated in Chapter 4, are presented below:

- Type A – Hydraulic steel structures (HSS) which are used for emergency closures and which are subject to severe dynamic (hydraulic) loading or are normally submerged where maintenance is difficult, and removal of the HSS causes disruption of the project. For Type A HSS, the allowable stress shall be 0.75 times that allowed by ASIC (1989).
- Type B – HSS which are normally hydraulically loaded and are not subjected to unknown dynamic loading. For Type B HSS, the allowable stress shall be 0.83 times that allowed by AISC (1989).
- Type C – HSS which are used for maintenance and are not considered emergency closures. For Type C HSS, the allowable stress shall be 1.1 times that allowed by AISC (1989). These allowable stresses are the maximum allowable values and may not be further increased due to Group II loading.

The steel sector gates are best classified as a Type A structure since all of the considerations noted are clearly true in some cases and at least arguably true in others. Even if some of the characteristics are called into question, Chapter 4 of EM 1110-2-2105 also states, “If a structure has characteristics of more than one type, the lesser allowable stress is required.” Therefore, since the NYNJHAT

gates are used for emergency closure and may be subjected to dynamic loading, they should be classified as Type A structures as well.

See Table 2-4 in the AISC Steel Construction Manual, 15th ed. for ASTM material standards for structural shapes, Table 2-5 for plates and bars, and Table 2-6 for fasteners. Engineers anticipate that the sector and lift gates, which are subject to immersion, will be welded rather than bolted. In specific areas, see the 2020 NYNJHAT feasibility design sketches for yield strengths for steel.

The steel gates are subject to Severe Atmospheric Weathering. For the purposes of coating and steel material selection, immersion is anticipated to occur one to three times per year. Ref. EM 1110-2-3400 Sec. 5-4.

Weathering steel shall not be specified. Weathering steel, which is mainly used for the architecturally exposed and unpainted steel exoskeletons of buildings and for architecturally exposed and unpainted steel members of bridges that are distant from (or high above) salt spray, is a poor choice in environments that are constantly wet or humid. Weathering steel should not be used where steel is subject to salt spray, salt splashing, or in other coastal conditions. (The lift gates are typically stowed out of the water and are rarely immersed or submerged. That said, ETL 1110-2-584 Sec. 6.2.1.2 states that “Weathering steel shall not be used for submerged conditions.”)

Engineers anticipate that for future 100% design and detailing, difficult-to-access portions of the steel gates, such as the ends of the horizontal truss chords where they extend into the abutment recess, will be drawn and specified to wall thicknesses increased a minimum of 1/8 inch beyond what is required by design. Ref. ETL 1110-2-584 Sec. 6.2.1.

Engineers expect the future 100% design to rely on coatings and material selection to control corrosion at the gates rather than to provide a uniform corrosion allowance to all steel members. Ref. ETL 1110-2-584 Sec. C6.2.1.6.

It is assumed that the 100% design will specify a similar coating system for severe weathering as would be specified for normal weathering, but that the surface preparation will be upgraded with one or more additional coats of primer or finish paint. Ref. EM 1110-2-3400 Sec. 5-4 and 5-5.

2.10.3 Cathodic Protection

Cathodic protection may be employed in conjunction with coatings to increase the service life of the corrosion protection system and to prolong the initial onset of corrosion. Cathodic protection may be passive or active. Active systems utilize a small, impressed current through the steel whereas passive systems use galvanic anodes, which are welded to the steel. Both systems are applicable to the submerged zone of the structure. They do not provide protection within the atmospheric zone, and provide only minimal protection within the splash zone, to the extent that it is common engineering practice to ignore any potential benefit from the passive or active cathodic protection within this region.

2.10.4 Dissimilar Metals

Where dissimilar metals are in contact, such as Aluminum and Structural Steel, the surfaces shall be protected with a coating conforming to SSPC Paint 25 to prevent galvanic or corrosive action. The connections between the dissimilar metals shall be with stainless steel bolts and washers with nylon washers placed in between the stainless-steel washers and painted surfaces. Protective sleeves may also be employed such that the bolt shaft does not directly contact the connecting elements.

The Nylon Washers shall meet the requirements of ASTM D4066. Stainless steel bolts shall meet the requirements of ASTM F593.

2.11 Loads for Storm Surge Barriers

2.11.1 Gravity Loads

2.11.1.1 Dead Loads

Dead loads will include the self-weight of the structural members as well as the weight of all the permanent equipment and appurtenances which do not change during the operation of the structure. This includes handrails, light poles, mechanical and electrical systems, and all elements whose weight is not modeled within a finite element analysis such that the weight and mass of these elements are captured. Generally, the following loads shall be considered:

- The weight of secondary and tertiary members not modeled within a calculation but are part of the structural system being evaluated; and
- Fixings, including floor decking, cladding, insulation, and fire proofing materials.

The following material densities shall be used when determining dead load:

- Water: 63 pcf
- Reinforced concrete: 155 pcf
- Unreinforced concrete (e.g., tremie concrete): 145 pcf

2.11.1.2 Live Loads

Live loads for design purposes depend on the structural component being considered. Live loads shall be applied such that they are additive to worst-case member demands.

2.11.1.3 Vehicle Live Loads

For the vehicles described in Section 2.6.2.1, an H 15-44 AASHTO design truck shall be assumed. This vehicle has a total weight of 30 kips. Axle loads are 6 kips (front) and 24 kips (rear) with an axle spacing of 14 feet.

Following AASHTO recommendations, the design truck load is combined with a distributed lane load. Lane load shall be taken as 0.48 kip/ft uniformly distributed in the longitudinal direction. In the transverse direction this load shall be assumed to act over a 10-foot width.

Roadway railing shall be designed for a 10 kips impact load. At sector gate crossings, where speeds are expected to be reduced, rail impact load can be taken as 6 kips (consistent with ASCE 7 provisions for passenger vehicles).

Design load for pedestrians only railings shall be taken as 50 lbf/ft both transversely and vertically, acting concurrently. In addition to these distributed loads, a single 0.20 kips concentrated load shall be applied at any point in any direction at the top of the element.

2.11.2 Hydrostatic Loads

During storm events, the barriers will be closed. Differential head between the storm surge side and the upland side of the barrier will result in hydrostatic loading and shall be included as needed within the appropriate load combinations. For conditions where the upland side water level may be higher than the storm surge side, reverse head conditions shall also be considered. Differential hydrostatic head is described in Section 0..

2.11.3 Wind Loads

Wind load on structures shall be based on the wind load requirements specified in ASCE 7-16 and the USACE Hurricane Storm Damage Risk Reduction System (HSDRRS) Design Guidelines. Per ASCE 7-16, the structures are Risk Category IV, and the design wind speed is 130 mph (3-second gust at 33 feet above ground, Exposure Category C). This corresponds to a 0.0588% annual exceedance probability, or a 1,700-year mean recurrence interval.

2.11.4 Wave Loads

Wave loads exerted on the storm surge barriers when the barrier is closed shall be calculated using Goda's formula for deriving wave pressure distributions for vertical breakwaters as described in the Coastal Engineering Manual (USACE, 2002).

2.11.5 Current Loads

Current loads will not be included at this stage of the conceptual design as the principal design elements are not governed by current loads.

2.11.6 Seismic Loads

2.11.6.1 Dynamic Earth Pressure

Seismic forces may cause increased lateral earth pressures on earth retaining structures accompanied by increased lateral movements of the structure itself. The degree of ground shaking that retaining structures will be able to withstand will depend, to a considerable extent, on the margin of safety provided for the static loading conditions. In general, retaining structures designed

conservatively for static loading conditions may have a greater ability to withstand seismic forces than those designed more economically by less conservative procedures. Dynamic lateral earth pressure on retaining structures will be determined by the method developed by Mononobe and Okabe.

2.11.6.2 Earthquake

The structures shall be designed to resist applicable earthquake motions. The relationship of the site to active faults, the seismic response of soils at the project site, and the dynamic response characteristics of the total structure and its individual components shall be determined in accordance with ASCE 7-16.

- Seismic Use Group I, Risk Category II
- $S_{DS} = 0.211$
- $S_{D1} = 0.095$

2.11.7 Impact Loads

Accidental collision between vessels and any of the SSB structures could pose grave consequences in terms of risk, reliability, operability, and damage. While the navigable gates are largely protected from collision during normal or typical transits, due to the fact that the gates are recessed in either abutment or island-type gate slots, there remains the possibility that portions of the structures could be contacted. Moreso, contact between an aberrant vessel and the non-navigable gated structures that are difficult to protect could lead to significant gate and pier damage.

The general design requirements for movable bridge piers includes the following prescriptive guidelines: “Movable bridge piers which house mechanical equipment or support movable machinery should be fully protected from vessel contact by aberrant vessels. There should be no contact of the vessel with the pier when the protection system is in the fully deformed position and the vessel has been stopped.” The same level of protection will be difficult to achieve for the non-navigable portions of the SSB.

There are few existing SSBs with major vessel traffic combined with non-navigable lift gates; the VN SSB and JB SSB will each be unique. The design impact load for vessel collision will need to factor in risk tolerance, operations and maintenance (O&M,) and whether spare replacement lift gates will be fabricated, stored, and maintained.

It is assumed that the steel gates and concrete piers will not be designed to withstand collision with vessels under power since doing so would be both technically challenging and cost prohibitive.

Navigable gates will be provided with protection structures and guide walls at all SSBs as needed.

The steel, navigable sector- and non-navigable lift-gates and the concrete piers and dam sections will be designed for a nominal impact force of 250 kips, generally considered as a minimum impact force generated by a single drifting, barge-type vessel. The design nominal impact force during a storm is 250 kips. The design nominal impact force during navigation of the nearby navigable channels is 250 kips.

Load conditions will be as follows:

- Water at NAVD88 El. -3.4 or NAVD88 El. 3.0 and authorized vessel applied to surfaces not protected by dolphins or approach walls
- Water at NAVD88 El. -3.4 or NAVD88 El. 3.0 & 250 kips applied to any steel gate.
- 250 kips applied any height from NAVD88 El. 6.0 to top of structure applied to surfaces not protected by dolphins or approach walls during a storm

For advanced design of the SSB, it is recommended that vessel collision risk evaluations be performed for each barrier location. This would need to include identification of fleet characteristics, geometric evaluation, characterization of transit speeds, assessing probability of aberrancy, and determination of vessel impact forces. These forces would need to be assessed with respect to the likely extent of impact damage, the probability of collision collapse, and the operational and repair scenarios that could be undertaken to mitigate the aberrant collision between vessel(s) and one or more piers.

2.11.8 Structure Classification and Global Stability

Structure classification is an important component of the design process with respect to risk management. Although the criteria may vary according to structure type, component type, and material, failure consequences are the most important consideration when classifying a structure. Other considerations include, but are not limited to, ease of inspection and maintenance, uncertain effects of applied loads, and effects of environment degradation.

Certain classification considerations are evaluated for the various components of the concept designs. Structure economic optimization, reliability, and safety are the result of proper structure classification, when coupled with appropriate design methodologies. Those structures that are easily maintained and have inconsequential failure scenarios may be more liberally designed to reduce cost. Conversely, structures where the opposite is true are necessarily robust and more expensive. This is achieved directly by assigning specific allowable stresses or minimum factors of safety to particular structure classifications.

In the case of global stability, concrete structures are classified as either “Normal” or “Critical” by the guidelines provided in Appendix H of EM 1110-2-2100. Critical structures are defined as those where structural failure will directly or indirectly result in the loss of life. Examples of critical structures may include gravity dams, arch dams, urban flood walls, and coastal flood walls. Project performance objectives stated in Appendix H include:

- Retain and release impoundments in a planned regulated manner.
- Prevent structure damage under usual and unusual load conditions.
- Prevent Structure collapse under extreme load conditions.
- Allow adequate time under emergency conditions to evacuate people from areas subject to flooding.
- Remain operational to permit a controlled release of impounded water following major flood and earthquake events.

Although Appendix H states specifically “loss of life is the only consequence applicable to the structure classification process,” consideration of economic impacts is prudent as well. It is possible that loss of life would occur in the general metropolitan region should any component of the surge barrier fail, but it is certain that the economic impacts would be far reaching. Blockage of the navigational passages could also be costly due to the interruption of maritime commercial activity and its far-reaching effects on supply lines, trade, and the general availability of critical goods and services. When also considering that Appendix H does not specify a minimum number of lost lives for classification, the only conclusion to draw is that all structures that comprise the various surge barriers should be classified as “Critical” with respect to stability.

Codes require the classification of load conditions imposed on structures for the economic and risk management concerns. Probabilistic methodologies are employed to optimize structure designs so that they are reasonably safe for all load conditions, but also practical. The factors of safety (FS) associated with common events are necessarily high, while FS for unlikely events are correspondingly low.

The design memorandums discuss the probability of many of the considered load conditions, but generally in qualitative or relative terms. In most cases, superposition of specific return period ranges and/or load group classifications was necessary for the purpose of evaluation.

Load conditions for global stability are classified in three categories with probabilistic ranges provided for each to aid the designer in the classification process. The three modern categories presented in Chapter 3 of EM 1110-2-2100 and the appropriate probabilistic range for each are presented in Table 2-28 below.

Table 2-28: EM 1110-2-2100, Load Condition Probabilities

Load Condition Categories	Annual Probability	Return Period
Usual	Greater than or equal to 0.10	Less than or equal to 10 years
Unusual	Less than 0.10 but greater than or equal to 0.0033	Greater than 10 years but less than or equal to 300 years
Extreme	Less than 0.0033	Greater than 300 years

Generally, load conditions that occur less frequently are of a larger magnitude, but exceptions are possible. Any of the three categories may control the design, and the appropriate classification is important. Therefore, in addition, Table 2-28 provides qualitative definitions of each of the three categories which are presented below.

- *Usual* loads refer to loads and load conditions, which are related to the primary function of a structure and can be expected to occur frequently during the service life of the structure. A usual event is a common occurrence, and the structure is expected to perform in the linearly elastic range.
- *Unusual* loads refer to operating loads and load conditions that are of infrequent occurrence. Construction and maintenance loads, because risks can be controlled by specifying the sequence or duration of activities, and/or by monitoring performance, are

also classified as unusual loads. Loads on temporary structures which are used to facilitate project construction, are also classified as unusual. For an unusual event, some minor nonlinear behavior is acceptable, but any necessary repairs are expected to be minor.

- *Extreme* loads refer to events which are highly improbable and can be regarded as emergency conditions. Such events may be associated with major accidents involving impacts or explosions and natural disasters due to earthquakes or flooding which have a frequency of occurrence that greatly exceeds the economic service life of the structure. Extreme loads may also result from the combination of unusual loading events. The structure is expected to accommodate extreme loads without experiencing a catastrophic failure, although structural damage that partially impairs the operational functions are expected, and major rehabilitation or replacement of the structure might be necessary.

3 Verrazzano Narrows Storm Surge Barrier

3.1 Location

The Verrazzano Narrows storm surge barrier is situated where the Hudson River transitions into Raritan Bay. The proposed storm surge barrier spans from Staten Island to Brooklyn, NY, just upriver from the Verrazzano Narrows Bridge. The distance between the two shores is approximately 4,800 feet (0.9 miles). Water depths vary, with depths typically ranging from 30 feet to 50 feet outside the federal navigation channels, and depths exceeding 70 feet at certain locations within the channel. Depths vary considerably across the Verrazzano Narrows, with the deepest point exceeding 150 feet. Depths are shallower and more consistent at locations further north of the Verrazzano Narrows Bridge, and these locations are preferred.

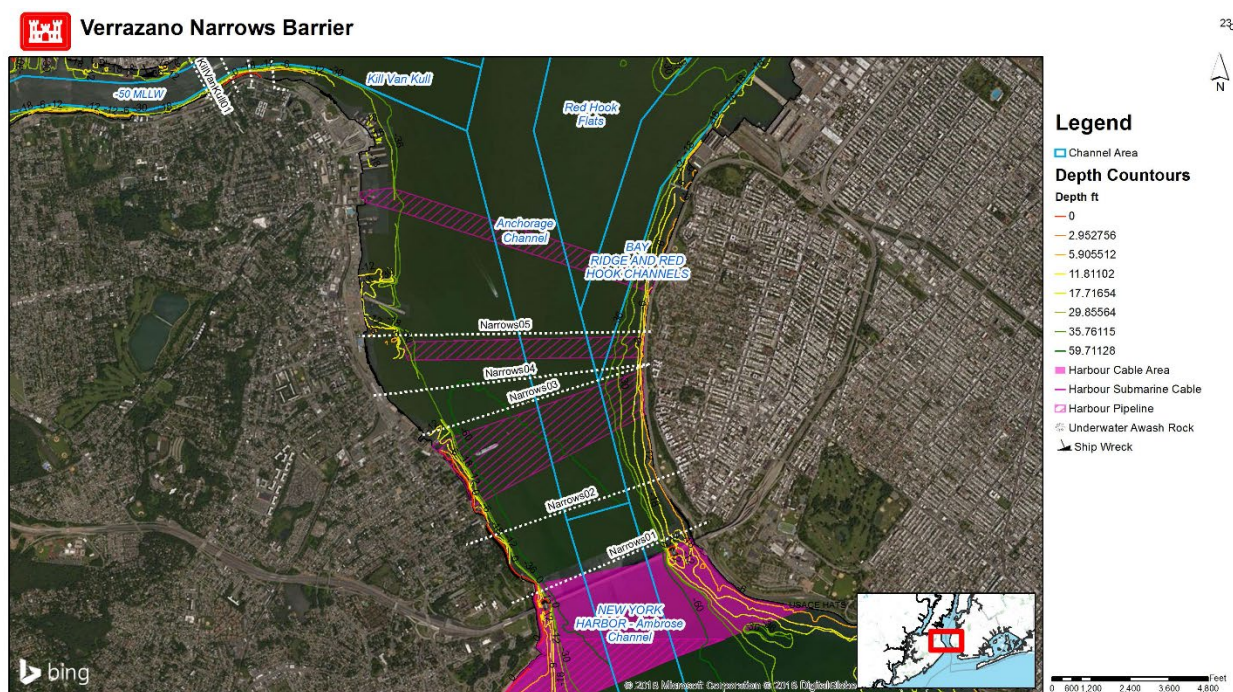

Figure 3-1: Area of Interest for the Verrazzano Narrows Storm Surge Barrier Which Spans from Staten Island to Brooklyn (NY)

3.2 Dimensions of the Navigable Passages

The design development of the minimum practical dimensions of the navigable passages of the SSBs follows from the navigation assessment as presented in Figure 3-1. The design vessel specifications and channel dimensions were established following PIANC guidance. Annex A details the maritime traffic study and the required minimum geometry for the navigable passages. The following sections provide a brief synopsis of the conceptual design development for the navigable passages. A summary overview is presented at the end of this Section in Table 3-1.

3.2.1 Navigable Passage Dimensions Verrazzano Narrows

The storm surge barrier from Staten Island to Brooklyn would require at least two navigable passages:

- 1) Ambrose Channel Navigable Passage Opening: minimum 1,400 feet wide
 - PIANC guidance to set navigational opening: to a minimum of 968 feet and 1,428 feet for one-way and two-way traffic, respectively. Rounded to the nearest hundred, 1,400 feet is considered a conservatively appropriate value for use as a preliminary estimate in the overall storm surge barrier feasibility study.
 - Set sill of Navigable Passage at -55 feet MLLW (Authorized Channel Depth equals -53 feet MLLW, and an additional 2-foot clearance below design channel is included to account for the hard-bottom structure). -55 feet MLLW equals -58 feet NAVD88.
 - Air draft is controlled by the Verrazzano Bridge at 228 feet. This clearance is adopted as a conservative assumption, which in practicality for the design of moveable gates translates to unrestricted air clearance.

In addition to the main navigation channel, the AIS data suggests that there is a high volume of smaller traffic. It would be advisable to include at least one smaller, navigable gate in the storm surge barrier to pass smaller vessels, to keep the smaller vessels out of the main navigation channel. Enclosure 1 details the selection of the design vessel and analyses to establish the minimum practical width for the secondary navigable passage.

- 2) Secondary Navigable Passage on East Side of Main Channel: 200 feet wide (one-way vessel traffic)
 - PIANC guidance to set navigational opening: minimum 178 feet
 - Set sill of Navigable Passage at -42 feet MLLW. Authorized Channel Depth is -40 feet MLLW, and an additional 2-foot clearance below the design channel is included to account for the hard-bottom structure. -42 feet MLLW equals -45 feet NAVD88
 - Air draft: unrestricted⁶

It should be noted that the dimensions of the navigable passage for the Ambrose Channel is larger than any gated opening in constructed storm surge barriers (Maeslant Barrier in The Netherlands spans 1200 feet). The findings presented herein are a preliminary assessment and further refinement of the gate dimensions and gate configurations (including layout, number, and width) will need to occur during later stages in the design.

⁶ Originally identified as 50 ft vertical air draft, which in practical terms means unrestricted.

Table 3-1: Minimum Practical Dimensions for the Navigable Passages of the Verrazzano Narrows SSB

Location	Federal Channel	Existing Depth (ft)	Minimum Practical Width of Opening (ft)	Authorized Channel Depth (ft NAVD88)	Minimum Depth of Opening (ft NAVD88)	Air Clearance (ft NAVD88)
Verrazzano Narrows	Ambrose Channel	70-75	1,400 ²	-56	-58	Unrestricted
Verrazzano Narrows	Secondary Navigation Channel	20-25	200 ¹	-43	-45	Unrestricted

Notes:

1 Practical width of navigable passage based on one-way traffic

2 Practical width of navigable passage based on two-way traffic

3.3 Navigable Gate Type Selection

Following the minimum design dimensions outlined in Table 3-1, a suitable gate type has preliminarily been selected. Annex A includes an overview of the supplemental data from Mooyaart and Jonkman (2017), which provides an overview of characteristics of constructed storm surge barriers. In addition, Annex A includes an overview of hydraulic gate types used in navigable storm surge barriers and lists general advantages and disadvantages of each gate type. Using the data set and the listed advantages and disadvantages, this appendix provides a cursory review of the suitability of each gate type for the navigable passage. Based on the evaluation that is provided in Annex A the sector gate (vertical axis) and floating sector gate are preliminarily selected for the conceptual design of the navigable passages.

3.4 Auxiliary Flow Gates

For the auxiliary flow gates, a standard gate span of 150 feet is preliminarily selected based on the review of gate characteristics as presented in Mooyaart and Jonkman, 2017, and in Annex A. 150 feet is considered to be a reasonable assumption, where this width falls within the range of gate spans for constructed storm surge barriers. Some SSB locations have spatial constraints, and smaller gate spans may be needed. Due to the variations in depth along the SSB alignment, it is expected that varying gate sizes will be needed. Varying gate sizes will allow the design to follow the natural bathymetric contours of the area while maintaining a large open cross-section for flow. To minimize construction complexity and allow for optimization through the economies of scale, the gate sill elevations are preliminarily assumed to vary in increments of 5 feet. The sill elevation of the auxiliary flow gates is to be above the existing bed elevation such that the potential for sedimentation or siltation at the bottom of the sill is minimized.

The design elevation of the storm surge barriers is provided in Section 2.7.11. To reduce the gate size, weight, and overall complexity of the hoisting mechanisms, it is proposed to include a solid, non-moveable wall. For water control structures, this is commonly referred to as a headwall. An example of a SSB with and without headwall is provided in Figure 3-2.

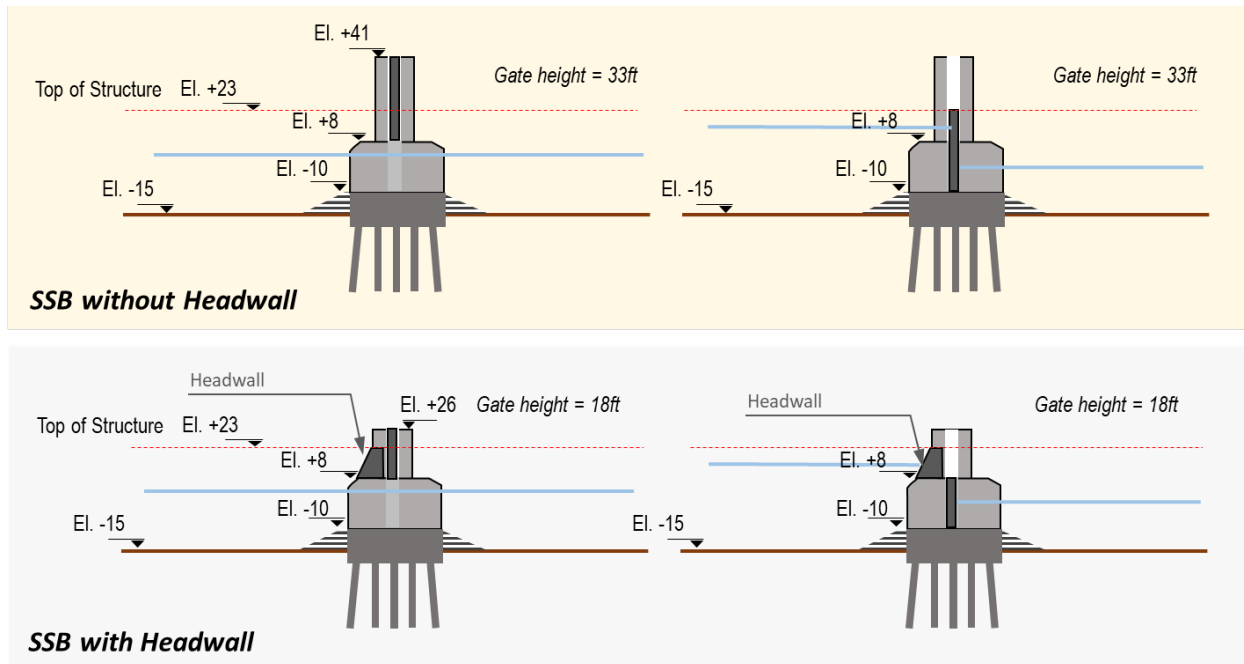

Figure 3-2:SSB Without Headwall (top panel) and SSB with Headwall (lower panel) Shown in Both Open (left) and Closed (right) Configuration

The auxiliary flow gate only passes flow and as such the gate does not need to be raised above the bottom of headwall elevation as stated in Section 2.7.12 The headwall spans between the elevation +8 feet and the top of the structure. While a headwall requires a fourth seal between structure and gate, since all four sides need to be sealed instead of three, the headwall reduces the overall height of the gates substantially⁷. For example, for the Verrazzano Narrows storm surge barrier, a gate height of 52 feet would be needed to close of an opening between a sill elevation of -30 feet to a design elevation of +22 feet, while with the use of a headwall the gate height would be 38 feet (sill elevation at -30 feet and top of gate at elevation +8 feet). A summary of the auxiliary flow gate dimensions is provided in Table 3-2 below.

Finally, the sill elevation of the auxiliary flow gates is to be above the existing bed elevation such that the potential for sedimentation or siltation at the bottom of the sill is minimized. Future data collection will be needed to obtain bathymetric profiles and additional analyses are needed to evaluate the effect the storm surge barrier has on the hydrodynamics and morphology of the estuarine system.

⁷ E.g., the Eastern Scheldt storm surge barrier (The Netherlands) includes a headwall type feature.

Table 3-2: Design Dimensions for the Auxiliary Flow Gates

Location	Existing Depth (ft)	Width of Flow Gate Opening (ft)	Depth of Flow Gate Opening (ft NAVD88)	Required Bottom of the Gate in Raised Position (ft NAVD88)
Verrazzano Narrows	Varying between 70 ft to 30 ft	150	-60, -25, and -20	+7

Following the specifications in Table 3-2 a suitable gate type has preliminarily been selected. Annex A provides a cursory review of the suitability of gate types for the auxiliary flow gates. Based on an evaluation the vertical lift gate is preliminarily selected for the auxiliary flow gates of the VN SSB.

3.5 General Project Phasing, Sequence of Construction, and Constructability Considerations

Project phasing considers the incremental completion of major systems, portions, and/or subsets of the overall project, and often considers the influence of construction activities upon factors external to construction itself, such as the accommodation of traffic through or around the construction site.

Sequence of construction considers the logical and orderly arrangement of construction activities to provide for an efficient completion of project construction. Sequence involves prescribing predecessor activities (those that must be undertaken and at least partially completed before subsequent construction occurs) and successor activities (those that must be delayed until such time at least a portion of the predecessor activity is complete). From the sequence, duration of activities, consideration of external influence, and interrelationship of predecessor and successor activities, a construction schedule is formulated.

The term “constructability”, in its most general sense, is defined as the ability of a structure to be constructed. For the purposes of this narrative, the term constructability also encompasses the location, extents, and physical and environmental conditions in which the project will be constructed. Constructability considers the nature of the work, contractor capabilities, equipment, and means and methods a given contractor might employ to accomplish the work. Constructability also considers site access, special material and work requirements, difficult or unusual environmental conditions, strict tolerances, complexities of mechanized and automated interfaces, exceptional loads and load handling requirements, risk, and many other specific impacts that the construction methods and processes.

Based on these general definitions, project phasing, sequence of construction, and constructability are all important considerations for the successful completion of the Verrazzano Narrows storm surge barrier. Key considerations include:

- Implementing project phasing to accommodate uninterrupted navigation access during construction

- Identifying a pool of qualified marine construction contractors that have the experience, equipment, and skill to undertake such a contract or series of contracts
- Identifying sources of materials of the required quantity and quality to fulfill project needs
- Identifying or establishing sources of specialized steel elements and assemblies, including but not limited to floating sector gate fabrications
- Accounting for the size, weight, and special load handling and transport requirements of portions of the Verrazzano Narrows gate assemblies
- Provision of utility services of the type and quantity required
- Configuring the facilities designs that are reliable, robust, and allow for effective operations
- Selecting materials and systems that are cost effective, durable, and easy to maintain or repair as necessary
- Configuring temporary facilities (e.g., cofferdams) such that risk for damage, overtopping, and recovery is properly mitigated

3.5.1 Project Phasing

A total of eight (8) primary phases of construction for Verrazzano Narrows. Generally, these phases are described as follows:

- 1) Preparatory Phase
- 2) Islands Construction
- 3) Floating Sector Gate Construction
- 4) Secondary Sector Gate Construction
- 5) Eastern Auxiliary Flow Gates
- 6) Western Auxiliary Flow Gates (Phase A)
- 7) Western Auxiliary Flow Gates (Phase B)
- 8) Western Auxiliary Flow Gates (Phase C)

Each of these phases involves numerous components of work, including construction of significant extents and quantities of foundations, earthwork, concrete, hydraulic steel structures, mechanical, electrical, and operating systems. Prior to initiation of subsequent phases, substantially completed facilities will need to undergo rigorous inspections, testing, and commissioning processes to ensure systems are ready to enter service.

3.5.2 Construction Sequence

The following describes the general phasing and construction sequence for the Verrazzano Narrows Storm Surge Barrier:

- Phase I – Preparatory Work
 - Mobilization
 - Establish staging and laydown area
 - Long-lead materials and fabrication orders
 - Temporarily relocate navigation channel by dredging westerly of the Phase I construction area (Phase I encompasses islands and structures easterly of the westernmost auxiliary flow structures)
 - Perform surveys and stakeouts (control, bathymetry, magnetometer, etc.)
 - Remove debris and abandoned siphons from structure footprint, as required, to avoid future obstructions during deep foundation installation
- Phase IIA – Floating Sector Gate Complex
 - Utilize floating equipment to install stone columns within future island footprint, to expedite consolidation of deep compressible materials.
 - Construct islands (at east and west floating sector gate locations) using competent granular materials. Incrementally construct island in lifts. Overfill to accommodate future subsidence and install instrumentation to monitor settlement.
 - As island fill is progressing, incrementally construct armor stone slope protection (revetment) around periphery of islands.
 - Monitor settlement, until magnitude of predicted future settlement is acceptable for installation of structures. Conduct geotechnical investigations to verify assumed strength gain due to consolidation in compressible strata.
 - Using islands as work platforms for equipment and material laydown, construct gravity-based and deep foundation structures within the island footprint. Many of these items can be constructed concurrently.
 - i. Incrementally remove revetment armor stone, provide templates, and construct permanent circular cells and interconnecting arcs on the gate side and harbor side of each island. Fill cells with competent granular material and provide ground improvement measures (e.g., vibro-compaction) within the cells. Construct cells to allow access for development of drydock closure gate.
 - ii. Upon cell completion, remove armor stone, underlayer, and fill outside the footprint of the completed cellular structures by excavation or dredging to required depth. Stone and other excavated materials to be beneficially reused at other locations. Dress armor stone to provide tie-in to cellular structures.
 - iii. Incrementally construct high-modulus anchored sheet pile wall system for dry dock (gate slot). Excavate dry dock, install anchor piles, and provide cast-in-place concrete base slab and drainage sump systems. Construct pump station.
 - iv. Construct pile-supported unloading platform(s), Ro-Ro facilities, on-site steel fabrication facilities, isolated chock foundations, and self-propelled

- modular transporter provisions associated with onsite ball joint, surge barrier, and truss arm construction.
- v. Construct permanent high-modulus sheet pile wall system cut-off structure at the periphery of the gate anchorage locations, to segregate gate anchorages from the channel, and temporary walls as excavation support for gate anchorage location.
 - vi. Provide drilled shafts for gate anchorage foundations. Construct concrete foundation cap for gate anchorage, including embedments for socket portion of ball and socket anchorage. Construct cellular concrete superstructure. Upon concrete achieving required strength, fill concrete superstructure with competent granular material. Provide compressible material within interstitial space between gate anchorage foundation and cut-off wall(s).
 - vii. Construct pile-supported concrete abutment, gate slot, sill, closures, and associated structures for dry dock roller gate.
 - viii. Construct deep foundation elements (as required) for support of control building(s), gate mechanical and operating systems, and other concentrated load locations.
 - ix. Complete tie-ins of cells, roller gate slot and abutment, gate anchorage foundations, and other features.
- Construct sill upon completion of the cell structures both sides of navigable opening.
 - x. Align and position prefabricated / precast concrete sill blocks.
 - xi. Place scour protection to “lock in” sill blocks
 - xii. Dredge sill recess.
 - Construct guide and guard (protection) cells at navigation approaches. Construct cell protection system (guide fender) on the channel side of the cells.
 - Place rip-rap mat outboard and inboard of sill within the navigable opening to the limits indicated.
 - Construct levee, floodwall, or other selected measure to raise crest elevation of island on surge side of gate to +20.0 (NAVD88).
 - Construct secondary concrete placements (e.g., pedestals) as required for gate accommodation within the drydock.
 - Remove cofferdam at dry dock, and flood dry dock for gate segment installation.
 - Construct drainage and stormwater management systems for the islands.
 - Provide cell and island pavements, and other surface finishes as required by O&M needs (e.g., crane platforms and pads).
 - Transport to the site and incrementally install prefabricated gate segments within dry dock.
 - Transport to site and install prefabricated ball joint/truss junction.

- Transport to the site and incrementally install prefabricated gate arm components. Provide balance of island pavements and surface finish tie-ins that were inaccessible during truss construction.
- Provide vertical construction elements and features, including operations building(s), maintenance facilities, access provisions, and other associated site accommodations.
- Provide, mechanical, electrical, lighting, operating, and control systems.
- Phase IIB – Secondary Sector Gate Complex
 - Continuing from permanent cell construction associated with the eastern cells of the eastern island, provide temporary circular cells and interconnecting arcs encircling secondary sector gate complex; this system will serve as the temporary cofferdam for the duration of construction.
 - Temporarily omit cells as required for barge-mounted equipment access.
 - Dredge to remove material to a depth required for tremie seal.
 - Install steel pipe portion of foundation elements (assumed to be driven steel piles and/or cast-in-place concrete piles with permanent steel casings) within the footprint for the sector gate and sill.
 - Complete cofferdam closure.
 - Place tremie seal within cofferdam footprint, dewater cofferdam.
 - Cut-off piles/casings to the required elevation. Auger to remove material within pile/casing as required and construct reinforced pile plugs and/or cast-in-place (CIP) concrete piles.
 - Construct sector gate abutments.
 - Construct abutment concrete pile caps.
 - Incrementally construct sector gate abutments in lifts, providing embeds and anchorages as construction progresses.
 - Incrementally construct tie-in (closure) structure between western sector gate abutment and eastern face of permanent cellular structure of the eastern island.
 - Incrementally construct trunnion assembly, including pin, bearing arm, bearing shoe, and post-tensioned anchorage.
 - Incrementally construct gate, including frames, intercostals, and skin plate. Construct stop gate system, to allow for maintenance dewatering of the gate pockets.
 - Construct sill across secondary navigation channel.
 - Construct roadway across gate abutments and gate framing for access to eastern island.
 - Construct fender system attached to exposed face of gate in the open position.
 - Provide mechanical, electrical, operating, and control systems.
 - When construction is sufficiently advanced, re-water cofferdam area, and incrementally remove cell fill, interconnecting arcs, and cell sheets.
 - Construct guide and guard (protection) cells at navigation approaches to secondary gate.

- Provide vertical construction elements and features, including operations building(s), access provisions, and other associated site accommodations.
- Provide, mechanical, electrical, lighting, operating, and control systems.
- Phase III – Relocate Navigation Channel
 - Upon completion of tests and commissioning, re-locate navigation channel(s) to align with navigable passages of completed structures (floating sector gate, secondary sector gate)
- Phase IV – VI Auxiliary Flow Gate Construction
 - At the VN SSB: West of the western artificial island: Implement ground-improvement measures if needed. The intent in this area is for concrete piles and concrete drilled shafts to be tipped in bedrock in order to control settlement. It is assumed that organic soils will be corrosive and that steel piles and steel drilled shaft casings west of the western artificial island will not be relied on in the long term.
 - Dredge surface to remove unsuitable material.
 - Place sand and gravel fill to form a sub-base for the concrete cofferdam seal.
 - Position templates for installation of the flat sheet piles of each cofferdam cell. Drive filled cellular-sheet-pile-cofferdam sheet piles sequentially. Fill each cofferdam cell with coarse sand and compact with vibratory probes. Connect round cofferdam cells with sheet pile arcs. Fill with coarse sand and compact with vibratory probes the arc cells.
 - Drive the temporary tension piles that will act as hold-down piles for the underwater seal outside of the footprint of the permanent structure. This step will include drilling rock sockets at the VN SSB. Note that this sequence implies that permanent piles, hold-down piles, and drilled shafts within the cofferdam will be installed using crawler or all-terrain cranes operating from the top of the cofferdam.
 - Drive the foundation piles (concrete piles at the VN SSB in the west narrows) and install the drilled shafts. This step will include drilling rock sockets at the VN SSB.
 - Drive the coated sheet pile cutoff walls
 - Place the underwater “tremie” concrete cofferdam seal.
 - Dewater the cofferdam.
 - Clean and roughen the exposed surface of the concrete which was placed under water.
 - Prepare pile butt connections. Weld headed studs onto sheet piles at sill/pile cap.
 - Install sill/pile cap reinforcement.
 - Subdivide the sill/pile cap and pour concrete for sill/pile cap in accordance with a planned sequence.
 - Roughen sill/pile cap concrete at any walls/piers.
 - Place rock fill on tremie seal to create fish ramp 1:5 slopes leading up to gate sills within the cofferdam.

- Form and pour any walls/piers.
- Install the headwall/inspection road girders.
- Flood cofferdam, excavate fill from coffer-cells and remove coffer-cell sheet piles.
- (At any adjacent sector gate: Install any approach wall piles now in order to avoid having to drive piles through any stone fill)
- Finish placing and grading stone slope protection outside of the stay-in-place underwater seal concrete apron including 1:5 fish ramps.
- Provide mechanical, electrical, lighting, heating, operating, and control systems. Install lift gate counterweights. Electrical and communications/control lines are expected to be routed through the headwall/roadway girders rather than below water. Final pier design will need to be coordinated with the allocation of space for mechanical systems, counterweights, stairs, and crew cabins if needed.
- Install the operable steel gates.

3.5.3 Constructability

The siting and eventual construction of a storm surge barrier is a complex undertaking, and practical constraints may influence the eventual design based on constructability considerations. Constructability will influence design considerations, structure type, project costs, phasing requirements, and schedule. Large civil works projects involving marine-based construction are represented by significant complexity and cost factors. These factors are generally exacerbated as water depth, flow velocities, and proximity to navigation channels are considered. Likewise, structure configurations used to overcome the spatial and loading criteria for which the structure must perform also heavily influence complexity and cost. Hence, basic constructability assessments must be performed to consider viability and provide for proof of concept for foundations and structure types under consideration. Constructability evaluations are an inherent part of any major civil works undertaking. Among the many considerations when considering constructability, the following should be considered:

- Maintenance of navigation and navigational impacts during construction
- General method of construction (e.g., in-the-dry, in-the-wet)
- Temporary works (e.g., cofferdams)
- Site access (e.g., barge-based work versus land-based access via temporary trestle)
- Site staging and laydown areas
- Material deliveries to the work site (e.g., floating concrete plant)
- Contractor capabilities, and the availability of both specialized contractors and equipment needed to perform the work
- Feasibility, availability, and locations of off-site fabrication areas for modular elements (e.g., float-in and lift-in elements)
- Variability of subsurface conditions, and methods used to address same to provide adequate foundations

- Impact from tides, current, weather, and other environmental factors on construction activities
- Extreme event scenarios, preparedness provisions, and similar risk considerations
- Potential availability of construction materials, including quality and quantity
- Waste and recycled materials considerations, including beneficial use
- Environmental considerations affecting construction activities (e.g., relocations, noise, work period restrictions)
- Construction schedule, including a variety of phasing and funding scenarios

3.6 Navigation Accommodation

The Verrazzano Narrows storm surge barrier is situated where the Hudson River transitions into Raritan Bay. The proposed storm surge barrier spans from Staten Island to Brooklyn, NY, just upriver from the Verrazzano-Narrows Bridge. The distance between the two shores is approximately 4,800 feet (0.9 miles). Water depths vary, with depths ranging from 30 feet to 50 feet outside the federal navigation channels, and depths exceeding 70 feet at certain locations within the channel.

The Verrazzano Narrows, between Staten Island and Brooklyn, is the principal entrance to the New York and New Jersey Harbor and is one of the busiest waterways in the United States. The proposed storm surge barrier crossing the Verrazzano Narrows intersect with Ambrose Channel Federal Navigation Channel; the Ambrose Channel at the proposed barrier is described as Reach D, with a length of approximately 2.9 miles, width of 2,000 feet, and minimum navigable depth of 53 feet at MLLW.

Cross-currents or excessive head-on and helping currents at the navigable passage could adversely impact navigation. The storm surge barrier and gate layout should be optimized to minimize adverse influence on vessels transiting the storm surge barrier. Additionally, the provision of aids-to-navigation, and protective structures at the navigable channel passage will increase navigational safety and potentially protect the storm surge barrier from aberrant vessel impact.

Temporary relocation of the Ambrose Channel will be required to allow for the phased construction of the Verrazzano Narrows storm surge barrier. Evaluation of the physical requirements and spatial extents of the barrier indicates that initial relocation of the channel westerly of the planned island complex would allow for navigation while providing mostly unencumbered access for construction of the islands and associated gate structures. Once the floating sector gate and secondary gate systems are operational, navigation would be relocated through the gate complex.

A schematic of the approximate location of the temporary channel relocation is provided as Figure 3-3.

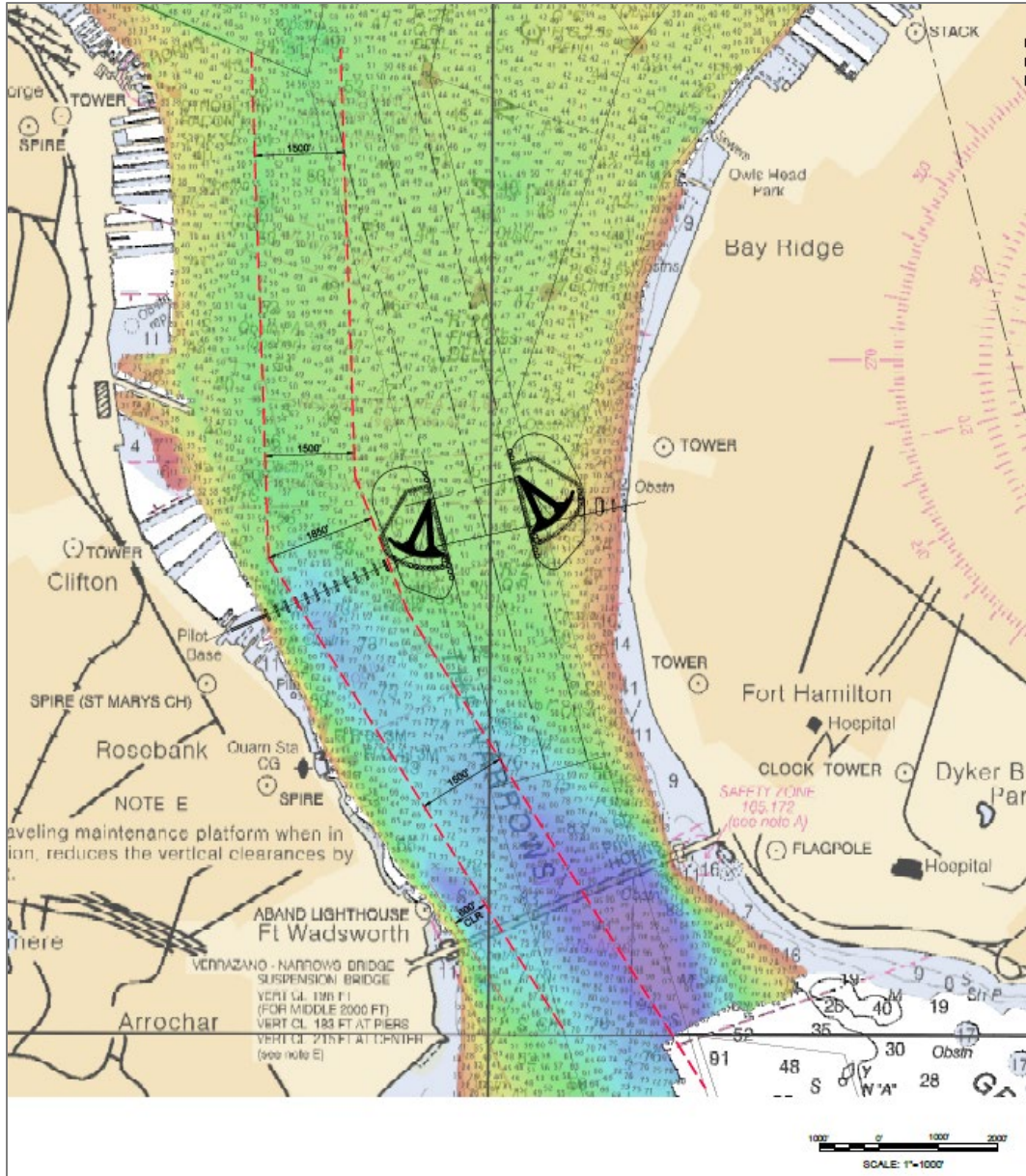

Figure 3-3: Schematic of Temporary Channel Relocation at Verrazzano Narrows SSB

The navigation scope for the project included the engagement of commercial vessel pilots (both Sandy Hook and Docking pilots) and other maritime interests (e.g., USCG, Port Authority, etc.). The general purpose of the navigation stakeholder engagement was to utilize the navigation community's expertise to identify potential fatal flaws with respect to the SSB concepts developed during the Interim Engineering Report.

The stakeholder engagement exercise consisted of four navigation stakeholder meetings held between November 2019 and February 2020. Discussions with the navigation community were aided by a detailed GIS environment encompassing the study area that included the following elements:

- Background aerial imagery
- Proposed SSB alignments
- Bathymetry
- Major NOAA navigational features
- Peak spatial currents at flood and ebb tide at each SSB location
- Spatial AIS vessel track data separated into vessel classes including (commercial, tanker, recreational, passenger)

During the meeting each of the SSBs was discussed in detail with the representatives from both the commercial and recreational navigation community, as well as the Coast Guard.

Table 3-3: Type of Traffic per SSB, According to AIS Information by Vessel Type

SSB	Cargo	Tanker	Tugs	Passenger	Pleasure Craft
JB	No	No	X	X	No
KVK	X	X	X	X	X ¹
AK	No	X	X	X	X ¹
VN	X	X	X	X	X
HR	No	No	No	No	No
TN	No	No	X	X	X
SH	X	X	X	X	X

Notes

¹ There is some pleasure craft traffic at KVK and AK. Data suggests that the volume is low and that AIS-transponder-equipped pleasure craft will refrain from transiting any KVK sector gate that is constructed.

With respect to the Verrazzano Narrows, the Interim Engineering Report presented an SSB just North of the Verrazzano Narrows Bridge with the following characteristics:

Table 3-4: Verrazzano Narrows SSB Characteristics

Navigable Pass	Design Ship Beam	Proposed Channel Width at Gate Location	Minimum Proposed Sill Depth	Air Clearance
Verrazzano Narrows Primary	59 m (21k TEU)	1,000-1,400 ft*	-55 ft	228 ft
VN Secondary	11 m	200 ft	-42 ft	228 ft

The proposed Verrazzano Narrows SSB crosses the main entrance to New York Harbor and would represent a major change in navigation risks in the area. Based on Automatic Identification System (AIS) data, high volumes of vessels of every type (cargo, tanker, tugboats, passenger, and pleasure) would pass through the 1,400-foot channel between the two artificial islands needed for sector gate leaf storage.

Input from the navigation stakeholders with respect to the proposed Verrazzano Narrows SSB follows:

- A preference was expressed for one of the alternative SSB systems that did not include a SSB at the Narrows, as the Narrows is an area of concentrated vessel activity.
- In general, the widths and depths of the proposed navigation gates were considered adequate.
 - The Verrazzano SSB should be moved south of the Verrazzano Narrows Bridge for the following reasons:
 - The location in the Interim Engineering Report intersects the primary anchorage area for the NY harbor making the anchorage generally unusable. The existing anchorage area is heavily utilized for making up barges and for various vessel safety procedures.
 - During flood tides, vessels would need to navigate through the gates at significant speed (at least 10 knots), and navigation representatives questioned their ability to properly slow down prior to making the turn into the KVK.
 - Navigation representatives also noted that due to the speed required to transit the gates, they would need to “commit themselves through the gates”, with no ability to emergency stop before the gates and little space to emergency stop after the gates.
- Fatal flaws with respect to navigation feasibility were not identified (see also Annex I).
- Other documented concerns included:
 - The visual obstructions the SSB would cause to navigation
 - The duration of time the “temporary” navigation channel that would need to be the main, authorized channel (multiple years during construction).
 - It was the preference of the recreational community to have two gates, one on each side of the main navigation gate, at each SSB location where considerable recreation traffic exists.

3.7 Preparatory Work

Preparatory work involves early project activities necessary for the contractor to plan, organize and assemble personnel and equipment, and otherwise establish facilities to undertake future work.

Mobilization comprises a significant portion of the preparatory work. Mobilization activities are generally considered to include the following:

- Initial movement of personnel and equipment to the project site;
- Establishment of the Contractor’s field offices, trailers, shops, and staging and laydown areas;
- Provision of sanitary facilities;
- Pre-construction photographs, surveys, utility locations, stake-outs, and other required site verifications;
- Provision of any required temporary site utilities;

- Provision of erosion and sediment control, turbidity curtains, and other water quality monitoring systems and environmental protection devices;
- The acquisition of all permitting not otherwise provided;
- The cost of required insurance, bonds and any other initial expense required for the start of work;
- All other features and facilities as may be required by any applicable local, state, and federal laws; and
- All other work and operations that must be performed prior to beginning work on compensable items.

Further preparatory work for in initial phases of Verrazzano Narrows include the following:

- Preparing shop drawings and other submittals, particularly those for long-lead materials and fabrication orders;
- Temporarily relocate navigation channel westerly of the Phase I construction area (Phase I encompasses islands and structures easterly of the westernmost auxiliary flow structures);
- Perform surveys and stakeouts (control, bathymetry, magnetometer, etc.); and
- Remove debris and abandoned siphons from structure footprint, as required, to avoid future obstructions during deep foundation installation.

3.8 Islands

Artificial islands form the foundational elements that support the floating sector gates. The islands are located each side of the future 1,400-foot-wide navigation channel that serves as passage through the storm surge barrier.

The artificial islands are configured with numerous earthen, foundation, and structural elements, which are described in the sections that follow.

3.8.1 Stone Columns

Stone columns are aggregate piers installed in a grid pattern into soft soils beneath a structure to strengthen the soils and to provide a drainage path, which will accelerate the consolidation of compressible soils. Installation of stone columns includes use of a vibrating probe to penetrate to the necessary depth and deposit gravel into the soils that require improvement.

Stone columns will be utilized at the Verrazzano Narrows. They will be constructed in-the-wet around the perimeter of the islands prior to placement of island fill to reinforce global stability of the side slopes. Throughout the interior of the islands, where fill will emerge above the waterline, stone columns will be installed in-the-dry following reclamation in order to densify the deep sand fill layer. Stone column preliminary design involves a 6-foot triangular grid, approximate 20% replacement ratio, installed to a depth of -143 feet NAVD88.

Stone columns would also be placed beneath the sill and 100-feet each side of the sill location, as a preemptive measure for settlement of the sill (area not initially surcharged by island fill).

3.8.2 Wick Drains

Wick drains are not used in preliminary design but could be contemplated in conjunction with vibro-compaction to supplement or replace a portion of the stone column installations within the interior of the island reclamation, where improved shear strength provided by stone columns in the alluvial stratum is not required.

3.8.3 Island Fill

After the initial installation of stone columns, fill material is to be placed underwater within the footprint of the islands until the top of the island is two (2) feet above MHHW. A retaining dike will be constructed around the perimeter prior to each lift of underwater fill. This stepped dike will minimize the quantity of dike material and permit faster placement of sand fill with minimal loss of material. Then, the backfill and compaction operation may commence on fast land. This will include fill material being placed in lifts and the installation of additional stone columns to densify the fill material previously placed in the water and accelerate settlement of the island.

Fill material should be free of debris, roots, scrap material, vegetation, refuse, soft unsound particles, and frozen, deleterious, or objectionable materials. Fill material considered is a granular soil with a maximum plasticity index of 10 and liquid limit of 35 in accordance with ASTM D 4318. Fill material will be placed in lifts and well compacted before placing an overlaying lift.

3.8.4 Surcharge and Settlement

Construction of the east and west islands involves placing 60+ feet of granular fill material over the existing riverbed which partially consists of compressible clay soils. The newly placed fill material causes the deeper clay layers to compress and reduce in volume resulting in the settlement of all soils above. Stone columns installed at 6-foot triangular spacing will accelerate the settlement process by providing pathways for water to escape the deeper clay layers.

Preliminary settlement analysis estimates 5 to 10 feet of settlement. Preliminary grade within the island fill will be EL +15 such that the target EL +10 on top of the island is roughly achieved following the surcharge hold period. Regrading and import of supplemental material are anticipated after the hold period.

3.9 Cofferdams and Other Temporary Construction Measures

Cofferdams and a variety of other temporary measures will be required to complete construction of the Verrazzano Narrows storm surge barrier complex.

It is anticipated that the secondary sector gate will be constructed using conventional (in-the-dry) construction techniques, within a dewatered cofferdam. The preliminary sequence of construction involves provision of a temporary cellular cofferdam structure around the periphery of the sector gate, initially leaving out one or two cells to allow for barge access. Within the partially completed cofferdam, dredging will occur to a depth required for the tremie-placed concrete seal. Foundations (pipe piles) will be placed, barge-mounted equipment removed, and the cofferdam completed with the remaining cells. With the cofferdam completed, dewatering can proceed, and the balance of

the sector gate construction completed in-the-dry. The temporary cofferdam will be removed upon completion of the secondary sector gate complex; the cell fill and sheet pile materials may be beneficially reused at other locations requiring temporary cofferdams.

Two additional temporary cofferdams are anticipated to be required at the channel end of each drydock that house the floating sector gates in their stowed position. Temporary cofferdams are necessary for construction of the drydock closure gate system. As indicated on drawing C-102, temporary cellular cofferdams are preliminarily selected for use.

The drydock closure gates are preliminarily configured as roller gates with a through-the-gate filling system to allow for flooding of the drydock chamber. The cofferdam will provide for in-the-dry construction of gate foundations, concrete sill and abutments, tie-ins to the drydock wall system, roller-gate construction, and the provision of operating machinery and control systems. The temporary cofferdam will be removed upon completion of the roller-gate systems; the cell fill and sheet pile materials may be beneficially reused at other locations requiring temporary cofferdams.

Construction phasing requires provision of a temporary wall support system external to the island, so that unimpeded construction of the floating sector gate foundation can occur. Preliminarily, this external wall support system is configured as brace (battered) steel piles, coupled with a horizontal wale system to distribute loads. As the floating sector gate foundation is completed, it is expected that the wall support system will be switched to an internal system, tying the combi-wall to the gate foundation with anchor (tie) rods, such as the gate foundation serves as the wall's permanent deadman anchorage. See drawing C-104 for this configuration.

Other temporary measures required for construction include excavation support systems, including temporary wall systems, shoring, anchoring, bracing, and trench boxes.

3.10 Retaining Structures

3.10.1 Cellular Structures (Permanent and Temporary)

Cellular structures are frequently used for port and harbor facilities, and for other large structures that involve heavy civil works, such as cofferdams, weirs, dams, and walls. Properly designed, cellular structures can support significant vertical and lateral loads, can be configured to retain fill, berth a variety of vessels, and accommodate the transfer of materials and equipment from vessels to land.

Sheet pile cellular retaining structures can be constructed both in-the-dry and in-the-wet, without prefabrication, in-place, using conventional equipment and construction techniques. Compared to other gravity-based options, such as precast caissons, cellular structures require relatively little foundation bed preparation, and readily conform to moderately variable subsurface conditions without the use of special features or techniques.

Among the several types of sheet pile cellular retaining structures, including circular cells, diaphragm cells, and cloverleaf cells, it appears that circular cells would be most applicable for the variety of permanent and temporary cellular structures at the Verrazzano Narrows site.

Circular cells consist of flat webbed hot-rolled steel sheet piling placed in a cylindrical configuration, represented by large circles in plan view. The equally spaced circular cells are connected with smaller semicircles of flat webbed sheet piling; the two shapes are connected by specially fabricated wyes, and typically intersect at either 30-, 35-, or 45-degree angles.



Both the fully circular cells and interconnecting arc areas are filled with granular material to complete the form of the gravity structure. Once the individual cells are filled, they are generally considered stable and can resist design-loading conditions.

The general methodology and sequence of construction for sheet pile cellular retaining structures is as follows:

- 1) Perform subgrade preparation, using dredging or general excavation methods, to remove loose, compressible, and otherwise unsuitable material from within the footprint of the cellular structure. Likewise, armor stone and similar heavy revetment materials that are not easily penetrated by the sheet piling must be removed. Material that is characterized as competent, such as the quarry run material used for island side slopes or sand for island fill, need not be removed provided that it remains fully consolidated and undisturbed. Removal of unsuitable and impenetrable material would most likely be done locally to each cell installation, as to maintain the integrity of the island fill.
- 2) Survey, position, and install sheet pile templates. Sheet pile templates are usually configured with structural steel framing, with spuds or pipe piles used to support its weight and maintain position during sheet pile installation. Templates are configured with a minimum of one level of bracing, although two- and three-level templates are far more common.



3) Sheet piling is provided, pre-prepared, with as-needed fabrications, driving shoes, and coatings pre-installed. With the template positioned and secured, individual flat-webbed sheets are lifted with a crane, and placed around the template, threading interlocks with the previously placed sheet. This process is repeated until the circle of sheets is complete, with all sheets extending an approximately equal distance above the template.



4) With sheets positioned around the template, individual sheets are incrementally lowered using a vibratory hammer to “drive” the sheets in position. Where necessary for the design, the sheets can be further driven and seated into the founding level (e.g., dense alluvium) using an impact hammer.



5) The template for the interconnecting arcs is positioned, set down, and the arc sheet piling installed in a manner similar to that of the circular cells.

6) Once the individual circular cell sheet piling is installed to the required elevation, the template is removed, and the cell is filled with granular material. Once both sides of the arc sheeting are complete, the area between the circular cells is ready for filling. Both operations can be done using conveyor, clamshell, or a variety of other bulk material handling equipment methods.



7) Depending on the design requirements and nature of the fill material, performance characteristics of the structure can be enhanced by way of fill consolidation within the cells. Vibro-compaction is one method that is commonly employed to consolidate material within the cells.



8) Once the cells are complete, they are ready to accept any of a number of additional structures and features necessary to support intended functions, including mooring

devices, breasting and fender systems, concrete caps, pavements, drainage features, and utilities. If desired, spread foundations, non-displacement piles (e.g., H-piles, steel pipe piles), and sheet piling may be installed within the cell fill, generally without effect to the overall structure.

- 9) Individual cells that are completed are inherently stable and can “winter over” construction seasons without ill effect. The cells can be constructed using land-based construction techniques, using an incremental process of cell construction, filling, and then using the previously completed cell as the work platform for the next cell installation. The ability to use land-based construction cranes to sequentially construct the cells eliminates the weather risk associated with typical barge-based marine construction.

3.10.2 Retaining Walls

The geometric requirements of the floating sector gate foundation/anchorage dictate that retaining structures other than circular cells be used where the gate foundation abuts the channel. Retaining structures are also required to establish the periphery of the floating sector gate drydocks. For the aforementioned wall locations, high-modulus sheet pile systems were selected as the retaining structures.

Alternative wall configurations were evaluated for each of the primary wall locations. Criteria evaluated for wall selection included geometric extents, height, geotechnical properties, applied surcharge, anchorage requirements, constructability, initial and maintenance costs, and temporary support systems and other measures needed to integrate the wall system into the completed structure.

Alternative wall systems include high modulus steel sheet pile bulkheads (e.g., combination pipe-Z section walls) with conventional deadman or soil/rock anchor system used for lateral restraint.

A pipe-zee wall configuration was assessed, which consists of structural z-shaped sheet piling interconnected with a row of pipe piles.

Wall alternatives include an HZ Wall option, consisting of interlocking HP-shapes and interconnecting steel sheet pile shapes. While this configuration may be a viable method that provides a workable anchored wall solution, the HZ wall type has lesser capacity than pipe-zee systems and would require a heavier built-up section. Hence, an HZ type wall system is not recommended.

3.10.3 Wall Anchorage

For the drydock, wall anchorage is needed to provide for lateral restraint. Two wall anchorage alternatives were evaluated for their efficiency and compatibility with site conditions:

- Sheet pile deadman
- Inclined pressure-injected grouted soil anchors (not shown)

A sheet pile deadman requires an offset secondary sheet pile wall, situated approximately 85-feet from the primary retaining wall. The deadman is connected to the wall with a series of

incrementally spaced horizontal steel tie rods. The location is based on affording adequate offset to avoid overlapping areas of influence between the respective soil masses. Providing sufficient offset between the walls ensures the passive resistance mobilized by the deadman wall will not load the active pressure area of the front cut-off wall. If the influence areas intersect, there is a corresponding reduction of anchorage capacity.

The offset distance of approximately 85-feet was found to be somewhat problematic for the surge-side deadman since the offset is directly beneath the floodside revetment. However, proper sequencing of construction can mitigate this issue, and both the conventional construction methods and ease of construction favor its selection.

Inclined pressure-injected grouted soil anchors were considered as an alternative to the conventional deadman anchorage system. The inclined soil anchors would be sleeved through a reinforced concrete cap that transfers loading to the cut-off wall system. Loading transfer to the cap is achieved by way of a positive bearing connection consisting of thick plate washers and heavy hex nuts. Plate washers are sized to provide sufficient distribution of compressive stresses corresponding to anchor tension. Soil anchor locations would be coincident with pipe pile locations to provide direct support of the downward anchor force component. The soil anchors would be installed by a specialized geotechnical contractor with regional experience from comparable project.

Preliminarily, it is expected that the anchors will consist of a fully encased and grouted 2.5-inch diameter high-strength steel bar. Anchor elements would be completely encased and grouted over the entire length for both corrosion protection and structural stability. Casing bores for the inclined anchors would be drilled through the oversized openings cast within the anchor cap, through the intermediate soil, and eventually into the underlying material below for development of ultimate capacity. Ultimate capacity of the soil anchors is developed by the bond stress formed between the pressure injected grout bulb and surrounding soil mass. The actual in-situ value of anchors capacity would be confirmed by an anchor-testing program during construction.

The corrosion protection system for the grouted soil anchors would be based upon recommendations of the Post-Tensioning Institute (PTI). The type of corrosion protection required will be determined in accordance with PTI DC35.1, Section 5.4. Since the anchors are permanent and critical to the performance of the structure, it is expected that the anchor system corrosion protection would be multi-component, Class II, Grout Protected Tendons.

Due to the relative complexity of grouted inclined anchors, the conventional sheet pile deadman and tie-rod anchor system was selected as the preferred wall anchor system for the floating sector gate drydock.

3.10.4 Corrosion Protection Systems

Steel piling structures, including exposed portions of permanent cellular and combi-wall retaining structures, require corrosion protection systems to provide for service life requirements.

A multi-system approach for addressing corrosion protection is assumed for this preliminary stage of design. Site-specific corrosion studies are required during detailed design to validate the

proposed corrosion mitigation, and those studies may result in alternative corrosion prevention requirements.

Externally exposed portions of retaining cells and walls will be provided with concrete encapsulation, from top of structure to 2 feet below MLLW.

Drydock wall systems and all other exposed and submerged steel will receive a high-quality, high-build coating system, such as a three-part epoxy polyamide system.

Submerged portions of exposed steel will receive a passive (sacrificial anode) cathodic protection system.

Reinforced concrete elements exposed to saltwater and saltwater splash will receive one or more systems of corrosion protection, including, but not limited to, increased bar cover (3" minimum), galvanized reinforcing steel, densified concrete (e.g., inclusion of pozzolans in the mix design), and other admixtures (e.g., calcium nitrite, anti-shrinkage) as determined by future corrosion studies.

3.11 Deep Foundations

The scale of the sector gate structures and the operational load demands necessitate the use of deep foundations to transfer loads from the gate down to stable soil or rock. Foundations for the gate anchorage that require embedment into bedrock utilize drilled shafts, which involves excavating a cylindrical area in the ground and then filling it with reinforced concrete. Steel piles are used to provide axial support for remaining components, such as the dry dock tie-downs and support for buildings and pump station.

3.11.1 Drilled Shafts

Support for the sector gate foundation is provided by a series of 15-foot diameter drilled shafts installed into the bedrock layer in a roughly triangular pattern to match the shape of the gate foundation. The top of the bedrock layer is estimated to be at elevation -250 feet NAVD with a shaft tip elevation of -280 feet NAVD, which represents a minimum of two shaft diameters of embedment into rock. The size and depth of the drilled shafts are primarily informed by two load cases: gate deployment and storm surge event.

During gate deployment, lateral load demands come from wind pressure and water current on the sector gate and truss arm. During a storm surge event, the lateral load demands come from hydrostatic and hydrodynamic thrust loads in addition to wind pressure on the structure. Both cases account for vertical load demands due to the weight of the sector gate components.

Due to the large overall diameter of the shafts, a 5-foot diameter void is cast into the center of the shafts to reduce thermal stresses that can occur during the curing of massive concrete structures. Steel reinforcing cages are placed in concentric circles with bundled bars to allow for tremie placement of concrete and to ensure that concrete can flow freely between the cages. Testing and installation verification methods, such as cross-sonic logging, will be considered in detailed design of the drilled shafts.

3.12 Floating Sector Gate

The floating sector gate system consists of two radial gates with associated anchorages, operating and control systems, with abutments and foundations to maintain position to allow for gate opening and closing while maintaining the line of protection against surge intrusion. The floating sector gates normally reside within the gate recess and are lowered onto the gate sill/threshold when deployed in the navigable channel.

The floating sector gates consist of:

- A pair of radial steel gates with buoyancy capabilities; the gates are fabricated with frames, intercostals, bracings, skin plates, and associated fabrications that make up the surge barrier at the navigable flood defense opening. In plan view, the gate is semi-circular, and if configured with a number of supports, openings, tanks, drive mechanisms, and associated equipment to provide for its intended function.
- A steel truss framework that interconnects and transfers hydraulic forces from the gate to the hinge location.
- A ball-and-socket joint that provides for articulation of the floating sector gate, and transfers forces to the deep foundation-supported gate anchorage.
- A drive mechanism on the upper edge of the steel gate front wall that is engaged by a mechanical drive system (drive cars) called locomobiles.
- Mechanically controlled gates, pumps, and valves for the intake and discharge of ballast water.
- Numerous other features and components to provide for inspection, access, instrumentation, and monitoring of systems.
- The radius of the floating sector gate, measured from the face of the gate to the centerline of the ball and socket is 962 feet. The height of the barrier, sill to crest, is approximately 77 feet. The length of each gate arch is approximately 1050 feet.
- The level of flood protection is to +19.0 NAVD88, with the gate sill provided at -58.0 NAVD88.
- The gate configuration is loaded with hydraulic forces in primarily a radial manner.
- This floating sector gate is compartmentalized with bulkheads, and contains a series of ballast tanks, each with inlet valves and deballast pumps; multiple (2 or more) units are provided for capacity and redundancy considerations.
- The gate arm trusses are made up of steel pipe fabrications arranged in a space frame system; four (4) 78-inch diameter by 2 ½-inch wall thickness steel pipes in a square pattern serve as the truss chords, while 24-inch diameter by ½-inch wall steel pipes serve as vertical, horizontal, and cross-brace web members. The trusses are tapered where they connect to both gate and ball and socket anchorage systems; the maximum depth of the truss is approximately 75 feet.

3.13 Gate Anchorage and Foundations

The concrete foundation supporting the sector gate arms is a roughly triangular-shaped concrete cap that is 265-foot-wide at the base. The foundations are positioned with 70 feet of soil between the back row of the drilled shafts and the edge of the island to provide lateral earth support for the gate foundation during deployment or a surge event.

The foundation is cast-in-place atop the drilled shafts discussed in Section 3.7.2. The thickness of the cap is sufficient to ensure that loads from the sector gate are transferred to the shafts and subsequently to the soils and bedrock. The thickness of the foundation varies from 24 feet at the minimum to 53 feet at the sector gate ball joint socket, and due to its large size must be poured in lifts and stages to manage thermal stresses and hydration cracking of the structure.

3.13.1 Dry Dock

An 85-foot-wide dry dock installed in both the east and west islands will house the sector gates while not in use. The bulkheads of the dry docks are pipe Z-type combi-walls with 48-inch diameter pipe piles that are 0.875-inches thick and AZ 28-700 intermediate sheet piles. The top of the dry dock bulkheads is at the typical island grade elevation of +10 feet, and the pipe pile tips are at elevation -112 feet, while the sheet pile tips are at -75 feet. The exposed height of the dry dock walls is 38 feet, which requires a tie-back system discussed further in Section 3.6.3 Wall Anchorage.

After the dry dock walls are installed, the soils between the walls are to be excavated down to elevation $-42 \pm$ feet. Then, steel HP 14x73 piles are to be installed in a 9-foot grid within the dry dock footprint with pile tips at elevation -153 feet, followed by a 10-foot-thick unreinforced concrete tremie seal that encapsulates the tops of the HP 14x73 piles. Once the tremie seal is set, the dry dock can be dewatered to allow for construction of a 4-foot-thick concrete slab with raised concrete pedestals to support the sector gate while stowed in the dry dock (see Figure 3-4).

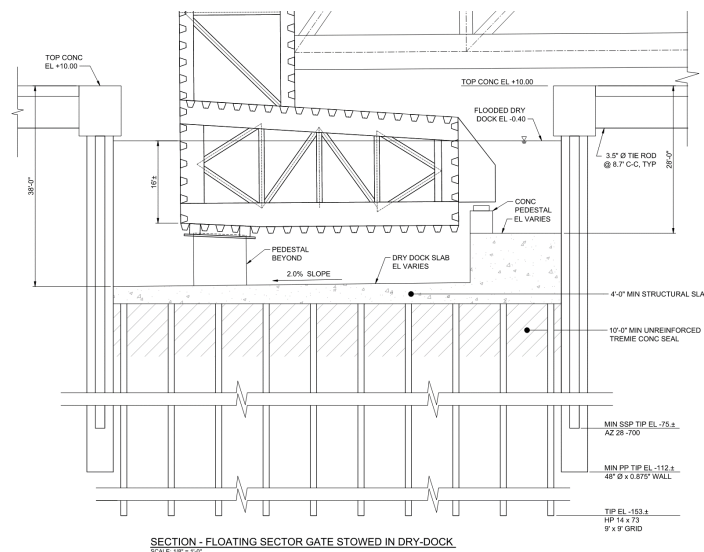

Figure 3-4: Floating Sector Gate Dry Dock

3.13.2 Gate Sill

A 70-foot-wide concrete gate sill installed across the bottom of the channel provides a relatively uniform bearing surface for the sector gates to rest when deployed (Figure 3-5). Construction of the sill begins with stone columns being installed within the footprint of the structure. The stone columns will serve to strengthen the soils they are installed into as well as mitigating consolidation of the soft soils beneath the concrete sill due to short-term loading from the gate structure.

After the stone columns are installed, bedding layers for the sill will be placed. The bedding consists of sand and crushed gravel layers. The 10-foot-thick precast concrete sill sections are then placed along the sector gate set-down area with the top of the sill at elevation -58 feet. Scour stone is then placed on both the flood and protected side of the sill (see section 3.15).

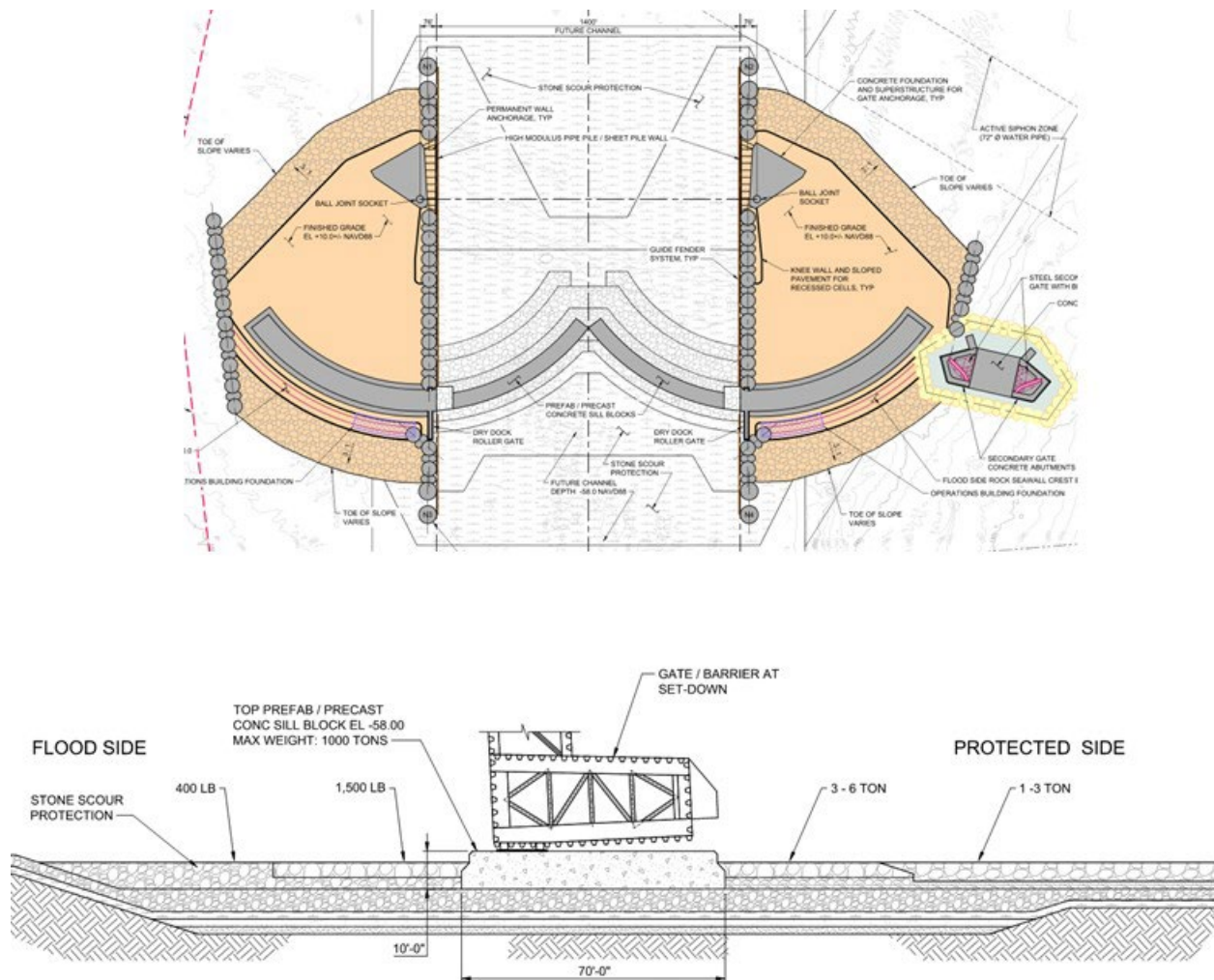

Figure 3-5: Floating Sector Gate Sill

3.14 Secondary Sector Gate

The Verrazzano Narrows SSB includes one conventional steel sector gate with a navigable opening of 200 feet located to the east of the larger 1,400-foot channel and floating sector gate structure.

3.14.1 Foundations

Once the temporary coffer cell system has been installed and the infill has been dredged to the elevation required for installing the tremie seal, the anchor steel pipe pile foundation required to overcome hydrostatic uplift forces associated with the dewatering process will be installed and cut to elevation. These foundation elements will also provide axial support required by the secondary sector gate complex. A series of 36" Ø x 3/4" steel pipe piles will be driven with pile tip and top of pile elevations of -175 feet NAVD and -45 feet NAVD, respectively. Piles are to be installed in a 9 feet x 9 feet grid pattern at the sector gate abutments and in a 10 feet x 15 feet grid pattern at the remaining tremie seal.

During gate deployment, lateral load demands come from wind pressure and water current on the secondary hydraulic gate and truss arm. During a storm surge event, the lateral load demands come from hydrostatic and hydrodynamic thrust loads in addition to wind pressure on the structure. Both cases account for vertical load demands due to the weight of the sector gate components.

3.14.2 Abutments and Gate Pockets

The east and west abutments each contain a recess for one sector gate segment, which in turn supports the access bridge. Since gate operating house, tower, transformer room, and other equipment requirements are not yet evaluated, it is assumed that these facilities and components would be integrated into the overall island complex facilities, i.e., equipment, operations, and control facilities for the secondary sector gate integrated with the eastern island facilities for the eastern island/floating sector gate complex. Hence, the secondary sector gate abutments make no provisions for buildings and other facilities within the abutments themselves.

The gate recess/pocket was made sufficiently large to accommodate the 125-foot sector gate. The top of the base slab in the recess will be at elevation -45.0 feet NAVD88; the pile-supported base slab (footing) is approximately 16 feet thick. Minimum thickness of concrete at the top of the structure is 21 feet, 4 inches. The south (surge) side and protected side walls were made 24 feet thick.

The north edge of the abutment containing the trunnion anchorages was turned at an angle of 30° so as to resist the direct thrust of the gate when fully loaded. It was found necessary to make this portion massive (33 feet, 4 inches wide by 64 feet long) due to the thrust from the gate.

The following conditions of loading were investigated for stability:

- Case I – Normal operating condition with all dead loads, tidal water at elev.+3.5 feet above MSL, and gate leaf in the recess.

- Case Ia – Same as Case I, plus 30 psf wind on the north side (most critical for wind).
- Case II – Full surge and maximum high water condition with still-water elevation at +14.6 NAVD88 and a maximum wave with crest elevation +33.1 NAVD88. Uplift over base varies from maximum still-water level on surge side to assumed protected side water elevation of -1.0 NAVD88 and wind on the exposed face of 30 psf.
- Case III – Same as Case Ia but with gate recess de-watered and stop gates in place.
- Case IV – Same as Case I but with earthquake loads applied from the north direction.
- Critical Conditions – Maximum bearing pressure occurred under maximum surge/hurricane loading, where it was found to be 7,300 lbs psf. Under normal loading, the maximum bearing pressure was 4,500 psf.
- Base Slab – The maximum loading on the base occurs under Case III loading. Slab was designed to span parallel with the main channel with a net loading equal to the uplift minus the weight of the slab.
- Side Walls – The vertical height of the abutment side walls is 64 feet, with lateral spans of approximately 101.6 feet, 117.7 feet, and 136.0 feet. Walls were evaluated as two-way slabs acting as a cantilever from the base and as a beam horizontally.
- Gate Sill – The gate sill extends across the bottom of the channel opening. The sill thickness is identical to the base slab/footing thickness for the abutments, at 16.0 feet. The sill is pile supported. It was analyzed with gate wheel loads applied. Because of the massiveness of the section, only nominal steel will be required. Expansion joints will be provided at the juncture of each abutment with contraction joints spaced at 30 feet maximum between them. PVC waterstops will be employed in all joints to eliminate leakage.

3.14.3 Sector Gate

The general dimensions of each of two units of the sector gate will be approximately 125 feet wide and 64 feet high, with an approximate weight of 750 tons each. The sector angle is 60 degrees and the radius of curvature is 120 feet, measured from the center of the trunnion to the outside face of the skin plate.

The length of the skin plate measured along the arc is approximately 126 feet. The component parts of each sector gate will be as follows: Skin plate and vertical tee supports; main horizontal built-up girders and vertical built-up girder struts; five horizontal trusses; five trunnion and anchorage assemblies; and four-wheel assemblies under the vertical girder struts to support the gate. To provide for dewatering of the gate pocket, vertical guide beams permanently attached to the gate will be provided to receive stoplogs (bulkheads) provided with rubber seals to ensure a watertight closure. Most connections will be accomplished by shop and field welding. No rubber seals will be provided for the gate leaves.

It is assumed that a barge-mounted crane would be used to place and remove the stoplogs; hence, there is no need for a demountable stiff-leg derrick. Fixed cast steel shoes for lifting will be provided on top of each sector gate.

Loading Conditions – Analysis of the sector gate and anchorages were based on the following loading conditions:

- Case I – Maximum surge (hurricane) condition with water at a still-water elevation of +14.6 NAVD88 using a maximum wave with crest elevation of +33.1 feet NAVD88 and water on the protected side assumed at elevation -1.0 NAVD88. Lateral pressures figured by the Sainflow Method and design stresses increased by 33 percent.
- Case II – Gate pocket dewatered with water on the surge side at elevation +7.0 feet NAVD88. Pressure on stop-gates is considered as straight hydrostatic loading and stresses increased 33 percent.

3.14.4 Sector Gate Materials

Gate framing structural steel: High-Strength Low-Alloy steel (50 ksi yield) for the sector gates and stoplogs.

Skin plate was designed to span continuously over the vertical tee intercostals, which are spaced approximately 21 feet center to center. The thickness of the skin plate was governed by the bi-axial shear stress resulting from the horizontal beam action of the skin plate itself and vertical beam action as the tension flange of the vertical intercostal.

The vertical tee intercostals to which the skin plate is attached are spaced on 2-foot centers and were designed to use the skin plate as an additional flange. These vertical intercostals bear on five horizontal built-up girders spaced approximately 14 feet on center with an approximate 4 foot cantilever at the top and a 4-foot cantilever at the bottom.

The reactions of the vertical intercostals are carried back to the trunnions through five rigid frames each consisting of a horizontal girder and rolled wide flange beams to form a closed truss. Connecting each horizontal truss to the trunnion assembly is a cast steel bearing arm that revolves on a steel pin. The diameter of this pin and of the bearing arm was governed by the allowable bearing stress on the bushing of the bearing arm.

The bracing between the five horizontal trusses making up the sector gate was kept to a minimum and so arranged as to make the structure determinate. The top 14 foot section of the sector gate consists of the two horizontal trusses, a vertical transverse truss and two vertical longitudinal trusses. The entire dead load of the gate is carried by these trusses. The reaction of the longitudinal trusses at one end will be carried entirely by the top trunnion and transferred into the abutment through a concrete haunch. At the other end, the reaction from the trusses will be carried by built-up vertical girders supported on wheels which ride on a rail at the base of the abutment. The trunnions of the other four horizontal trusses were designed to carry only the thrust from the surge/hurricane loads and the pull which occurs when the stop gates are in place and the gate pocket has been dewatered.

To provide for dewatering of the gate pocket, vertical guide beams permanently attached to the horizontal trusses are provided to receive stop gates. The load on the stop gate guide beams will be carried by the horizontal trusses and into the concrete abutment through a thrust girder set so

that the resultant pull on the trunnions will be at the same angle as the thrust resulting from surge/hurricane loading when the gates are in the closed position.

The forged steel pins carrying the load from the gate to the anchorage assembly was designed as described in the preceding paragraph and then was checked for shear and bending moment.

The net section of the bearing arm was designed as a tension member for 140 percent of the load resulting from Case II loading.

The pin plates of the bearing shoes were designed to take the thrust transmitted by the pin and for 140 percent of the tension load resulting from Case II loading. The base of the shoe will be designed for bending.

The post tensioned anchorage assembly was designed for the tension load resulting from Case II loading. This tension load will be transmitted to the post-tensioned anchor beams by anchor bolts connecting the anchor beams to the bearing shoe. No increase in allowable stresses was made for the post-tensioning rods or the concrete.

In order to protect the structural steel of the gate against damage from the possible impact of a vessel, wood fenders will be provided. The fenders will be 8" x 12" in size spaced approximately 2'-0" center to center, between elevation -10.0 NAVD88 and +10.0 NAVD88.

3.14.5 Access Bridge

Due to the need for inspection vehicle (snooper truck) access, the secondary sector gates will be designed and configured with vehicle access bridge segments on top of the gate.

Preliminarily, the gates are steel framed with an open steel grate travel surface. Fabricated steel sections will be used for vehicular and pedestrian barriers on each side of the bridge.

The bridge geometry is slightly serpentine to allow for required clearances when the gate segments are in the stowed position. When the gates are deployed (gates closed), the bridge segments meet at the centerline of the navigation passage, with a geometric configuration that allows access from lift gate headwall, to sector gate abutment, to access bridge, and so on.

3.14.6 Other Secondary Sector Gate Features

Other secondary sector gate features include:

- Control Building
- Maintenance Shop
- Control Systems Housings
- Inspection and Personnel Access Provisions
- Instrumentation
- Guard and Guide structures to prevent aberrant vessel collision.

3.15 Scour Protection

3.15.1 Bed Protection for Floating Sector Gate

Bed protection for the floating sector gate is governed by flow velocities during the closure procedure and/or by extreme velocities that may occur under direct head conditions. Water flow will occur underneath the floating sector gates, along the sides of the gates (at the dock location). In addition, the bed protection at Maeslant consists of a granular closed filter and flow will also occur through the filter. The Maeslant SSB bed protection design relied heavily on physical model scale tests, and since no detailed information on flow velocities during the closure process can reasonably be estimated for VN, a site adaptation is proposed. A similar design is used, but the extent of the bed protection is scaled to the channel dimensions at VN. The gate is positioned on prefabricated concrete sill blocks and bottom protection extends upstream and downstream along the navigable opening beyond the island footprints.

The layer thickness was generally selected to two (2) stones. However, for large stone sizes, the layer thickness was reduced to one stone. A layer thickness of at least 0.5 m is recommended in CEM, VI-5-142. Due to the criticality of the structure, practical limitations of placing materials at these depths and to include some conservatism into the design at feasibility stage, a minimum layer thickness of 3 ft was selected (including sand and gravel layers). A diagram of the varying stone layers is provided in the image below and is included in the VN Plan Set (see Annex G).

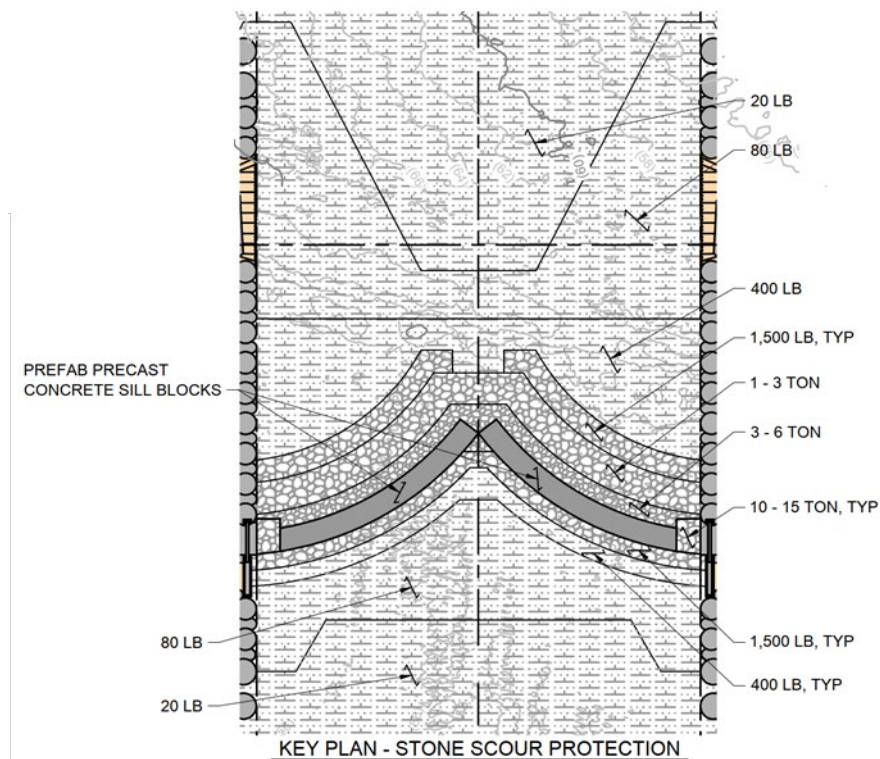

Figure 3-6: Diagram of Scour Protection for the Floating Sector Gate

3.15.2 Lift Gate

SSBs with a limited number of gate openings will constrict flow through this part of the Narrows. Scour aprons upstream and downstream of the lift gates are planned, with the objective of protecting the toe of structures against undermining caused by the increase in flow velocity through the harbor resulting from the reduction of flow area along the barrier alignment (long-term scour), and also for intensified scour during gate closure and opening (transient or short-term scour).

The scour apron for the vertical lift gates of the Verrazzano Narrows SSB is composed of a 165-foot wide bed of quarry-run stone, both upstream and downstream of the structure, three to four feet thick, placed over a geotextile layer. For the 30 feet next to the sill, the quarry-run bed will be placed 7'-3" below the bottom-of-sill elevation, where the 7'-3" of depth will be filled with a double layer of stones of heavy grading. For details of the apron, please refer to Annex G, which contains the plan set for this SSB, including drawings of the typical cross section of the apron.

3.16 Lift Gate

In addition to floating and conventional sector gates, the Verrazzano Narrows SSB includes 15 auxiliary vertical lift gates (VLGs). Each gate is 150 feet wide with horizontal bowstring arch trusses assembled from steel members having pipe and round HSS cross-sections (see Figure 3-7). The VLGs are slotted into vertical recesses in concrete piers. Each pier typically has a recess on two opposing faces and serves as the lateral support of a pair of gates. Each pier is provided with a concrete tower. Each tower has a machinery room on top, housing the hoisting gear – again, typically for two gates. Gates will likely be raised using winches and bull gears, possibly augmented with counterweights. When lowered, the bottom of each gate seals against a concrete sill. Top-of-sill elevation varies from elevation -25 to -62 feet NAVD88 at this SSB.

Spanning from pier to pier across each gate opening, at the top of each gate is a concrete headwall, which provides protection against flooding from the top of the gate to elevation +19.0 feet NAVD88. The bottom of the headwall girder is at El. +8.0 feet NAVD88. This headwall also provides a one-way road bridge for inspection and light maintenance, 12 feet wide, at elevation +19.0 feet. The access road was designed to carry an under-bridge inspection vehicle; public access will not be permitted.

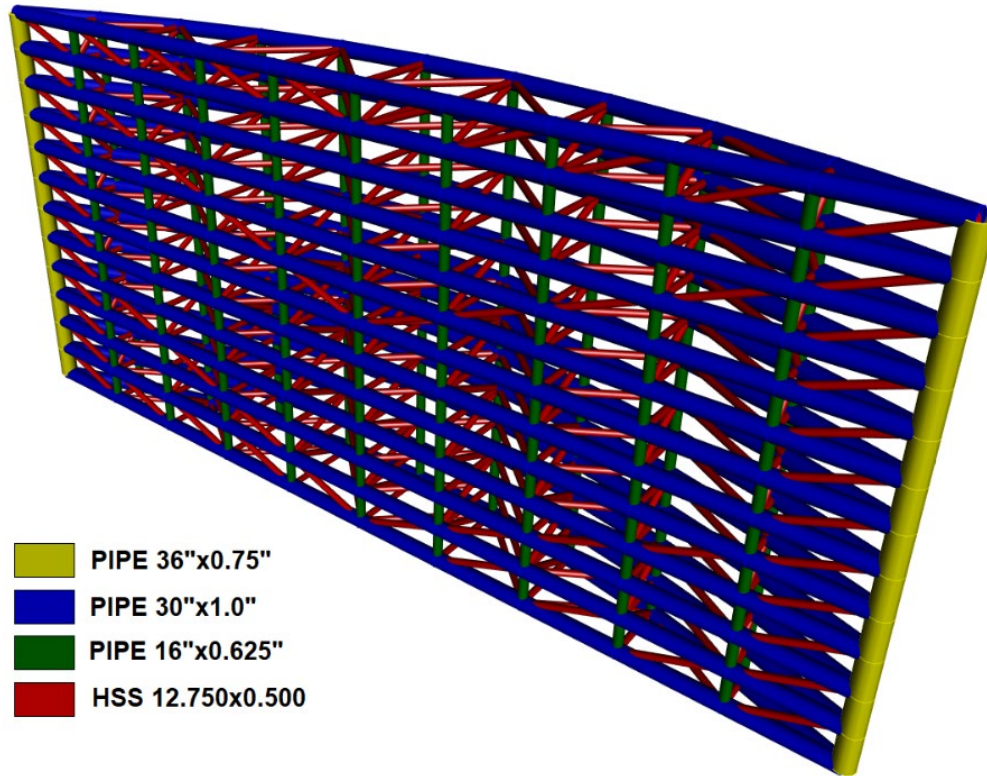

Figure 3-7: A Vertical Lift Gate at Verrazzano Narrows – Isometric View

Lift gate openings are not intended for commercial navigation; for this reason, the lift gates are also referenced as “auxiliary gates”. They allow the flow of water, sediment, and fish through the storm surge barrier during normal conditions. This reduces the environmental impact of the SSB. The greater the number, sill depth, and width of open lift gates, the lesser the magnification of current velocities as a result of reducing the cross-section of the natural waterway at the SSB. Controlling current makes navigation less risky across the SSB.

The preliminary design of the lift gates at this SSB was based on existing structures, ETL 1110-2-584, EM 1110-2-2610, and the operation conditions expected at this location. For more details regarding the design, please refer to Annex G, which contains the plan set.

3.17 Dam Sections and Tie-ins

For Verrazzano Narrows, the dam sections and tie-ins are configured as circular sheet pile cells with interconnecting arcs. Cells will be excavated to remove highly compressible and other weak materials and will then be filled with well-drained granular fill. Dam sections and tie-ins transition between the landward-most pier(s) of the vertical lift gates and the shore-based measures at both Brooklyn and Staten Island.

For durability and corrosion protection the cellular structures are expected to receive a reinforced concrete facing and top slab encapsulation; this will also serve to prevent the loss of fill material due to erosive forces. Coatings and/or cathodic protection systems will afford additional corrosion protection below the inter-tidal zone.

3.18 Siting Considerations

The Verrazzano Narrows SSB design has been prepared to allow for a Class 4 cost estimate. As noted earlier, no siting study had been completed for any of the SSBs under the NYNJHAT Study. During earlier stakeholder engagement, there was some concern with the proposed location which is documented in Annex I. Comments from commercial and recreational pilots included concerns related to:

- 1) temporary navigation channels during construction,
- 2) approaches to navigable gates in the permanent channels, and
- 3) conflicts with designated anchorage areas.

Given the comments from the navigation stakeholder group and the costs associated with underwater rock excavation, additional alternative alignments were proposed and examined at a very high level for the AK, KVK, and VN SSBs in early 2022. Potential changes identified for VN included a shift of the structure to a location south of the Verrazzano Narrows Bridge. High-level cost estimates were prepared to understand the magnitude of the cost differential if such a change would be incorporated into the alternative at a later date. More details are available in the Cost Engineering Appendix.

3.19 Synopsis

This section includes the description of the conceptual design development of the Verrazzano SSB. The design elements, description of the elements, and preliminary developed construction sequence have been used to develop a Class 4 cost estimate (see the Cost Engineering Appendix). Feasibility-level design drawings and a proposed sequence of construction for the Verrazzano Narrows SSB are provided in Annex G.

4 Jamaica Bay Storm Surge Barrier

4.1 Location of Jamaica Bay SSB

The Jamaica Bay storm surge barrier is located where Rockaway Inlet enters Jamaica Bay. The proposed storm surge barrier would span the entrance to Jamaica Bay, from Barren Island, NY, to Rockaway, NY, in the vicinity of the Gil Hodges Bridge, as shown in Figure 4-1. At this location, the distance between land masses is approximately 3,500 feet (0.65 miles). Water depths vary from 20 feet to 40 feet. A cross-section is provided in TSP Plan Set Sub-Appendix.

The preliminary location of the Jamaica Bay storm surge barrier has been informed by previous analysis completed by USACE-NAN, where the storm surge barrier location matches the preferred alternative from (USACE, 2016). It is further noted that this proposed alignment also corresponds approximately to the alignments for Barrier Plans A, B, C-1, C-2, and C-3 investigated in the previous 1976 USACE-WES studies (USACE-WES, 1976).

It is assumed that previous analyses and evaluations provide sufficient basis to site the storm surge barrier at this location and, as such, eliminates the need to revisit such analyses. The storm surge barrier is preliminarily sited along the transect shown in Figure 4-1.

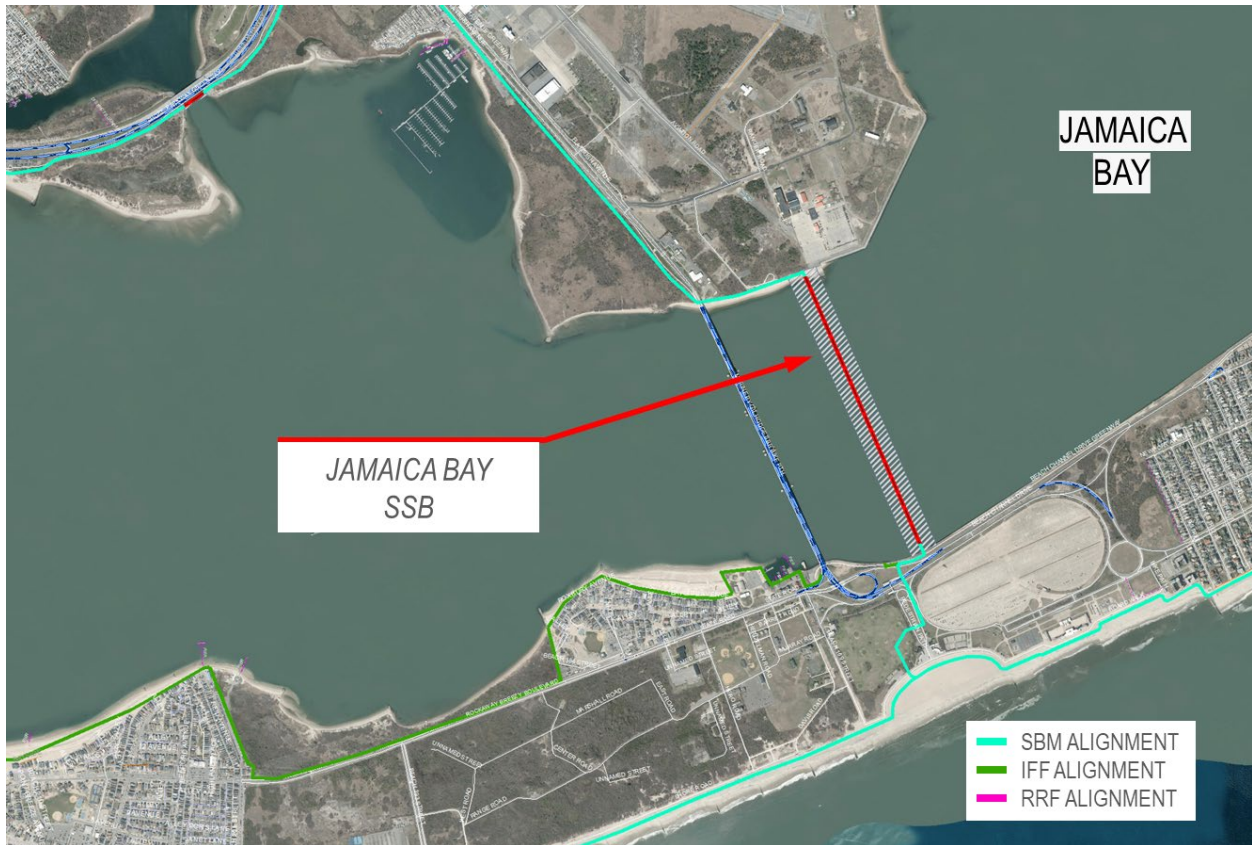

Figure 4-1: Area of Interest for Jamaica Bay Storm Surge Barrier

4.2 Dimensions of the Navigable Passages

The design development of the minimum practical dimensions of the navigable passages of the storm surge barriers follows from the navigation assessment as presented in Annex A. The design vessel specifications and channel dimensions were established following PIANC guidance. Annex A details the maritime traffic study and required minimum geometry for the navigable passages. The following sections provide a brief synopsis of the conceptual design development for the navigable passages.

4.2.1 Navigable Passage Dimensions – Jamaica Bay

The storm surge barrier from Barren Island, NY, to Rockaway, NY, will have one opening to allow for maritime traffic to traverse:

1. Rockaway Inlet Navigable Passages Openings: 200 feet wide
 - PIANC guidance to set navigational opening: minimum 198 feet
 - Set sill at a minimum at -22 feet MLLW. The Authorized Channel Depth is -18 feet MLLW and a 2-foot clearance is included to account for the hard-bottom structure, and an additional 2 feet is included to increase flow conveyance. -22 feet MLLW equals -25 feet NAVD88
 - Air draft is controlled by the Gil Hodges Bridge at 152 feet. This clearance is adopted as a conservative assumption, which, in practicality for the design of storm surge barriers, translates to unrestricted air clearance.

Table 4-1: Minimum Practical Dimensions for the Navigable Passages of the Jamaica Bay SSB

Location	Federal Channel	Existing Depth (ft)	Minimum Practical Width of Opening (ft)	Authorized Channel Depth (ft NAVD88)	Minimum Depth of Opening (ft NAVD88)	Air Clearance (ft NAVD88)
Jamaica Bay	Rockaway Inlet	20-30	200 ¹	-21	-25	Unrestricted

Notes:

¹ Practical width of navigable passage based on one-way traffic

4.3 Navigable Gate Type Selection

Following the minimum design dimensions outlined in Table 4-1, a suitable gate type has been selected. Annex A includes an overview of the supplemental data from Mooyaart and Jonkman (2017), which provides an overview of characteristics of constructed storm surge barriers. In addition, Annex A includes an overview of hydraulic gate types used in navigable storm surge barriers and lists general advantages and disadvantages of each gate type. Using the data set and

the listed advantages and disadvantages, this appendix provides a cursory review of the suitability of each gate type for the navigable passage. Based on the evaluation that is provided in Annex A, sector gates (vertical axis) are preliminarily selected for the conceptual design of the navigable passages.

4.4 Auxiliary Flow Gates

Design considerations for the selection of auxiliary flow gates are described in Section 3.4 and are based on the review of gate characteristics as presented by Mooyaart & Jonkman, 2017, and on Annex A. Headwall elevations are set for Jamaica Bay accordingly to Table 4-2 below.

Table 4-2: Design Dimensions for the Auxiliary Flow Gates

Location	Existing Depth (ft)	Width of Flow Gate Opening (ft)	Depth of Flow Gate Opening (ft NAVD88)	Required Bottom of the Gate in Raised Position (ft NAVD88)
Jamaica Bay	Varying between 300 ft to 20 ft	150	varying	+7

The existing cross-sectional flow area at the proposed storm surge barrier location is approximately 108,000 ft². The aggregated flow opening area provided within the conceptual design is 61,700 ft² (approximately 57% of the existing flow area at that location).

4.5 General Phasing, Sequence, and Constructability

General phasing and sequence of construction for the Jamaica Bay SSB are largely dictated by maintaining both hydraulic flow and navigation during construction activities.

The Jamaica Bay Storm Surge Barrier (JB SSB) is composed of two (2) Sector Gates, fourteen (14) Vertical Lift Gates with piers (sixteen total), and two dam sections at the north and south ends of the barrier alignment. The proposed structures are located approximately ¼ mile easterly of the Marine Parkway (Gil Hodges) Bridge. The Line of Protection for this barrier extends through Rockaway Inlet/Jamaica Bay approximately 4,100 feet from north to south, with the top of barrier situated at +18.0 NAVD88.

The proposed construction of the JB SSB barrier will be divided into four primary stages:

- The first construction stage involves preparatory work, and the construction of the southerly sector gate and associated abutment monoliths. This requires the provision of a temporary cofferdam that encompasses the area of the gate construction. It is expected that a land-based staging and laydown area will be established, with personnel, equipment, and materials shuttled between the staging area and the work site. Navigation will be afforded access around the work site at a location just to the north of the cofferdam.
- The second stage of construction involves Stage 1 cofferdam removal, and installation of the temporary cofferdam at the second (northerly) sector gate location. Navigation traffic is expected to be one-way through the newly constructed navigable gated passage. Upon

completion of construction and commissioning of the two sector gates, navigation will be dedicated to one-way traffic through each gated opening.

- The third and fourth stages of construction involve the construction of dam sections, piers, and vertical lift gates north and south of the sector gate.

The first and second stages of construction involve the following general construction sequences:

- 1) Provide temporary circular cells and interconnecting arcs encircling secondary sector gate complex; this system will serve as the temporary cofferdam for the duration of construction.
- 2) Temporarily omit cells as required for barge-mounted equipment access.
- 3) Dredge to remove material to a depth required for tremie seal.
- 4) Install steel pipe portion of foundation elements (assumed to be driven steel pipe piles) within the footprint for the sector gate and sill.
- 5) Complete cofferdam closure.
- 6) Place tremie seal within cofferdam footprint, dewater cofferdam.
- 7) Cut-off piles/casings to the required elevation. Auger to remove material within pile/casing as required and construct reinforced pile plugs and/or CIP concrete piles.
- 8) Incrementally construct sector gate abutment monoliths in lifts, providing embeds and anchorages as construction progresses.
- 9) Incrementally construct trunnion assembly, including pin, bearing arm, bearing shoe, and post-tensioned anchorage.
- 10) Incrementally construct gate, including frames, intercostals, and skin plate. Construct stop gate system to allow for maintenance dewatering of the gate pockets.
- 11) Construct sill across navigation channel.
- 12) Construct roadway across gate abutments and gate framing.
- 13) Construct fender system attached to exposed face of gate in the open position.
- 14) Provide mechanical, electrical, operating, and control systems.
- 15) When construction is sufficiently advanced, re-water cofferdam area and incrementally remove cell fill, interconnecting arcs, and cell sheets. Re-use and relocate sheeting for second stage (northerly sector gate complex) for lift gate cofferdams or for use as the dam sections and landside tie-ins.
- 16) Construct guide and guard (protection) cells at navigation approaches to secondary gate.
- 17) Provide vertical construction elements and features, including operations building(s), access provisions, and other associated site accommodations.

18) Provide mechanical, electrical, lighting, operating, and control systems.

For the third and fourth stages listed above, the use of cofferdams during construction is assumed. The construction sequence for these stages will be the following:

- 1) Excavate if needed and place sand and gravel fill to form a sub-base for the tremie seal of the cofferdam.
- 2) Drive pipe piles and install drilled shafts.
- 3) Install sealant in sheet pile interlocks, drive the coated sheet piles, and install cofferdam bracing and king piles.
- 4) Place the underwater tremie concrete seal for the cofferdam. Dewater the cofferdam. Use barges as camels to prevent vessel impacts.
- 5) Clean and roughen the exposed surface of the concrete which was placed under water.
- 6) Prepare pile connections and weld headed studs onto sheet piles at sill/pile cap.
- 7) Install sill/pile cap reinforcement.
- 8) Pour concrete for sill/pile cap.
- 9) Roughen sill/pile cap concrete at any walls/piers.
- 10) Place rock fill to create slopes leading to gate sills where needed.
- 11) Form and pour any walls/piers.
- 12) Install the headwall/inspection road girders.
- 13) Flood the cofferdam.
- 14) Cut off cofferdam sheet piles flush with top of sill/pile cap.
- 15) Install the steel gates.

For more details, please refer to the TSP Plan Set Sub-Appendix with the plan set for the JB SSB.

4.6 Navigation Accommodation

Using the data provided (and based on USACE 2016), it is expected that the majority of the commercial traffic is barge traffic with a vessel beam of 50 feet. It is noted that there is a significant portion of recreational traffic within this area (there are over 50 private marinas located around Jamaica Bay providing boat slips and launch ramps – NYC Department of Environmental Protection Jamaica Bay Watershed protection plan). The estimate for the navigable passage width is set 200 feet for this location. This estimate is based on the preliminary design provided in USACE 2016. It is further assumed that a 200-foot navigable opening will be able to accommodate safe passage of vessels; it is equal to the width of the Rockaway Inlet navigable passage and would thereby accommodate all traffic coming through that reach.

Navigation accommodation during construction involves a phased construction approach, with sequential construction of the two sector gate complexes. The presence of the cofferdams will constrict the width of the navigation channel, which will require the provision of aids-to-navigation and could require the implementation of one-way vessel transits through the construction zone. Traffic volumes with one-way traffic are not expected to cause undue congestion, and it appears unnecessary to provide alternate bypass channels around the construction zone. It may be desirable to enlarge and realign the existing navigation channel, as the width of the two adjacent sector gate complexes exceeds the width of the existing channel; channel enlargement and realignment could be considered in concert with the future replacement of the Gil Hodges Bridge.

The Jamaica Bay SSB will represent a major change in navigation risks in the area. Based on AIS traffic data, high volumes of passenger vessels and tugboats (including towed barges) will pass through the 200-foot-wide sector gate openings.

The Interim Engineering Report presented an SSB, just east of the Gil Hodges Bridge, with the following characteristics:

Table 4-3: Jamaica Bay SSB Characteristics

Navigable Pass	Design Ship Beam	Proposed Channel Width at Gate Location	Minimum Proposed Sill Depth	Air Clearance
Jamaica Bay	N/A**	200 ft*	-22 ft	152 ft

*Authorized channel is wider

** Not available in the Interim Report

In February 2020, commercial navigation stakeholders recommended that the Jamaica Bay SSB gate be better aligned with the Gil Hodges Bridge abutments and that the SSB be relocated farther to the east in order to provide a minimum half-mile spacing between the gates and the Gil Hodges Bridge for the following reasons:

- Vessels will be set when going through the gates and will need the appropriate time to correct and line up to go through the oncoming bridge abutments. The recommended distance was based upon an assumed speed of 2-3 knots (barge traffic) resulting in 10 min between the gate and the bridge.

Input from the navigation stakeholders participating in the navigation stakeholder meetings previously described with respect to the proposed Jamaica Bay SSB included the following:

- In general, the widths and depths of the proposed navigation gates were considered adequate.
- Fatal flaws with respect to navigation feasibility were not identified.

4.7 Preparatory Needs

Preparatory work involves early project activities necessary for the contractor to plan, organize, and assemble personnel and equipment, and otherwise establish facilities to undertake future work.

Mobilization comprises a significant portion of the preparatory work. Mobilization activities are generally considered to include the following:

- Initial movement of personnel and equipment to the project site;
- Establishment of the Contractor's field offices, trailers, shops, and staging and laydown areas;
- Provision of sanitary facilities;
- Pre-construction photographs, surveys, utility locations, stakeouts, and other required site verifications;
- Provision of any required temporary site utilities;
- Provision of erosion and sediment control, turbidity curtains, and other water quality monitoring systems and environmental-protection devices;
- The acquisition of all permitting not otherwise provided;
- The cost of required insurance, bonds, and any other initial expense required for the start of work;
- All other features and facilities as may be required by any applicable local, state, and federal laws; and
- All other work and operations that must be performed prior to beginning work on compensable items.

Further preparatory work during initial phases of Jamaica Bay include the following:

- Preparing shop drawings and other submittals, particularly those for long-lead materials and fabrication orders;
- Perform surveys and stakeouts (control, bathymetry, magnetometer, etc.); and
- Remove debris from structure footprint, as required, to avoid future obstructions during deep foundation installation.

4.8 Sector Gates

The Jamaica Bay SSB includes two conventional steel sector gates, each with navigable openings of 200 feet. These gates are similar to (and derived from) the recreational secondary sector gate considered at Verrazzano Narrows.

4.8.1 Foundations

Foundations will be constructed in a similar manner to Verrazzano Narrows with a series of 30"Ø steel pipe piles driven with pile tip elevations of -132 feet NAVD88 and top of pile elevations of -25 feet NAVD88.

4.8.2 Abutments and Gate Pockets

For each gate, the north and south abutments each contain a recess for one sector gate segment, which in turn supports the access bridge. The concrete abutments at the center of the two gates between navigation channels will be structurally connected. during construction of the northern

abutment in Phase II. The sector gate abutments make no provisions for buildings and other facilities within the abutments themselves; however, the center abutment provides adequate space to incorporate components that would be integrated into the overall SSB facilities, i.e., equipment, operations, and control facilities for the sector gates.

Plan dimensions and functionality for each abutment are similar to that of Verrazzano Narrows. The top of the base slab in the recess will be at elevation -25.0 feet NAVD88 due to the shallower channel depths at Jamaica Bay and the top of abutment elevation.

The following conditions of loading were investigated for stability:

- Case I – Normal operating condition with all dead loads, tidal water at elev. +3.5 feet above MSL, and gate leaf in the recess.
- Case Ia – Same as Case I, plus 30 psf wind.
- Case II – Full surge and maximum high-water condition with still water elevation at +14.5 NAVD88 and a design wave height for extreme conditions. Uplift over base varies from maximum still-water level on surge side to assumed protected side water elevation of -1.0 NAVD88 and wind on the exposed face of 30 psf.
- Case III – Same as Case Ia, but with gate recess de-watered and stop gates in place.
- Case IV – Same as Case I, but with earthquake loads applied from the north direction.
- Critical Conditions – Maximum bearing pressure occurred under maximum surge/hurricane loading.
- Base Slab – The maximum loading on the base occurs under Case III loading. Slab was designed to span parallel with the main channel with a net loading equal to the uplift minus the weight of the slab.
- Side Walls – The vertical height of the abutment side walls is 43 feet, with lateral spans of approximately 101.6 feet, 117.7 feet, and 136.0 feet. Walls were evaluated as two-way slabs acting as a cantilever from the base and as a beam horizontally.
- Gate Sill – The gate sill extends across the bottom of the channel opening and is designed to match the Verrazzano Narrow sill.

4.8.3 Sector Gate

The steel sector gates will be similar to the conventional secondary sector gate in the Verrazzano Narrows SSB. The steel gates will include bridges which connect all sector gate abutments (only when the gate is closed). The general plan dimensions of the sector gates remain the same as the Verrazzano Narrows secondary gate; however, the gate heights at Jamaica Bay are 43' rather than 64'. Therefore, the sector gates for Jamaica Bay utilize four (4) horizontal trusses compared to five (5) for Verrazzano Narrows. All other gate design components remain the same as previously described for Verrazzano Narrows.

The general dimensions of each of two units of each sector gate will be approximately 125 feet wide and 43 feet high, with an approximate weight of 600 tons each. The sector angle is 60 degrees and the radius of curvature 120 feet measured from the center of the trunnion to the outside face of the skin plate.

Analysis of the sector gate and anchorages were based on the following loading conditions:

- Case I – Maximum surge (hurricane) condition with water at a still-water elevation of +14.5 NAVD88 using a maximum wave with crest elevation of +33.1 feet NAVD88 and water on the protected side assumed at elevation -1.0 NAVD88. Lateral pressures figured by the Sainflow Method and design stresses increased by 33 percent.
- Case II – Gate pocket dewatered with water on the surge side at elevation +7.0 feet NAVD88. Pressure on stop-gates is considered as straight hydrostatic loading and stresses increased 33 percent.

4.8.4 Sector Gate Materials

See Verrazzano Narrows Secondary Sector Gate (section 3.14) for a description of sector gate materials and structural features. The two Jamaica Bay sector gates are intended to follow the same general construction with four (4) horizontal trusses rather than five (5) used for Verrazzano Narrows due to the shallower channel depths at Jamaica Bay.

4.8.5 Access Bridge

Due to the need for inspection vehicle (snooper truck) access, the sector gates will be designed and configured with vehicle access bridge segments on top of the gate.

Preliminarily, the gates are steel framed with an open steel grate travel surface. Fabricated steel sections will be used for vehicular and pedestrian barriers on each side of the bridge.

The bridge geometry is slightly serpentine to allow for required clearances when the gate segments are in the stowed position. When the gates are deployed (gates closed), the bridge segments meet at the centerline of the navigation passage with a geometric configuration that allows access from lift gate headwall to sector gate abutment, to access bridge, and so on.

4.8.6 Other Secondary Sector Gate Features

Other secondary sector gate features include:

- Control Building
- Maintenance Shop
- Control Systems Housings
- Inspection and Personnel Access Provisions
- Instrumentation
- Guard and Guide structures to prevent aberrant vessel collision

4.9 Lift Gate

In addition to two sector gates, the Jamaica Bay SSB includes 14 auxiliary vertical lift gates (VLGs). Each gate is 150 feet wide with horizontal bowstring arch trusses assembled from steel members having pipe and round HSS cross-sections (see Figure 4-2). The VLGs are slotted into

vertical recesses in concrete piers. Each pier typically has a recess on two opposing faces and serves as the lateral support of a pair of gates. Each pier is surmounted by a concrete tower. Each tower has a machinery room on top, housing the hoisting gear, again, typically for two gates. Gates will likely be raised using winches and bull gears, possibly augmented with counterweights. When lowered, the bottom of each gate seals against a concrete sill. Top-of-sill elevation varies from elevation -15 to -30 feet NAVD88 at this SSB.

Spanning from pier to pier across each gate opening, at the top of each gate is a concrete headwall, which provides protection against flooding from the top of the gate to elevation +18.0 feet NAVD88. The bottom of the headwall girder is at El. +8.0 feet NAVD88. This headwall also provides a one-way road bridge for inspection and light maintenance, 12 feet wide, at elevation +18.0 feet. The access road was designed to carry an under-bridge inspection vehicle; public access will not be permitted.

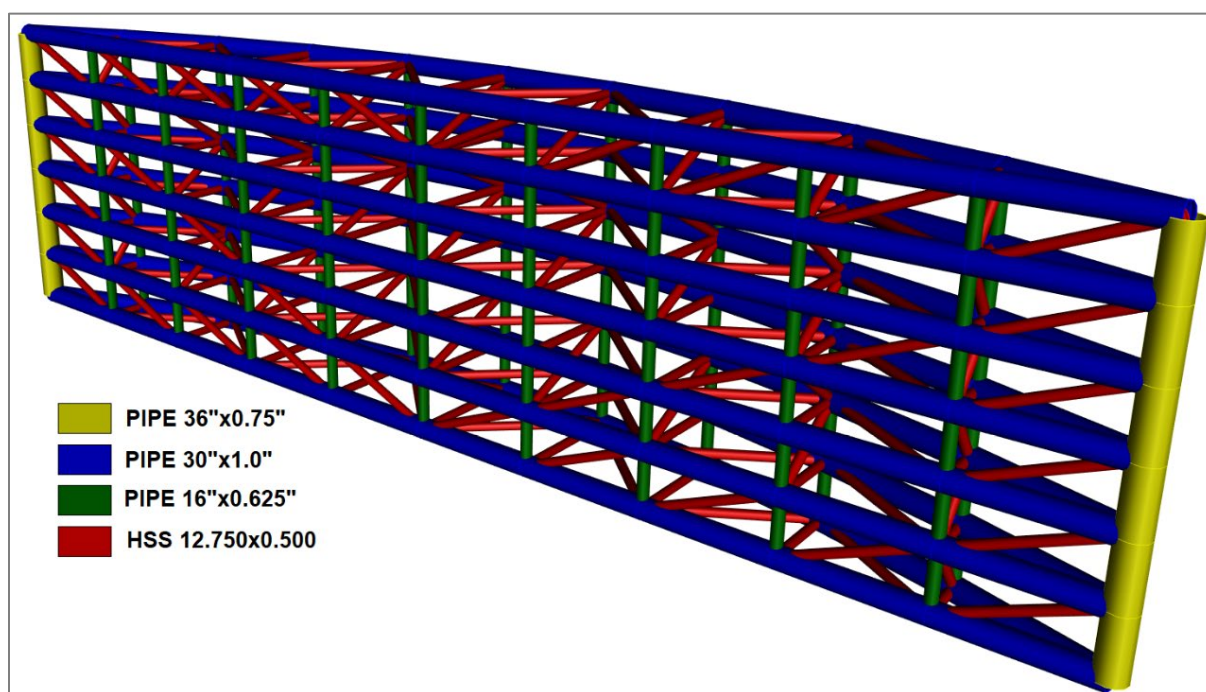

Figure 4-2: A Vertical Lift Gate at Jamaica Bay – Isometric View

Lift gate openings are not intended for commercial navigation; for this reason, the lift gates are also referenced as “auxiliary gates”. They allow for the flow of water, sediment, and marine life through the storm surge barrier during normal conditions. This reduces the environmental impact of the SSB. The greater the number, sill depth, and width of open lift gates, the lesser the magnification of current velocities as a result of reducing the cross-section of the natural waterway at the SSB.

The preliminary design of the lift gates at this SSB was based on existing structures, ETL 1110-2-584, EM 1110-2-2610, and the operation conditions expected at this location. For more details regarding the design, please refer to TSP Plan Set Sub-Appendix, which contains the plan set.

4.10 Scour Protection

4.10.1 Lift Gates

SSBs with a limited number of gate openings have the potential to cause some flow constriction in and out of Jamaica Bay. Scour aprons upstream and downstream of the lift gates are planned, with the objective of protecting the toe of structures against undermining caused by the increase in flow velocity through the harbor resulting from the reduction of flow area along the barrier alignment (long-term scour), and also for intensified scour during gate closure and opening (transient or short-term scour).

The scour apron for the vertical lift gates of the Jamaica Bay SSB is composed of a 165-foot bed of quarry-run stone, three to four feet thick, placed over a geotextile layer. For the 30 feet next to the sill, the quarry-run bed will be placed 5'-7" below the bottom-of-sill elevation, where the 5'-7" of depth will be filled with a double layer of stones of heavy grading. For details of the apron, please refer to TSP Plan Set Sub-Appendix, which contains the plan set for this SSB (and includes drawings of the typical cross-section of the apron).

4.11 Dam Sections and Tie-ins

For Jamaica Bay, the dam sections and tie-ins are configured as circular sheet pile cells with interconnecting arcs. Cells will be excavated to remove highly compressible and other weak materials, and will then be filled with well-drained granular fill. Dam sections and tie-ins transition between the landward-most pier(s) of the vertical lift gates and the shore-based measures at both sides of the bay.

5 Hackensack Storm Surge Barrier

5.1 Location

5.1.1 Hackensack River

The Hackensack River SSB location is on the Hackensack River in New Jersey, just downstream and to the south of the Newark-Jersey City Turnpike. The distance between the banks is approximately 1,600 feet (0.3 miles) at the proposed barrier location. Water depths vary from 20 feet to 30 feet. The proposed alignment corresponds closely to the alignment investigated in the previous USACE-NAN Hackensack River Basin Reconnaissance Report (USACE, February 1989). In addition, dimensions, features, and gate types proposed herein closely correspond to the recommended plan in 1989. It can also be noted that the proposed alignment is somewhat similar to that investigated in the previous Rebuild-by-Design Study (AECOM, 2018), yet the alignment studied therein is situated approximately 0.65 miles downstream from the location proposed in this report. The Hackensack River SSB is preliminarily sited along the westernmost transect (Hackensak01) depicted in Figure 5-1.

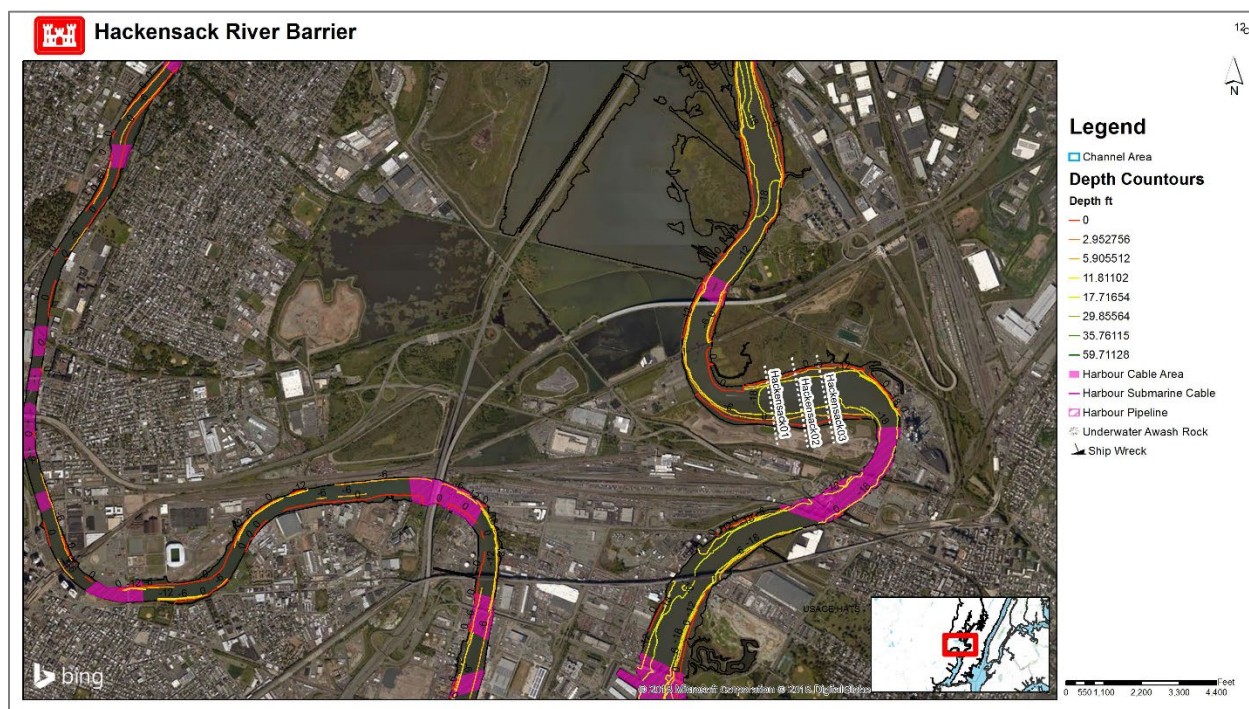

Figure 5-1: Area of Interest for the Hackensack Storm Surge Barrier Which Spans the Hackensack River in New Jersey

The existing cross-sectional flow area at the proposed storm surge barrier location is approximately 26,400 ft². The aggregated flow opening area provided within the conceptual design is approximately 17,000 ft² (approximately 64% of the existing flow area at that location).

5.2 General Phasing, Sequence, and Constructability

The Hackensack River Storm Surge Barrier (HR SSB) is composed of one Sector Gate, five Vertical Lift Gates with their corresponding piers (seven in total), and two dam sections at the north and south ends of the barrier alignment. The Line of Protection (LOP) for this barrier extends from north to south for over 1,460 feet, with the top-of-wall elevation at +19.0 feet NAVD88.

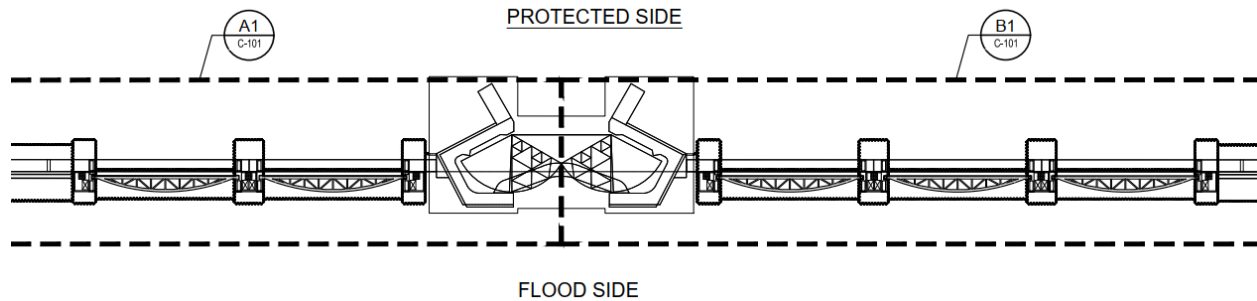

Figure 5-2: Area of Interest for the Hackensack Storm Surge Barrier Which Spans the Hackensack River in New Jersey

The proposed construction of this barrier will be divided into three stages:

- First construction stage: This stage encompasses the construction of the sector gate monolith and navigation channel approach walls. This stage will require starting construction in the middle of the river, which is a disadvantage in terms of construction access from shore; however, constructing the sector gate monolith first, to serve as both a temporary and final, permanent channel, allows river navigation, including barges, to cross the SSB while the lift gates are constructed.
- Second construction stage: This stage includes the construction of dam sections, piers, and vertical lift gates north of the sector gate.
- Third construction stage: This stage includes the construction of dam sections, piers, and vertical lift gates south of the sector gate.

For the second and third stages listed above, the use of cofferdams during construction is assumed. The construction sequence for these stages will be the following:

- 1) Excavate if needed and place sand and gravel fill to form a sub-base for the tremie seal of the cofferdam.
- 2) Drive pipe piles and install drilled shafts.
- 3) Install sealant in sheet pile interlocks, drive the coated sheet piles and install cofferdam bracing and king piles.
- 4) Place the underwater tremie concrete seal for the cofferdam. Dewater the cofferdam. Use barges as camels to prevent vessel impacts.
- 5) Clean and roughen the exposed surface of the concrete which was placed under water.

- 6) Prepare pile connections, weld headed studs onto sheet piles at sill/pile cap.
- 7) Install sill/pile cap reinforcement.
- 8) Pour concrete for sill/pile cap.
- 9) Roughen sill/pile cap concrete at any walls/piers.
- 10) Place rock fill to create slopes leading to gate sills where needed.
- 11) Form and pour any walls/piers.
- 12) Install the headwall/inspection road girders.
- 13) Flood the cofferdam.
- 14) Cut off cofferdam sheetpiles flush with top of sill/pile cap.
- 15) Install the steel gates.

For more details, please refer to Annex H with the plan set for the HR SSB.

5.3 Navigation Accommodation

The Hackensack River SSB is located upstream of the turning basin at the end of the Hackensack River Navigation Channel. There is very low traffic through the SSB site, as indicated by the traffic information obtained from AIS data. In fact, while we anticipate some towed barge activity, the AIS data examined showed no vessel of any type (cargo, tanker, tugboats, passenger, and pleasure) on that part of the river. A benefit is that this area will be less constrained by vessel traffic during construction.

Nevertheless, the assumed construction sequence begins with the sector gate, allowing enough space for navigation during construction Stage 1. The sector gate opening itself is expected to be used as a navigation channel during the second and third stages of construction.

The Interim Engineering Report presented an SSB with the following characteristics:

Table 5-1: Hackensack River SSB Characteristics

Navigable Pass	Design Ship Beam	Proposed Channel Width at Gate Location	Minimum Proposed Sill Depth	Air Clearance
Hackensack River	N/A**	100 ft*	-23 ft	102 ft

*Authorized channel is wider

**Not available in the Interim Report

Given the above, input from the navigation stakeholders participating in the navigation stakeholder meetings previously described was limited to the following:

- In general, the widths and depths of the proposed navigation gates were considered adequate.

- Fatal flaws with respect to navigation feasibility were not identified.

5.4 Sector Gates

The Hackensack River SSB includes one conventional steel sector gate with a navigable opening of 100 feet. This gate is similar to (and is derived from) the recreational sector gate considered at Verrazzano Narrows. The sector gate monolith is comprised of two abutments/gate recesses, for access and operation and storage of the sector gate, and a concrete sill against which the bottom of the sector gate seals when closed.

5.4.1 Foundations

Foundations for the sector gate abutment can be divided in two areas: the gate storage recesses/abutments, and the gate sill beneath the navigation channel.

For the gate abutment, a tremie seal concrete slab of approximately 90 feet x 140 feet, coinciding with the footprint of the temporary braced cofferdam required for construction, will be placed and supported over a 10-foot x 15-foot grid of 36-inch steel pipe piles arrayed over the tremie seal. The grid spacing is reduced to 9 feet x 9 feet in the area right below the gate abutment superstructure. After cofferdam dewatering, tremie piles will be extended and supported to rock using 20-foot rock sockets.

For the sector gate sill, a concrete slab of approximately 90 feet x 90 feet will be installed; this will match the braced cofferdam footprint required for construction. As in the case of the abutment foundation, a 10-foot x 15-foot grid of steel pipe piles will be arrayed over the sill, with rock sockets installed after cofferdam dewatering.

Construction of sector gate foundations will be in two phases: the first corresponding to gate concrete abutments, and the second for the sill (and gate installation). For more details, please refer to Annex H, which contains the sector gate plan.

5.4.2 Abutments and Gate Pockets

The abutments are concrete structures that rise over their concrete foundations from top-of-sill elevation at -23.0 feet NAVD88 to top-of-wall elevation at +19.0 feet. The abutments will provide storage for the leafs of the sector gate in the open configuration, and a connection point for the for the gate axle and gate operation machinery.

5.4.3 Sector Gates

The steel sector gate will be similar to the conventional recreational sector gate in the Verrazzano Narrows SSB. The steel gate will include a bridge which connects both sector gate abutments (only when the gate is closed).

5.5 Lift Gate

In addition to one conventional sector gate for navigation, the Hackensack River SSB includes five (5) auxiliary vertical lift gates (VLGs). Each gate is 150 feet wide with horizontal bowstring arch trusses assembled from steel members having pipe and round HSS cross-sections (see Figure 5-3). The VLGs are slotted into vertical recesses in concrete piers. Each pier typically has a recess on two opposing faces and serves as the lateral support of a pair of gates. Each pier is surmounted by a concrete tower. Each tower has a machinery room on top, housing the hoisting gear, again, typically for two gates. Gates will likely be raised using winches and bull gears, possibly augmented with counterweights. When lowered, the bottom of each gate seals against a concrete sill. The top-of-sill elevation at each gate opening is at Elevation -24 feet NAVD88.

Spanning from pier to pier across each gate opening, at the top of each gate, is a concrete headwall, which provides protection against flooding from the top of the gate to elevation +19.0 feet NAVD88. The bottom of the headwall girder is at El. +8.0 feet NAVD88. This headwall also provides a one-way road bridge for inspection and light maintenance, 12 feet wide, at elevation +19.0 feet. The access road was designed to carry an under-bridge inspection vehicle; public access will not be permitted.

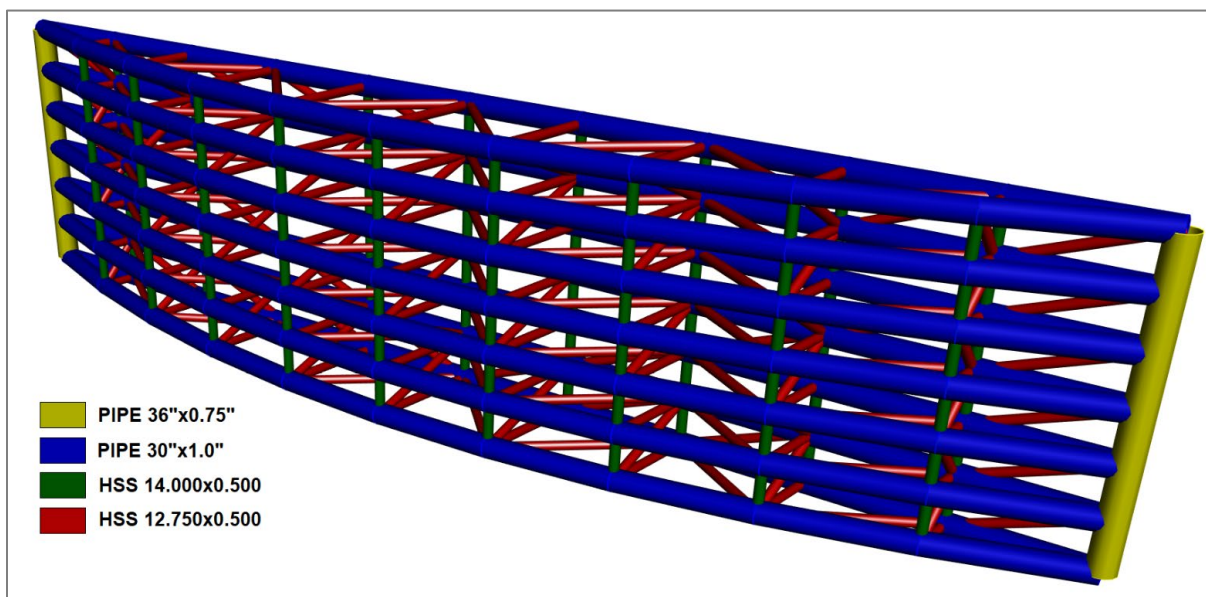

Figure 5-3: One of Five Vertical Lift Gates at the Hackensack River SSB – Isometric View

Lift gate openings are not intended for commercial navigation; for this reason, the lift gates are also referenced as “auxiliary gates”. They allow the flow of water, sediment, and fish through the storm surge barrier during normal conditions. This reduces the environmental impact of the SSB. The greater the number, sill depth, and width of open lift gates, the lesser the magnification of current velocities as a result of reducing the cross-section of the natural waterway at the SSB. Controlling current makes navigation less risky across the SSB.

The preliminary design of the lift gates at this SSB was based on existing structures, ETL 1110-2-584, EM 1110-2-2610, and the operation conditions expected at this location. For more details regarding the design, please refer to Annex H.

5.6 Scour Protection

5.6.1 Lift Gates

Unavoidably, SSBs with a limited number of gate openings will constrict flow through this part of the Hackensack River. Scour aprons upstream and downstream of the lift gates are planned, with the objective of protecting the toe of structures against undermining caused by the increase in flow velocity through the harbor resulting from the reduction of flow area along the barrier alignment (long-term scour), and also for intensified scour during gate closure and opening (transient or short-term scour).

The scour apron for the vertical lift gates of the Hackensack River SSB is composed of a 100-foot bed of quarry-run stone, three to four feet thick, placed over a geotextile layer. For the 30 feet next to the sill, the quarry-run bed will be placed 4'-0" below the bottom-of-sill elevation, where the 4-foot depth will be filled with a double layer of stones of heavy grading. For details of the apron, please refer to Annex H, which contains the plan set for this SSB, including drawings of the typical cross section of the apron.

5.7 Dam Sections and Tie-ins

For the HR SSB, the north and south ends of the SSB terminate as dam (floodwall) sections that tie-in to shore-based measures. The typical dam section is a T-wall, founded on three battered pipe piles every 12 feet along the barrier. Sheet pile cut-off walls along each edge of the pile cap will minimize seepage across the SSB when the gates are closed and there is a differential head. As for the rest of the SSB, the top-of-wall elevation of the dam sections is +19.0 feet NAVD88. The wall stem has a variable section with a thickness of 6 feet at the base and 4 feet at the top of wall.

To provide support for the access roadway girder, the stem of the dam has equally spaced counterforts every 90 feet on which the girder can be supported over elastomeric bearings. For more details regarding the preliminary design, refer to Annex H, which contains the plan set for this SSB.

6 Geometric Characteristics of All Storm Surge Barriers

6.1 Introduction

As brought forward in the introduction (Section 1), the NYNJHAT Study alternatives include 18 storm surge barriers. The majority of these storm surge barriers are part of the originally formulated study alternative and some storm surge barriers are part of the induced flooding mitigation features. An overview is provided in Table 6-1. All of these storm surge barriers provide for flood risk reduction during the 1% AEP event, including RSLC as detailed in the Basis of Design (Section 1). The three “reference storm surge barriers” have been described in detail in the preceding sections. This section provides a brief description of the design development of the remaining 15 storm surge barriers.

Table 6-1: Summary of Storm Surge Barriers Per Alternatives

Name	Abbr.	Type	Alt. 2	Alt. 3A	Alt. 3B	Alt. 4	Alt. 5
Outer Harbor	OH	SSB	YES				
Throgs Neck	TN	SSB	YES	YES			
Verrazzano Narrows	VN	SSB		YES			
Arthur Kill	AK	SSB		YES	YES		
Jamaica Bay	JB	SSB		YES	YES	YES	
Kill Van Kull	KVK	SSB			YES		
Hackensack River	HR	SSB				YES	
Newtown Creek	NC	SSB			YES	YES	
Gowanus Canal	GC	SSB			YES	YES	
Flushing Creek	FC	SSB			YES	YES	
Sheepshead Bay	SB	SSB		YES	YES	YES	
Gerritsen Creek	GRC	SSB		YES	YES	YES	
Induced Flooding Mitigation Features							
Eastchester Creek	EC	IFF SSB	YES	YES			
Port Washington	PW	IFF SSB	YES	YES			
Hempstead Harbor	HH	IFF SSB	YES	YES			
Hammond Creek	HC	IFF SSB	YES	YES			
Highlands	HL	IFF SSB		YES			
Raritan River	RR	IFF SSB		YES			

6.2 Methodology to Establish General Geometric Characteristics

The purpose of the storm surge barrier is to impede storm surge when closed, yet maintain tidal flow exchange between the ocean and the upstream water body, e.g., bay, basin, or river, during normal conditions when the gates are open. Each of these storm surge barriers will have a navigable passage to allow for vessels to pass and, where the water way is wide enough, auxiliary flow gates to maintain tidal flow exchange. Based on the functional requirements presented in

Section 2.6, the conceptual design of the storm surge barriers aims to maximize the number of flow gate openings and minimize the portion of “dam section” of the storm surge barrier. The auxiliary flow gates serve to maximize the water exchange through the opening and minimize impacts on the inner basin environmental conditions during normal hydrodynamic and meteorological conditions. At the tie-in locations of the storm surge barrier to the shore-based system, i.e., shallow waters, a dam section on the order of 100 feet to 1,000 feet long, depending on the location, would be needed. This dam section will be the transition between the operable SSB gate structure and shore-based flood risk reduction measures.

As discussed in Section 1.2, the locations of the storm surge barriers discussed herein have been developed during the plan formulation phase of the study and are, for the most part, determined by the extent and location of the perimeter risk reduction systems that are part of the NYNJHAT Study Alternatives. Once a location has been set, the overall geometry is then dictated by the existing bathymetry, geometry of the navigable passage(s), and the auxiliary flow gates given the existing bathymetric profile and the design criteria as summarized in Section 1.

The following sections provide details on each storm surge barrier within the NYNJHAT Study and provide additional detail on the navigable passage and auxiliary flow gates, respectively. An evaluation of maritime traffic and the methodology to set the dimensions for the navigable passages is provided in Annex A. It should be emphasized that for all storm surge barriers presented herein, the design is conceptual and the presented geometry should be seen as a first iteration in a design process. The geometric characteristics for each storm surge barrier structure have sufficient detail such that a hybrid parametric cost estimate can be established. More detail on the development of cost estimates for the storm surge barrier structures is provided in the Cost Engineering Appendix.

6.3 Outer Harbor

The key hydraulic and geometric parameters for the conceptual design of the Outer Harbor storm surge barrier are summarized in this section. The key environmental criteria to which the storm surge barrier elevation is designed are summarized in Table 6-2.

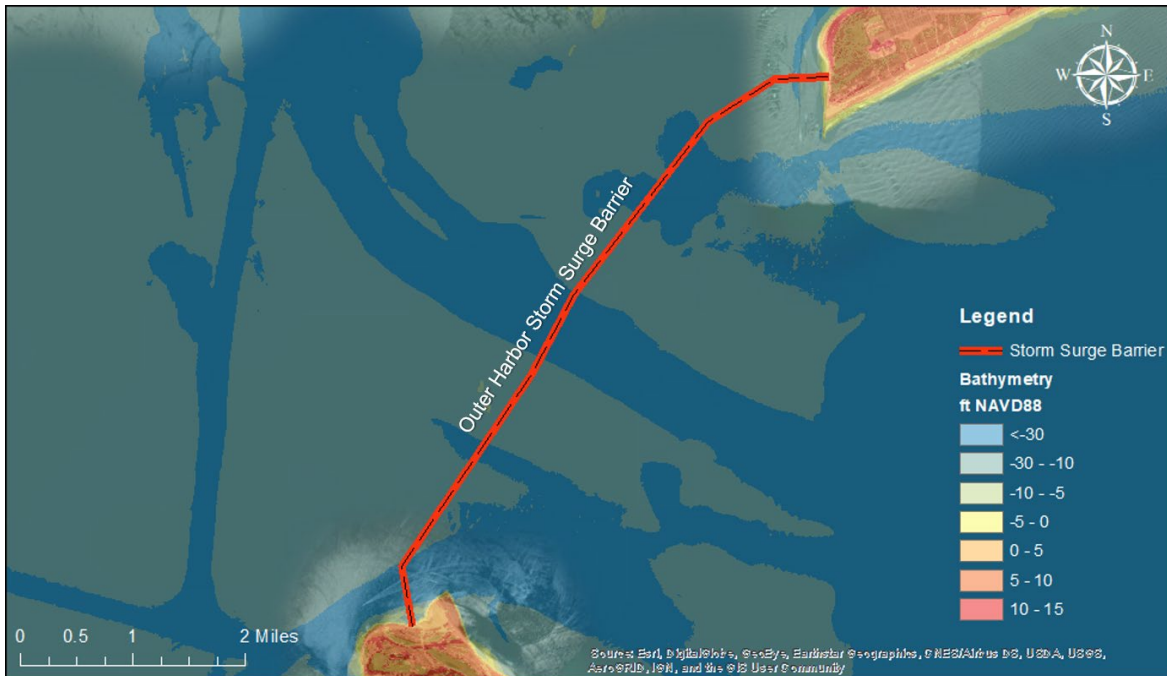

Figure 6-1: Outer Harbor Storm Surge Barrier Location and Bathymetry

Table 6-2: Summary of Environmental Design Criteria

Parameter	Value
RSLC for design life through 2095 (ft)	2.3
1% AEP Design Water Level (ft NAVD88) year 2095	13.3
1% AEP Significant Wave Height (ft)	16.1
1% AEP Peak Wave Period (s)	15.1
1% AEP Overtopping Criterion (l/s/m)	200

A preliminary geometry for the storm surge barrier openings has been established and is shown in Figure 6-2 through Figure 6-6. This geometry has been established based on the basis of design criteria as provided in Section 2 and includes navigable openings to accommodate navigation (see Annex A for establishing the minimum dimensions of the navigable openings) and a maximum number of auxiliary flow gates to maintain tidal exchange to the fullest extent possible. The OH SSB includes three navigable passages: One for the main navigation channel (Ambrose Channel), one at Sandy Hook and one at the Rockaway Inlet. The gate type selection for the navigable passages as well as the auxiliary flow opening is documented in Annex A. The existing cross-sectional flow area at the proposed storm surge barrier location is approximately 1,027,000 ft². The aggregated flow opening area provided within the conceptual design is 570,000 ft² (approximately 56% of the existing flow area at that location). This preliminary geometry is under evaluation with the use of hydrodynamic and ecological modeling (USACE ERDC, 2022).

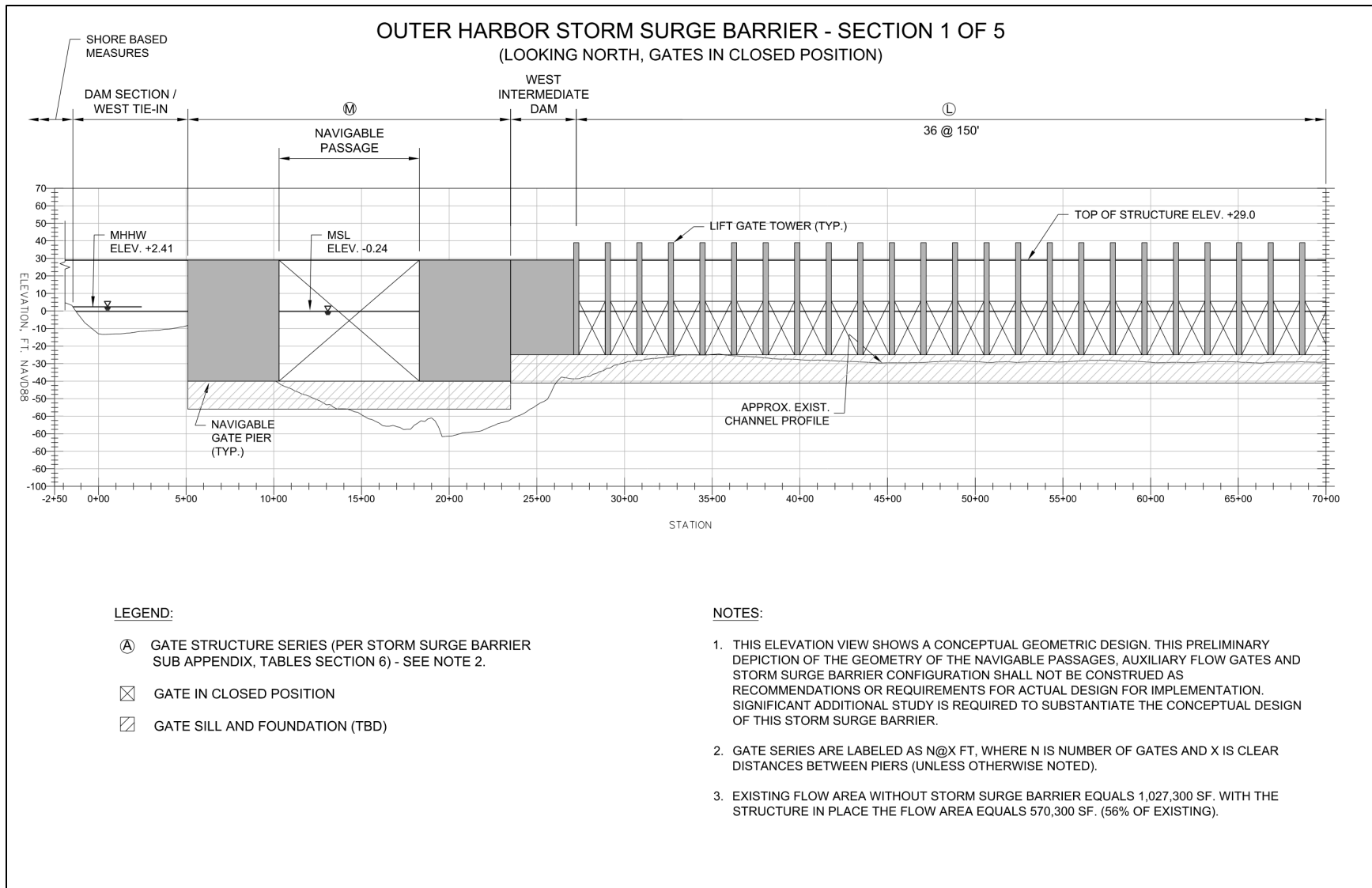
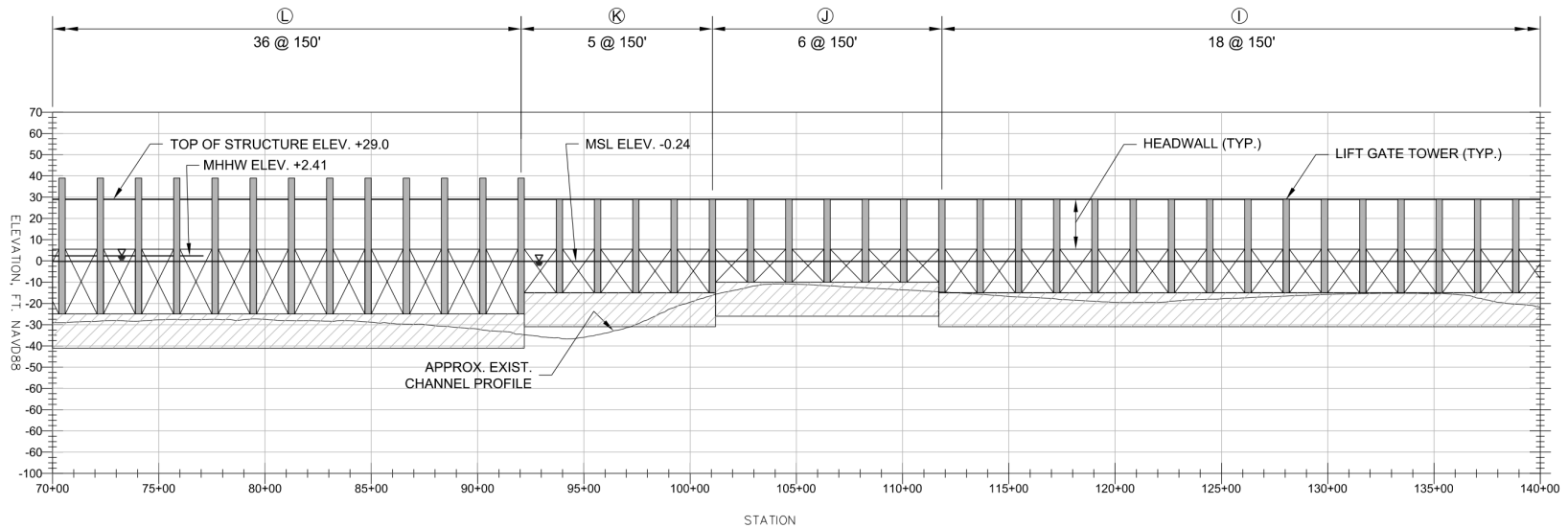

Figure 6-2: Conceptual Geometry of the Outer Harbor Storm Surge Barrier – Section 1 of 5.

OUTER HARBOR STORM SURGE BARRIER - SECTION 2 OF 5
(LOOKING NORTH, GATES IN CLOSED POSITION)



LEGEND:

- (A) GATE STRUCTURE SERIES (PER STORM SURGE BARRIER SUB APPENDIX, TABLES SECTION 6) - SEE NOTE 2.
- ☒ GATE IN CLOSED POSITION
- ☒ GATE SILL AND FOUNDATION (TBD)

NOTES:

1. THIS ELEVATION VIEW SHOWS A CONCEPTUAL GEOMETRIC DESIGN. THIS PRELIMINARY DEPICTION OF THE GEOMETRY OF THE NAVIGABLE PASSAGES, AUXILIARY FLOW GATES AND STORM SURGE BARRIER CONFIGURATION SHALL NOT BE CONSTRUED AS RECOMMENDATIONS OR REQUIREMENTS FOR ACTUAL DESIGN FOR IMPLEMENTATION. SIGNIFICANT ADDITIONAL STUDY IS REQUIRED TO SUBSTANTIATE THE CONCEPTUAL DESIGN OF THIS STORM SURGE BARRIER.
2. GATE SERIES ARE LABELED AS N@X FT, WHERE N IS NUMBER OF GATES AND X IS CLEAR DISTANCES BETWEEN PIERS (UNLESS OTHERWISE NOTED).
3. EXISTING FLOW AREA WITHOUT STORM SURGE BARRIER EQUALS 1,027,300 SF. WITH THE STRUCTURE IN PLACE THE FLOW AREA EQUALS 570,300 SF. (56% OF EXISTING).

Figure 6-3: Conceptual Geometry of the Outer Harbor Storm Surge Barrier – Section 2 of 5

OUTER HARBOR STORM SURGE BARRIER - SECTION 3 OF 5
(LOOKING NORTH, GATES IN CLOSED POSITION)

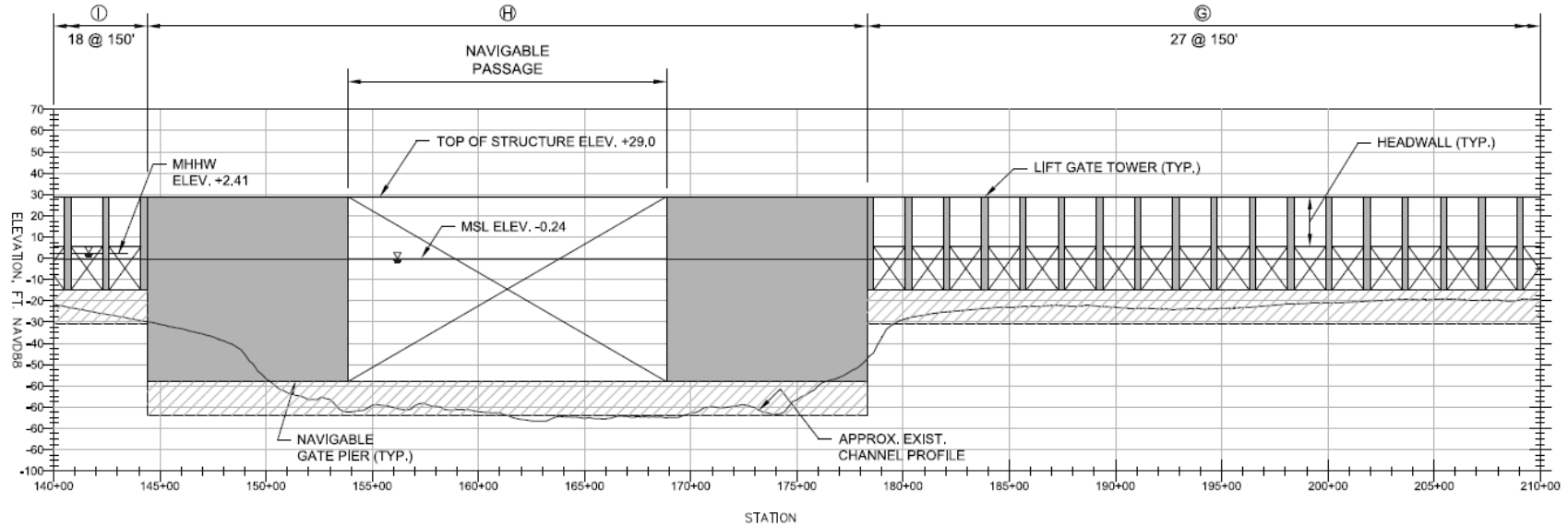

LEGEND:

- Ⓐ GATE STRUCTURE SERIES (PER STORM SURGE BARRIER SUB APPENDIX, TABLES SECTION 6) - SEE NOTE 2.
- ⊠ GATE IN CLOSED POSITION
- ▨ GATE SILL AND FOUNDATION (TBD)

NOTES:

1. THIS ELEVATION VIEW SHOWS A CONCEPTUAL GEOMETRIC DESIGN. THIS PRELIMINARY DEPICTION OF THE GEOMETRY OF THE NAVIGABLE PASSAGES, AUXILIARY FLOW GATES AND STORM SURGE BARRIER CONFIGURATION SHALL NOT BE CONSTRUED AS RECOMMENDATIONS OR REQUIREMENTS FOR ACTUAL DESIGN FOR IMPLEMENTATION. SIGNIFICANT ADDITIONAL STUDY IS REQUIRED TO SUBSTANTIATE THE CONCEPTUAL DESIGN OF THIS STORM SURGE BARRIER.
2. GATE SERIES ARE LABELED AS N@X FT, WHERE N IS NUMBER OF GATES AND X IS CLEAR DISTANCES BETWEEN PIERS (UNLESS OTHERWISE NOTED).
3. EXISTING FLOW AREA WITHOUT STORM SURGE BARRIER EQUALS 1,027,300 SF, WITH THE STRUCTURE IN PLACE THE FLOW AREA EQUALS 570,300 SF. (56% OF EXISTING).

Figure 6-4: Conceptual Geometry of the Outer Harbor Storm Surge Barrier – Section 3 of 5

OUTER HARBOR STORM SURGE BARRIER - SECTION 4 OF 5
(LOOKING NORTH, GATES IN CLOSED POSITION)

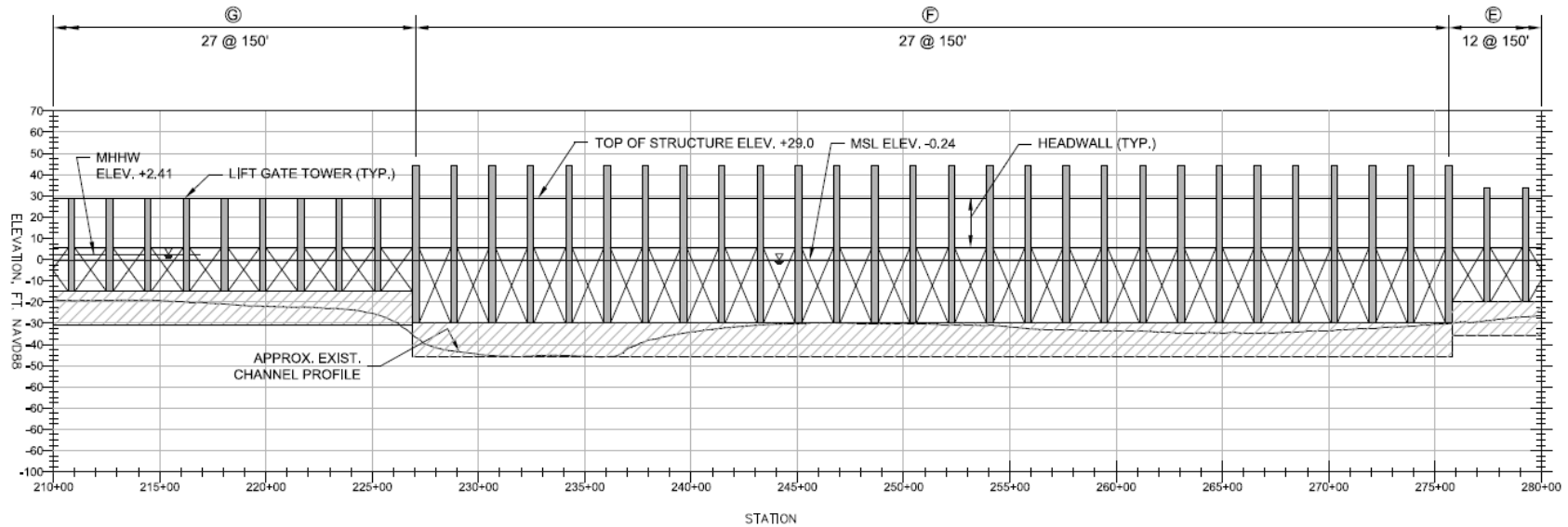

LEGEND:

- (A) GATE STRUCTURE SERIES (PER STORM SURGE BARRIER SUB APPENDIX, TABLES SECTION 6) - SEE NOTE 2.
- ⊠ GATE IN CLOSED POSITION
- ▨ GATE SILL AND FOUNDATION (TBD)

NOTES:

1. THIS ELEVATION VIEW SHOWS A CONCEPTUAL GEOMETRIC DESIGN. THIS PRELIMINARY DEPICTION OF THE GEOMETRY OF THE NAVIGABLE PASSAGES, AUXILIARY FLOW GATES AND STORM SURGE BARRIER CONFIGURATION SHALL NOT BE CONSTRUED AS RECOMMENDATIONS OR REQUIREMENTS FOR ACTUAL DESIGN FOR IMPLEMENTATION. SIGNIFICANT ADDITIONAL STUDY IS REQUIRED TO SUBSTANTIATE THE CONCEPTUAL DESIGN OF THIS STORM SURGE BARRIER.
2. GATE SERIES ARE LABELED AS N@X FT, WHERE N IS NUMBER OF GATES AND X IS CLEAR DISTANCES BETWEEN PIERS (UNLESS OTHERWISE NOTED).
3. EXISTING FLOW AREA WITHOUT STORM SURGE BARRIER EQUALS 1,027,300 SF, WITH THE STRUCTURE IN PLACE THE FLOW AREA EQUALS 570,300 SF. (56% OF EXISTING).

Figure 6-5: Conceptual Geometry of the Outer Harbor Storm Surge Barrier – Section 4 of 5

OUTER HARBOR STORM SURGE BARRIER - SECTION 5 OF 5
(LOOKING NORTH, GATES IN CLOSED POSITION)

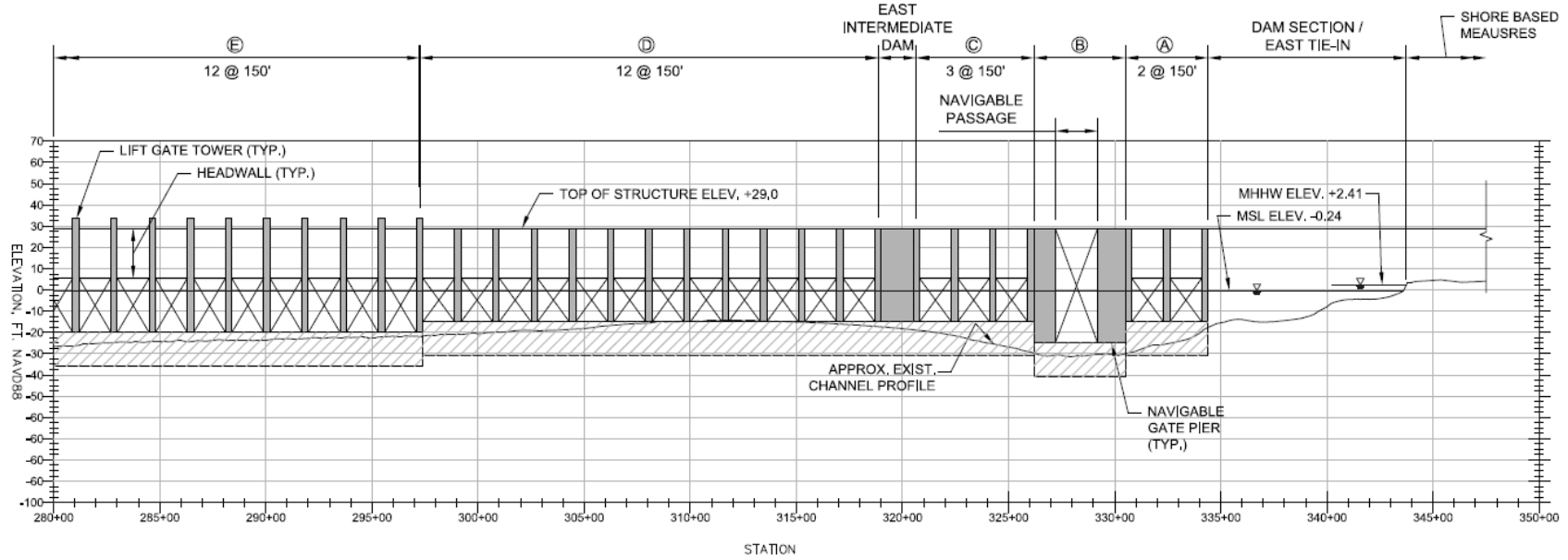

LEGEND:

- (A) GATE STRUCTURE SERIES (PER STORM SURGE BARRIER SUB APPENDIX, TABLES SECTION 6) - SEE NOTE 2.
- ☒ GATE IN CLOSED POSITION
- ☒ GATE SILL AND FOUNDATION (TBD)

NOTES:

1. THIS ELEVATION VIEW SHOWS A CONCEPTUAL GEOMETRIC DESIGN. THIS PRELIMINARY DEPICTION OF THE GEOMETRY OF THE NAVIGABLE PASSAGES, AUXILIARY FLOW GATES AND STORM SURGE BARRIER CONFIGURATION SHALL NOT BE CONSTRUED AS RECOMMENDATIONS OR REQUIREMENTS FOR ACTUAL DESIGN FOR IMPLEMENTATION. SIGNIFICANT ADDITIONAL STUDY IS REQUIRED TO SUBSTANTIATE THE CONCEPTUAL DESIGN OF THIS STORM SURGE BARRIER.
2. GATE SERIES ARE LABELED AS N@X FT, WHERE N IS NUMBER OF GATES AND X IS CLEAR DISTANCES BETWEEN PIERS (UNLESS OTHERWISE NOTED).
3. EXISTING FLOW AREA WITHOUT STORM SURGE BARRIER EQUALS 1,027,300 SF, WITH THE STRUCTURE IN PLACE THE FLOW AREA EQUALS 570,300 SF. (56% OF EXISTING).

Figure 6-6: Conceptual Geometry of the Outer Harbor Storm Surge Barrier – Section 5 of 5

Table 6-3 lists the gate series and show that a total of 151 gates are preliminarily included within this design. Three (3) navigation gates and 148 auxiliary flow gates. The gate series are provided a lettered ID to clearly distinguish between the various sill elevations. The vertical lift gate sill elevations vary between -10 feet NAVD88 and -30 feet NAVD88 in increments of 5 feet.

Table 6-3: Summary of the Outer Harbor Storm Surge Barrier Geometry – Navigable Passages and Auxiliary Flow Gates

Element ¹ (Gate Structure with Lettered ID)	No. Gates	Sill Elevation in ft NAVD88 (and in ft MLLW in parentheses)	Gate Width (ft)	Flow Area ¹ (ft ²)	Span ² (ft)	Notes	Top of Structure (ft, NAVD88)	Gate Height (ft)	Top of Lift Gate in Raised Position ³ (ft, NAVD88)
A	2	-15	150	4,428	390	Auxiliary Flow Gate (Vertical Lift Gate)	+29	22	29
B	1	-25 (-22)	200	4,952	460	Navigable Passage Rockaway Inlet (sector gate, vertical axes)	+29	54	N/A
C	3	-15	150	6,642	570	Auxiliary Flow Gate (Vertical Lift Gate)	+29	22	29
D	12	-15	150	26,568	2,190	Auxiliary Flow Gate (Vertical Lift Gate)	+29	22	29
E	12	-20	150	35,568	2,160	Auxiliary Flow Gate (Vertical Lift Gate)	+29	27	34
F	27	-30	150	120,528	4,860	Deepest Auxiliary Flow Gate (Vertical Lift Gate)	+29	37	44
G	27	-15	150	59,778	4,890	Auxiliary Flow Gate (Vertical Lift Gate)	+29	22	29
H	1	-58 (-55)	1,500	86,640	3,450	Navigable Passage Ambrose Channel (floating sector gate)	+29	87	N/A
I	18	-15	150	39,852	3,240	Auxiliary Flow Gate (Vertical Lift Gate)	+29	22	29
J	6	-10	150	8,784	1,080	Auxiliary Flow Gate (Vertical Lift Gate)	+29	17	24
K	5	-15	150	11,070	900	Auxiliary Flow Gate (Vertical Lift Gate)	+29	22	29
L	36	-25	150	133,704	6,510	Auxiliary Flow Gate (Vertical Lift Gate)	+29	32	39

Element ¹ (Gate Structure with Lettered ID)	No. Gates	Sill Elevation in ft NAVD88 (and in ft MLLW in parentheses)	Gate Width (ft)	Flow Area ¹ (ft ²)	Span ² (ft)	Notes	Top of Structure (ft, NAVD88)	Gate Height (ft)	Top of Lift Gate in Raised Position ³ (ft, NAVD88)
M	1	-40 (-37)	800	31,808	1,840	Navigable Passage Sandy Hook (floating sector gate)	+29	69	N/A
East Intermediate Dam	0	N/A	N/A	0	150	Intermediate Dam	+29	N/A	N/A
West Intermediate Dam	0	N/A	N/A	0	360	Intermediate Dam	+29	N/A	N/A
East Dam	0	N/A	N/A	0	935	Dam Section - Breezy Point, NY	+29	N/A	N/A
West Dam	0	N/A	N/A	0	655	Dam Section - Sandy Hook, NJ	+29	N/A	N/A
Total	151			570,322	34,640				

Notes

1 Flow area measured from elevation MSL to sill.

2 The span for navigable structures equals gate width + pier widths. Pier widths equal 65% of gate width, and the span for auxiliary structures equals gate width plus pier widths (pier widths equal 30 ft).

3 Top of single leaf lift gate with headwall at +7 ft.

6.4 Throgs Neck

This section summarizes the key hydraulic and geometric parameters for the conceptual design of the Throgs Neck storm surge barrier. Table 6-4 summarizes the key environmental criteria to which the storm surge barrier elevation is designed.



Figure 6-7: Throgs Neck Storm Surge Barrier Location and Bathymetry

Table 6-4: Summary of Environmental Design Criteria

Parameter	Value
RSLC for design life through 2095 (ft)	2.3
1% AEP Design Water Level (ft NAVD88) year 2095	15.3
1% AEP Significant Wave Height (ft)	4.3
1% AEP Peak Wave Period(s)	4.0
1% AEP Overtopping Criterion (l/s/m)	200

A preliminary geometry for the storm surge barrier openings has been established and is shown in Figure 6-8. This geometry has been established based on the basis of design criteria as provided in Section 2 and includes navigable openings to accommodate navigation (see Annex A for establishing the minimum dimensions of the navigable opening) and a maximum number of auxiliary flow gates to maintain tidal exchange to the fullest extent possible. The TN SSB includes one navigable passage. The gate type selection for the navigable passage as well as the auxiliary

flow opening is documented in Annex A. The existing cross-sectional flow area at the proposed storm surge barrier location is approximately 171,400 ft². The aggregated flow opening area provided within the conceptual design is 106,500 ft² (approximately 62% of the existing flow area at that location). This preliminary geometry is under evaluation with the use of hydrodynamic and ecological modeling (USACE ERDC, 2022).

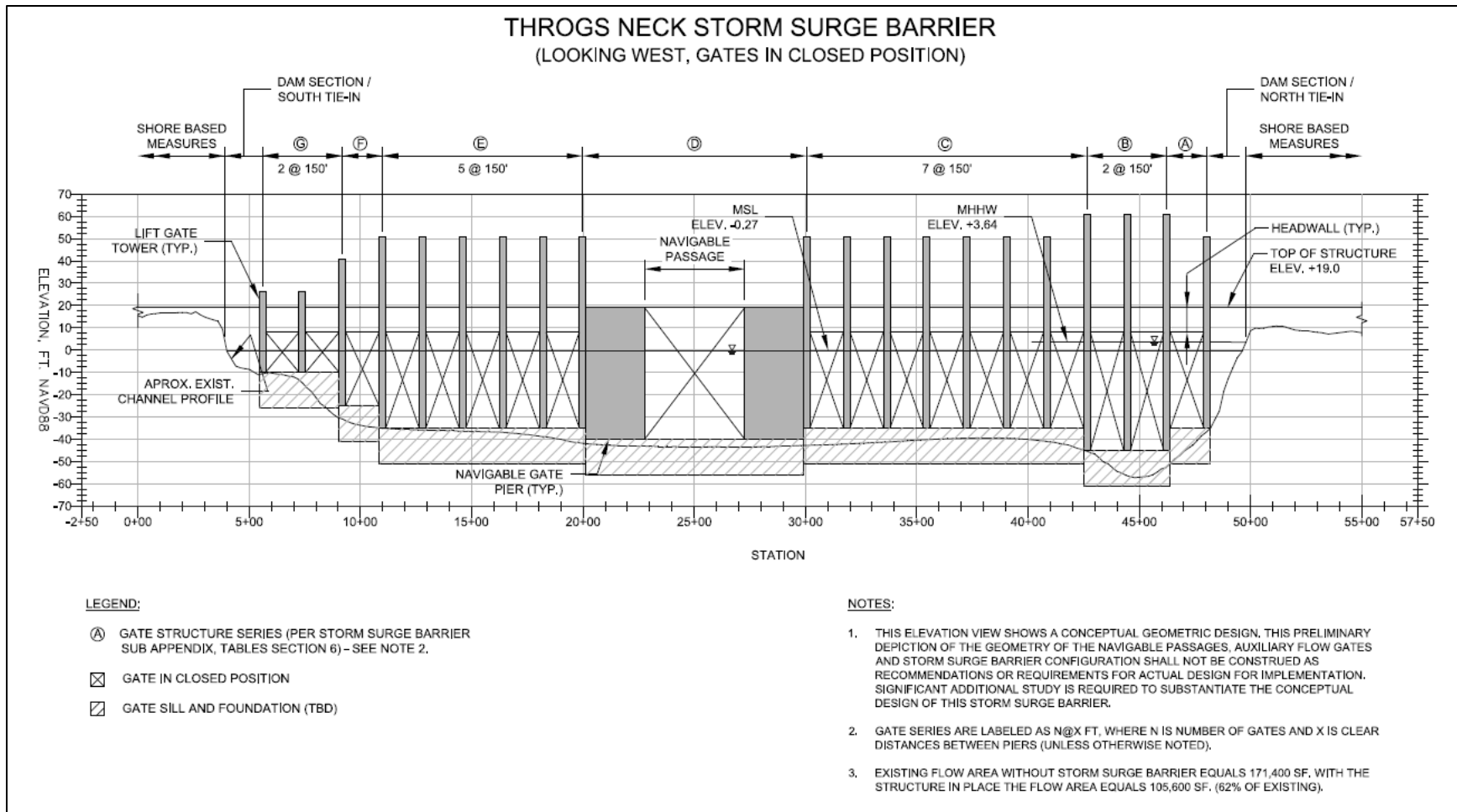

Figure 6-8: Conceptual Geometry of the Throgs Neck Storm Surge Barrier

Table 6-5 lists the gate series and show that a total of 19 gates are preliminarily included within this design. One (1) navigation gate and 18 auxiliary flow gates. The gate series are provided a lettered ID to clearly distinguish between the various sill elevations. The vertical lift gate sill elevations vary between -10 feet NAVD88 and -45 feet NAVD88.

Table 6-5: Summary of Throgs Neck Storm Surge Barrier Geometry – Navigable Passages and Auxiliary Flow Gates

Element ¹ (Gate Structure with Lettered ID)	No. Gates	Sill Elevation in ft NAVD88 (and in ft MLLW in parentheses)	Gate Width (ft)	Flow Area ¹ (ft ²)	Span ² (ft)	Notes	Top of Structure (ft, NAVD88)	Gate Height (ft)	Top of Lift Gate in Raised Position ³ (ft, NAVD88)
A	1	-35	150	5,210	180	Auxiliary Gate (vertical lift gate)	+19	43	51
B	2	-45	150	13,419	360	Auxiliary Gate (vertical lift gate)	+19	53	61
C	7	-35	150	36,467	1,290	Auxiliary Gate (vertical lift gate)	+19	43	51
D	1	-40 (-37)	450	17,879	1,036	Navigable Passage (floating sector gate)	+19	59	N/A
E	5	-35	150	26,048	900	Auxiliary Gate (vertical lift gate)	+19	43	51
F	1	-25	150	3,710	180	Auxiliary Gate (vertical lift gate)	+19	33	41
G	2	-10	150	2,919	390	Auxiliary Gate (vertical lift gate)	+19	18	26
North Dam	0	N/A	N/A	0	175	Dam Section - Westchester	+19	N/A	N/A
South Dam	0	N/A	N/A	0	165	Dam Section - Queens	+19	N/A	N/A
Total	19			105,650	4,676				

Notes

1 Flow area measured from elevation MSL to sill.

2 The span for navigable structures equals gate width + pier widths. Pier widths equal 65% of gate width for sector gates and the span for auxiliary structures equals gate width plus pier widths (pier widths equal 30 ft).

3 Top of single leaf lift gate with headwall at +8 ft.

6.5 Verrazzano Narrows

All details for the Verrazzano Narrows storm surge barrier are provided in Section 3.

6.6 Arthur Kill

6.6.1 Arthur Kill Conceptual Design

This section summarizes the key hydraulic and geometric parameters for the conceptual design of the Arthur Kill storm surge barrier. Table 6-6 summarizes the key environmental criteria to which the storm surge barrier elevation is designed.



Figure 6-9: Arthur Kill Storm Surge Barrier Location and Bathymetry

Table 6-6: Summary of Environmental Design Criteria

Parameter	Value
RSLC for design life through 2095 (ft)	2.3
1% AEP Design Water Level (ft NAVD88) year 2095	15.8
1% AEP Significant Wave Height (ft)	3.8
1% AEP Peak Wave Period(s)	3.3
1% AEP Overtopping Criterion (l/s/m)	200

A preliminary geometry for the storm surge barrier openings has been established and is shown in Figure 6-10. This geometry has been established based on the basis of design criteria as provided in Section 2 and includes one navigable opening to accommodate navigation (see Annex A for establishing the minimum dimensions of the navigable opening) and two flow gates to maintain tidal exchange to the fullest extent possible. The gate type selection for the navigable passage as well as the auxiliary flow opening is documented in Annex A. The existing cross-sectional flow area at the proposed storm surge barrier location is approximately 53,900 ft². The aggregated flow opening area provided within the conceptual design is 25,200 ft² (approximately 47% of the existing flow area at that location). This preliminary geometry is under evaluation with the use of hydrodynamic and ecological modeling (USACE ERDC, 2022).

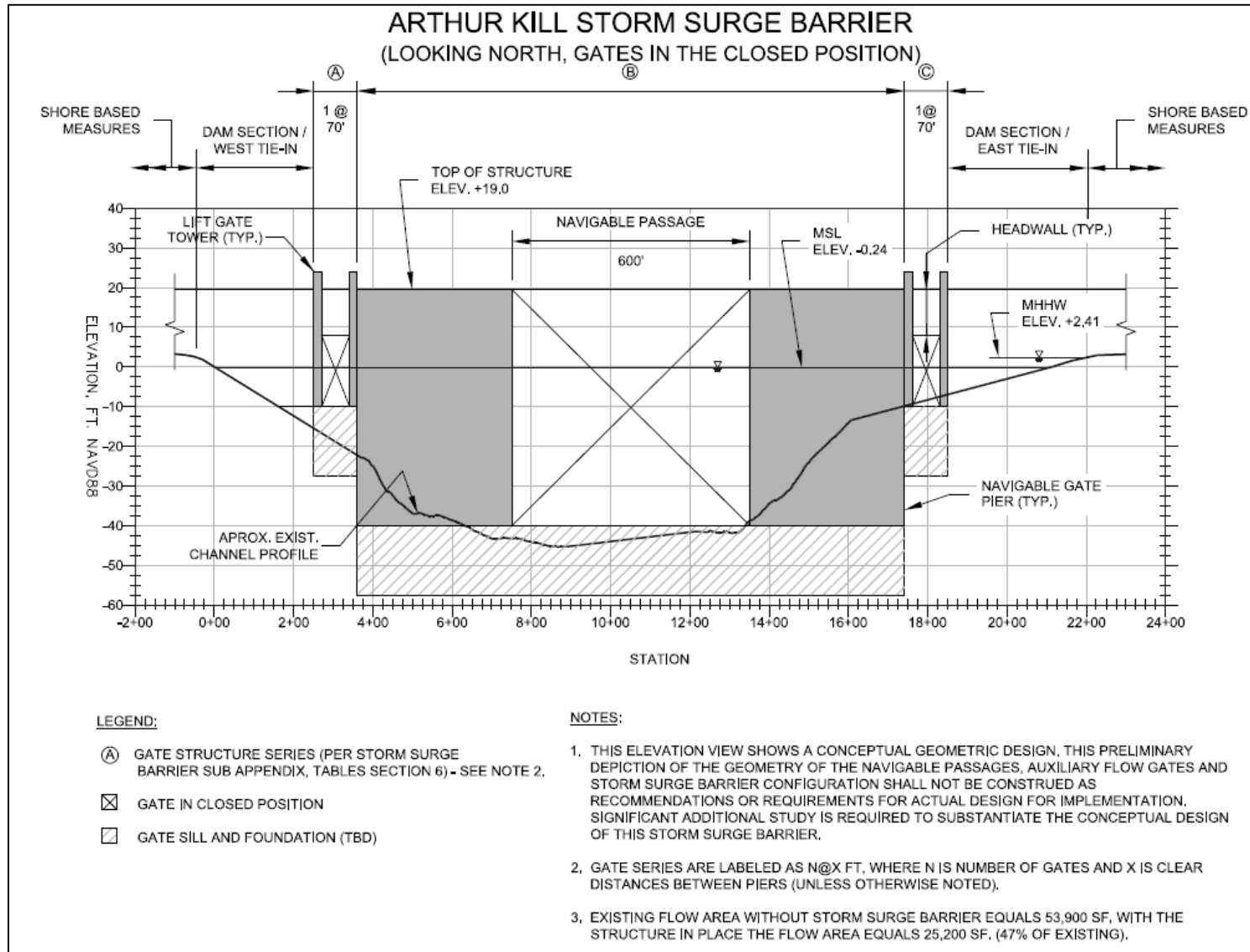

Figure 6-10: Conceptual Geometry of the Arthur Kill Storm Surge Barrier

Table 6-7 lists the gate series and show that a total of three (3) gates are preliminarily included within this design. One (1) navigation gate and two (2) auxiliary flow gates. The gate series are provided a lettered ID to clearly distinguish between the various sill elevations. The vertical lift gate sill elevations are at -10 feet NAVD88.

Table 6-7: Summary of Storm Surge Barrier Geometry – Navigable Passages and Auxiliary Flow Gates

Element ¹ (Gate Structure with Lettered ID)	No. Gates	Sill Elevation in ft NAVD88 (and in ft MLLW in parentheses)	Gate Width (ft)	Flow Area ¹ (ft ²)	Span ² (ft)	Notes	Top of Structure (ft NAVD88)	Gate Height (ft)	Top of Lift Gate in Raised Position ³ (ft, NAVD88)
A	1	-10	70	683	110	Auxiliary Gate (vertical lift gate)	+19	17	+24
B	1	-40 (-37)	600	23,856	1,380	Navigable Passage (floating sector gate)	+19	59	N/A
C	1	-10	70	683	110	Auxiliary Gate (vertical lift gate)	+19	17	+24
West Dam	0	N/A	N/A	0	295	Dam Section West Bank (New Jersey)	+19	N/A	N/A
East Dam	0	N/A	N/A	0	350	Dam Section East Bank (Staten Island)	+19	N/A	N/A
Total	3			25,222	2,245				

Notes

1 Flow area measured from elevation MSL to sill.

2 The span for navigable structures equals gate width + pier widths. Pier widths equal 65% of gate width, and the span for auxiliary structures equals gate width plus pier widths (pier widths equal 30 ft).

3 Top of single leaf lift gate with headwall at +7 ft.

6.6.2 Siting Considerations

The AK storm surge barrier conceptual design has been prepared to allow for a cost estimate. As noted earlier, no siting study had been completed for any of the SSBs under the NYNJHAT Study. During earlier stakeholder engagement there was some concern with the proposed location which is documented in Annex I. Comments from commercial and recreational pilots included concerns related to:

- 1) temporary navigation channels during construction,
- 2) approaches to navigable gates in the permanent channels, and
- 3) conflicts with designated anchorage areas.

Given the comments from the navigation stakeholder group and the costs associated with underwater rock excavation, additional alternative alignments were proposed and examined at a very high level for the Arthur Kill (AK), Kill Van Kull (KVK), and VN SSBs in early 2022. Potential changes identified for AK included shifting the SSB at AK north or south and enlarging the sector gate opening so that the final navigation channel could also serve as the channel during construction. At Arthur Kill, the conceptual design includes a floating sector gate with a width of 600 feet and two auxiliary lift gates. In the next phase, during refinement of the TSP, one alternative could consider an 800-foot gate without any auxiliary lift gates. This allows for a larger navigation opening that would better accommodate maritime traffic during construction and would allow land-based construction. In addition, the SSB location may be shifted (no more than 1,000 feet) north or south as part of such optimizations. Note that the AK SSB would be sited away from existing cable and pipeline crossings.

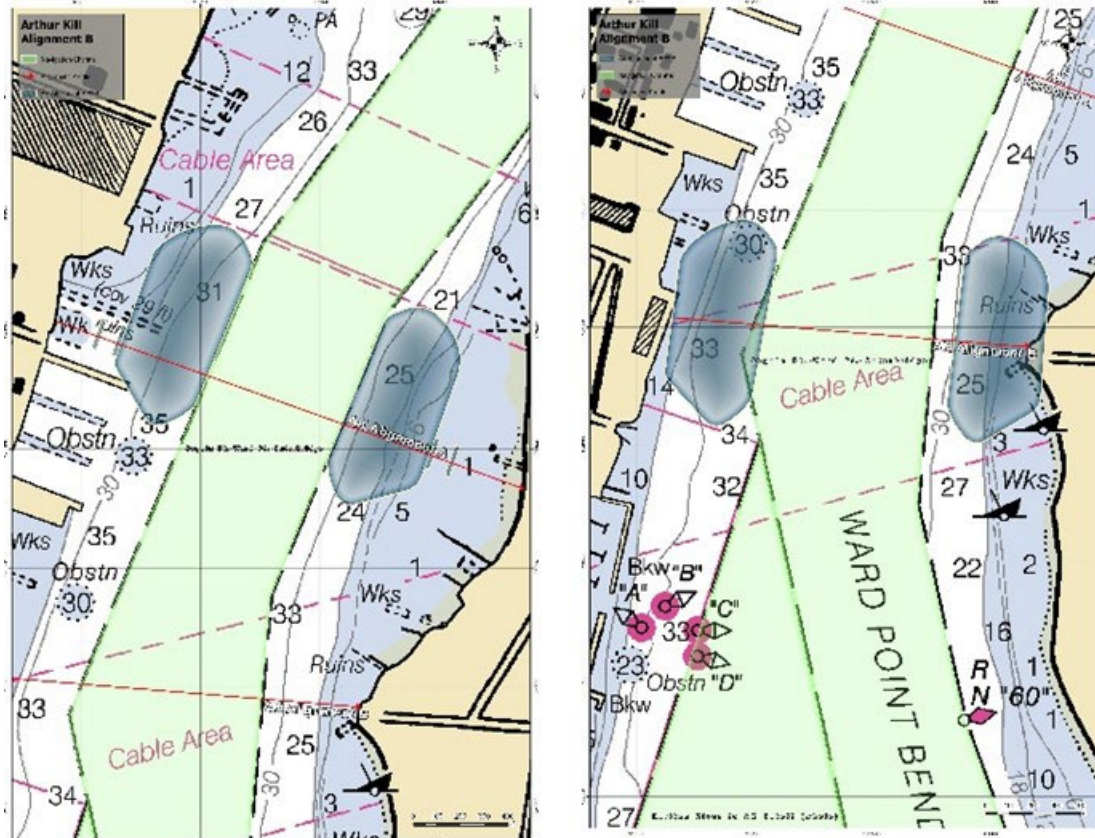

**Figure 6-11: Potential Alternative Arthur Kill Alignments (A and B)
(to be evaluated in the next phase)**

6.7 Jamaica Bay

All details for the Jamaica Bay storm surge barrier are provided in Section 4.

6.8 Kill Van Kull

6.8.1 Kill Van Kull Conceptual Design

This section summarizes the key hydraulic and geometric parameters for the conceptual design of the Kill Van Kull storm surge barrier. Table 6-8 below summarizes the key environmental criteria from Section 3 that determine the elevation of the conceptual storm surge barrier design.



Figure 6-12: Kill Van Kull Storm Surge Barrier Proposed Location and Bathymetry

Table 6-8: Summary of Environmental Design Criteria

Parameter	Value
RSLC for design life through 2095 (ft)	2.3
1% AEP Design Water Level (ft NAVD88) year 2095	13.8
1% AEP Significant Wave Height (ft)	6.0
1% AEP Peak Wave Period(s)	6.2
1% AEP Overtopping Criterion (l/s/m)	200

A preliminary geometry for the storm surge barrier openings has been established and is shown in Figure 6-13. This geometry has been established based on the basis of design criteria as provided in Section 2 and includes navigable one opening to accommodate navigation (see Annex A for establishing the minimum dimensions of the navigable opening) and a maximum number of auxiliary flow gates to maintain tidal exchange to the fullest extent possible. The gate type selection for the navigable passage as well as the auxiliary flow opening is documented in Annex A. The existing cross-sectional flow area at the proposed storm surge barrier location is approximately 121,000 ft². The aggregated flow opening area provided within the conceptual design is 66,000 ft² (approximately 55% of the existing flow area at that location). This preliminary geometry is under evaluation with the use of hydrodynamic and ecological modeling (USACE ERDC, 2022). Table 6-9 provides a summary of the overall storm surge barrier geometry presented herein.

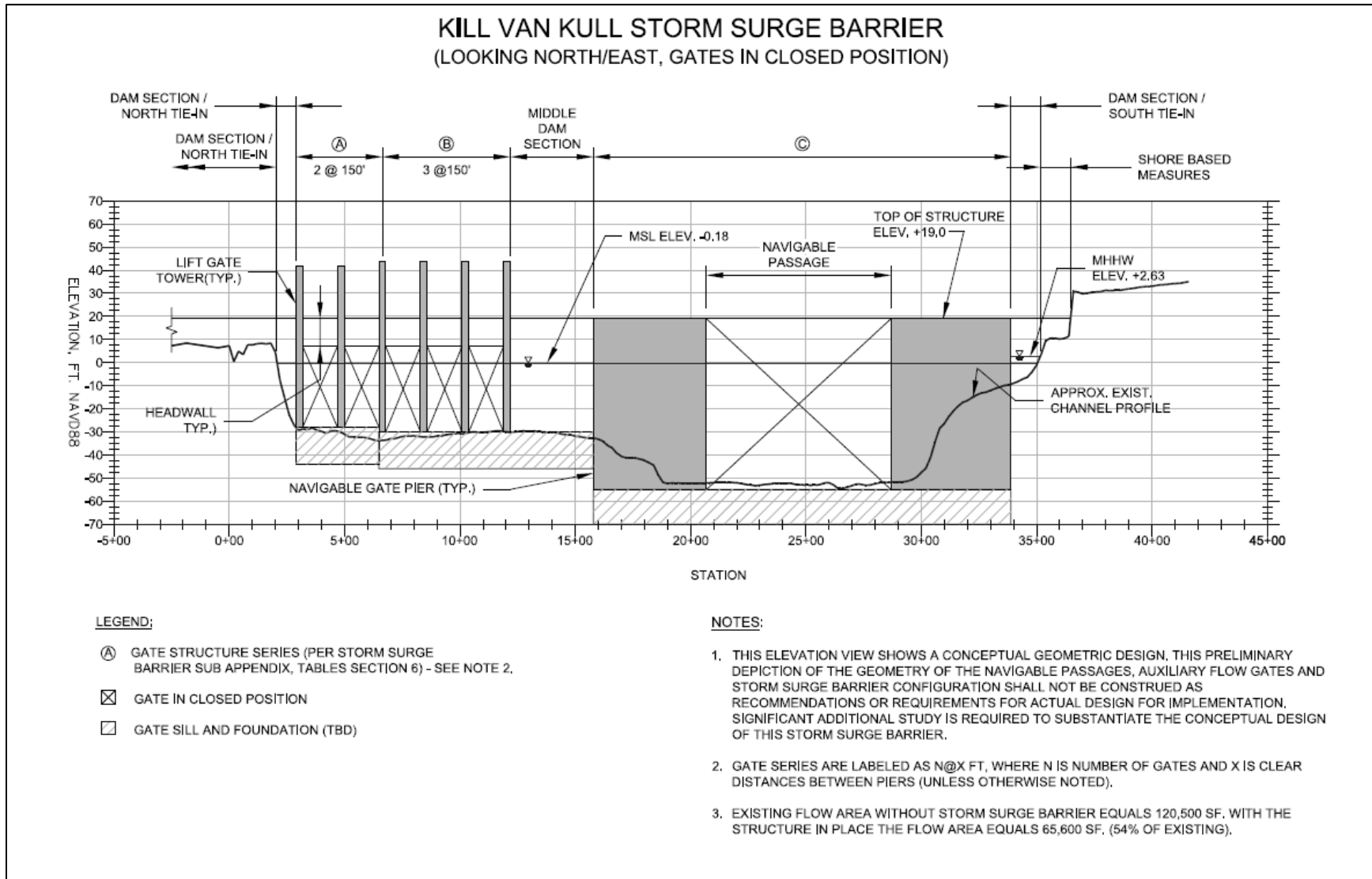

Figure 6-13: Conceptual Geometry of the Kill Van Kull Storm Surge Barrier

Table 6-9 lists the gate series and show that a total of six gates are preliminarily included within this design. One navigation gate and five auxiliary flow gates. The gate series are provided a lettered ID to clearly distinguish between the various sill elevations. The vertical lift gate sill elevations vary from -28 feet to -30 feet NAVD88 and the navigable gate sill is set at -55 feet NAVD88.

Table 6-9: Summary of Kill Van Kull Storm Surge Barrier Geometry – Navigable Passage and Auxiliary Flow Gates

Element ¹ (Gate Structure with Lettered ID)	No. Gates	Sill Elevation in ft NAVD88 (and in ft MLLW in parentheses)	Gate Width (ft)	Flow Area ¹ (ft ²)	Span ² (ft)	Notes	Top of Structure (ft NAVD88)	Gate Height (ft)	Top of Lift Gate in Raised Position ³ (ft, NAVD88)
A	2	-28	150	8,346	360	Auxiliary Gate (vertical lift gate)	+19	35	42
B	3	-30	150	13,419	570	Auxiliary Gate (vertical lift gate)	+19	37	44
C	1	-55 (-52)	800	43,856	1,840	Navigable Passage (floating sector gate)	+19	74	N/A
North Dam	0	N/A	N/A	0	85	Bayonne Dam	+19	N/A	N/A
South Dam	0	N/A	N/A	0	125	State Island Dam	+19	N/A	N/A
Intermediate Dam	0	N/A	N/A	0	300	Intermediate Dam	+19	N/A	N/A
Total	6			65,621	3,280				

Notes

1 Flow area measured from elevation MSL to sill.

2 The span for navigable structures equals gate width + pier widths. Pier widths equal 65% of gate width, and the span for auxiliary structures equals gate width plus pier widths (pier widths equal 30 ft).

3 Top of single leaf lift gate with headwall at +7 ft.

6.8.2 Additional Siting Considerations

The KVK storm surge barrier conceptual design has been prepared to allow for a cost estimate. As noted earlier, no siting study had been completed for any of the SSBs under the NYNJHAT Study. During earlier stakeholder engagement there was some concern with the proposed location which is documented in Annex I. Comments from commercial and recreational pilots included concerns related to:

- 1) Temporary navigation channels during construction,
- 2) Approaches to navigable gates in the permanent channels, and
- 3) Conflicts with designated anchorage areas.

In addition, the prospect of excavating underwater rock to create a temporary channel appeared overly expensive and time consuming. Early in 2022, additional alternative alignments were proposed and examined at a very high level for the Arthur Kill (AK), Kill Van Kull (KVK), and VN SSBs. Potential changes identified in an abbreviated siting study included shifting the KVK SSB east or west and enlarging the sector gate opening at KVK so that the final navigation channel could also serve as the channel during construction.

At Kill Van Kull, the concept design (as shown in the previous section includes a floating sector gate at 800 feet wide with five auxiliary flow gates (lift gates). Two alternatives were conceptualized to alleviate concerns raised by the navigation community:

- KVK Alignment C, which shifts the SSB east, enlarges the KVK floating sector gate opening to 1200 feet, and adds a 400-foot floating sector gate at the Pierhead Channel. See Figure 6-14.
- KVK Alignment D, which shifts the SSB west and enlarges the floating sector gate opening to 1,000 feet. As there will be no space for auxiliary lift gates, they will likely be removed from the SSB concept, see Figure 6-15.

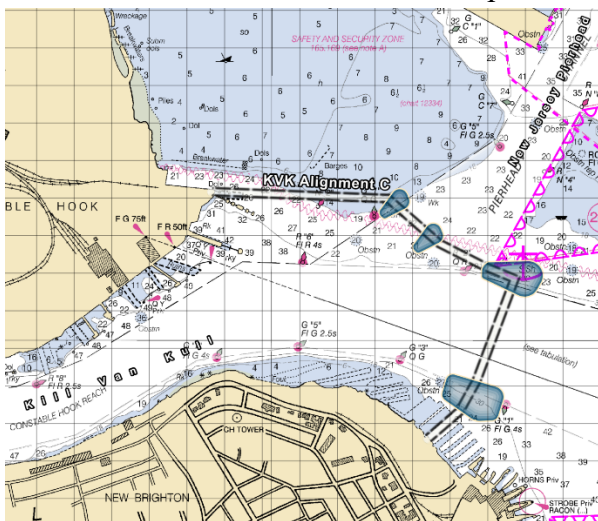

Figure 6-14: Kill Van Kull Alignment C

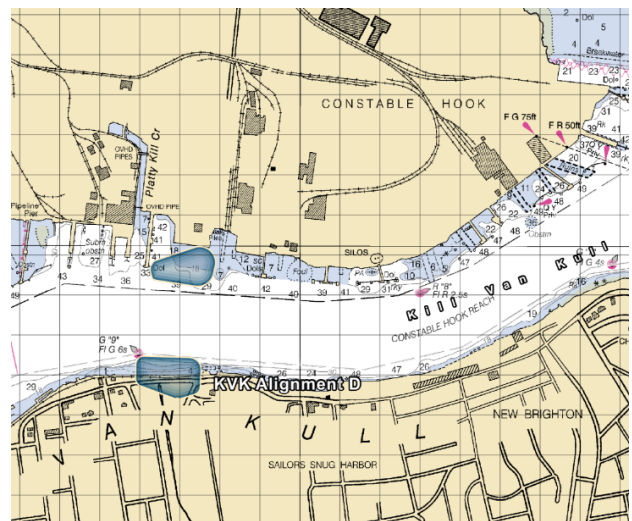

Figure 6-15: Kill Van Kull Alignment D

High-level cost estimates were prepared to understand the magnitude of the cost differential if such changes would be incorporated into the alternative at a later date. More details are available in the Cost Engineering Appendix.

As part of optimization of the TSP, during the next phase of this study, potential refinement to the KVK SSB alignment and structure design gates will be analyzed in greater detail.

6.9 Hackensack River

All details for the Hackensack River storm surge barrier are provided in Section 5.

6.10 Newtown Creek

This section summarizes the key hydraulic and geometric parameters for the conceptual design of the Newtown Creek Storm Surge Barrier (Figure 6-16). Table 6-10 below summarizes the key environmental criteria from Section 2 that determine the elevation of the conceptual storm surge barrier design.

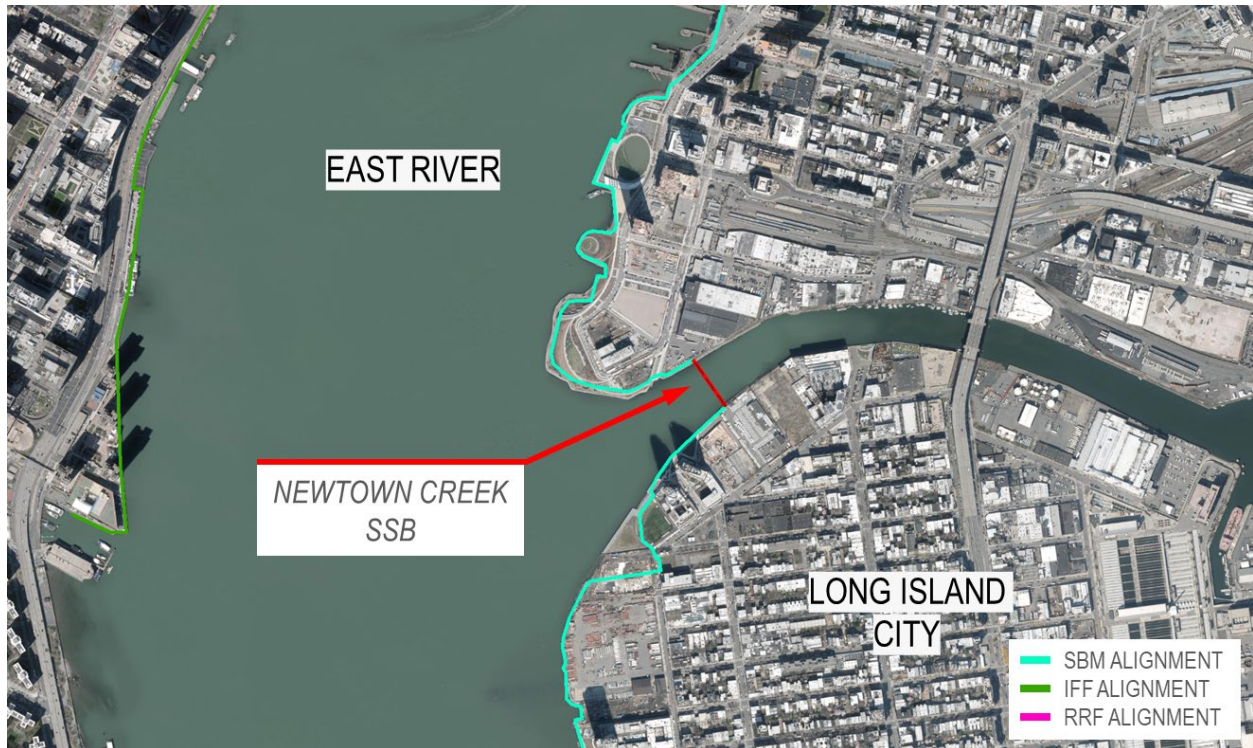

Figure 6-16: Newtown Creek Storm Surge Barrier Approximate Location.

Table 6-10: Summary of Environmental Design Criteria (Newtown Creek)

Parameter	Value
RSLC for design life through 2095 (ft)	1.9
1% AEP Design Water Level (ft NAVD88) year 2095	12.9
1% AEP Significant Wave Height (ft)	3.7
1% AEP Peak Wave Period (s)	3.2
1% AEP Overtopping Criterion (l/s/m)	200

A preliminary geometry for the storm surge barrier opening has been established and is shown in Figure 6-17. The barrier geometry has been established based on the basis of design criteria as provided in Section 2 and includes one navigable opening to accommodate navigation (see Annex A for establishing the minimum dimensions of the navigable opening). The gate type selection for the navigable passage is documented in Annex A. The existing cross-sectional flow area at the proposed storm surge barrier location is approximately 4,300 ft². The aggregated flow opening area provided within the conceptual design is 3,400 ft² (approximately 79% of the existing flow area at that location). The sector gate selected for the Newtown Creek barrier recesses into the existing shoreline of the creek and as such no in-water dam sections or tie-in structures are expected to be needed. The perimeter flood risk reduction features (land based) can directly tie in to the gate recess on either side of the creek. This preliminary geometry is under evaluation with the use of hydrodynamic and ecological modeling (USACE ERDC, 2022).

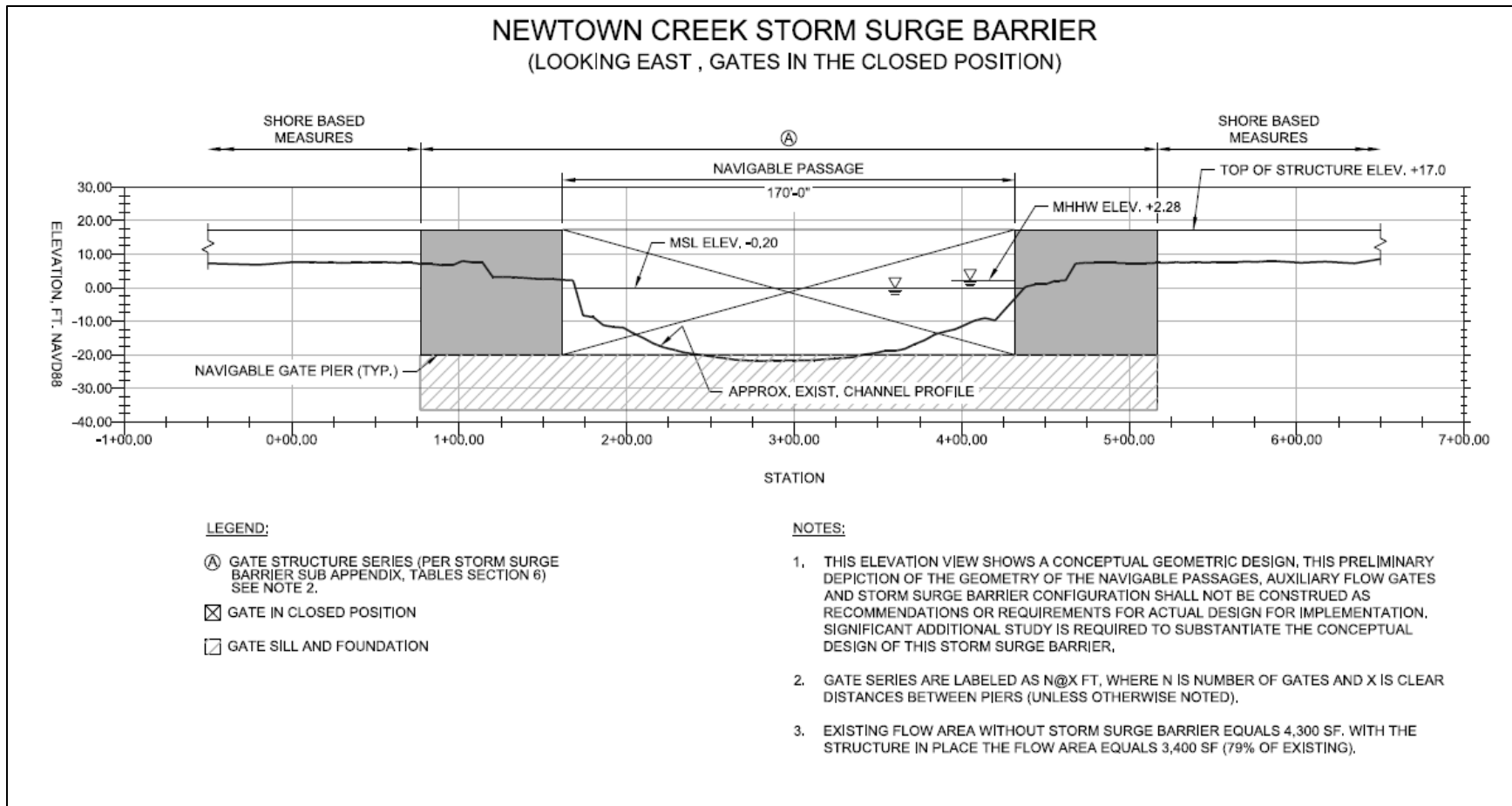

Figure 6-17: Conceptual Geometry of Gates of the Newtown Creek Storm Surge Barrier

Table 6-11: Summary of Newtown Creek Storm Surge Barrier Geometry – Navigable Passage

Element (Gate Structure with Lettered ID)	No. Gates	Sill Elevation in ft NAVD88 (and in ft MLLW in parentheses)	Gate Width (ft)	Flow Area¹ (ft²)	Span² (ft)	Note	Top of Structure (ft, NAVD88)	Gate Height (ft)
A	1	-20 (-18)	170	3,366	340	Navigable Passage (Sector Gate)	+17	37

Notes

¹ Flow area measured from elevation MSL to sill.

² The span for navigable structures equals gate width + pier widths. Pier widths equal 65% of gate width.

6.11 Gowanus Canal

This section summarizes the key hydraulic and geometric parameters for the conceptual design of the Gowanus Canal Storm Surge Barrier (Figure 6-18). Table 6-12 below summarizes the key environmental criteria from Section 3 that determine the elevation of the conceptual storm surge barrier design.

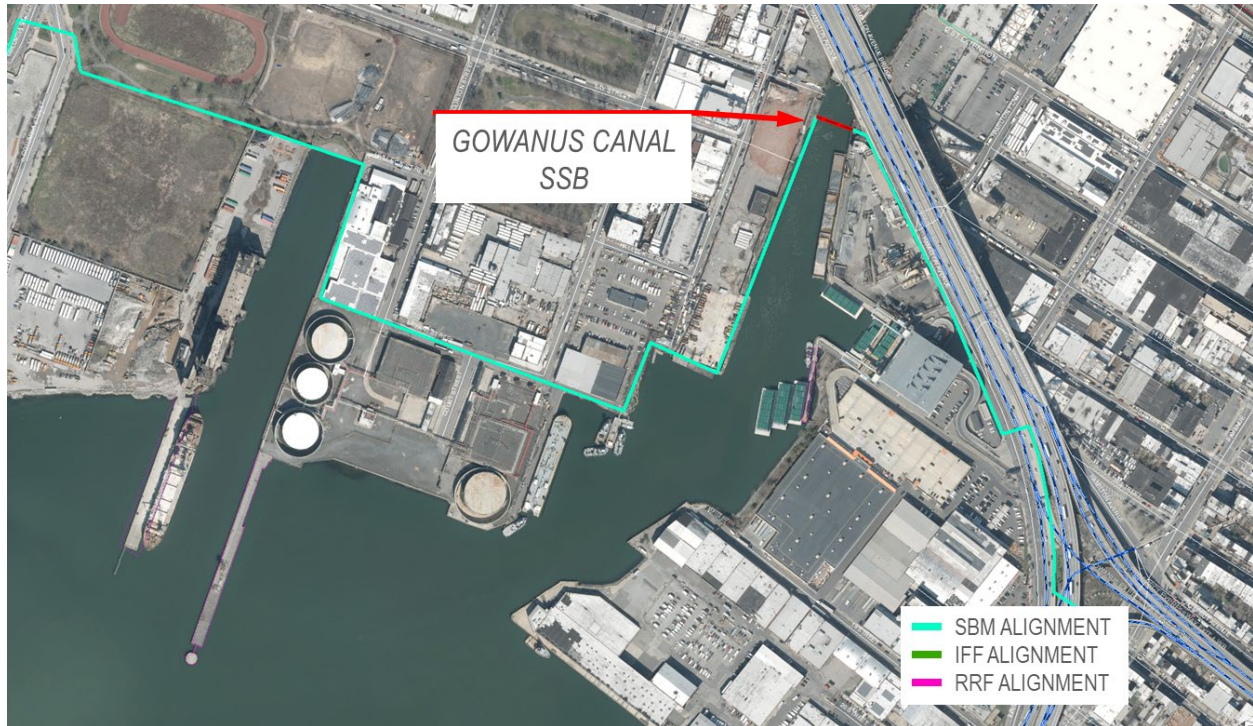

Figure 6-18: Gowanus Canal Storm Surge Barrier Location and Bathymetry

Table 6-12: Summary of Environmental Design Criteria (Gowanus Canal)

Parameter	Value
RSLC for design life through 2095 (ft)	1.9
1% AEP Design Water Level (ft NAVD88) year 2095	13.2
1% AEP Significant Wave Height (ft)	3.7
1% AEP Peak Wave Period(s)	3.1
1% AEP Overtopping Criterion (l/s/m)	200

A preliminary geometry for the storm surge barrier opening has been established and is shown in Figure 6-19. This geometry has been established based on the basis of design criteria as provided in Section 2 and includes one navigable opening to accommodate navigation (see Annex A for establishing the minimum dimensions of the navigable opening). The gate type selection for the

navigable passage is documented in Annex A. The existing cross-sectional flow area below MSL at the proposed storm surge barrier location is approximately 1,300 ft². The aggregated flow opening area provided within the conceptual design is 2,200 ft² (approximately 169% of the existing flow area at that location). It should be noted that because of significant shoaling in the canal, the existing canal provides less flow area than the proposed storm surge barrier would. However, deepening at the barrier location as part of the Super Fund work is anticipated prior to construction of the storm surge barrier. Given the observed shoaling problems an analysis of long-term sedimentation impacts and need for maintenance dredging is warranted. The miter gate selected for the Gowanus Canal barrier recesses, conservatively estimated at 30 feet wide each, into the existing shoreline of the canal. As a result, no in-water dam sections or tie-in structures are expected to be needed. The perimeter flood risk reduction features (land based) can directly tie in to the gate recess on either side of the canal. This preliminary geometry is under evaluation with the use of hydrodynamic and ecological modeling (USACE ERDC, 2022).

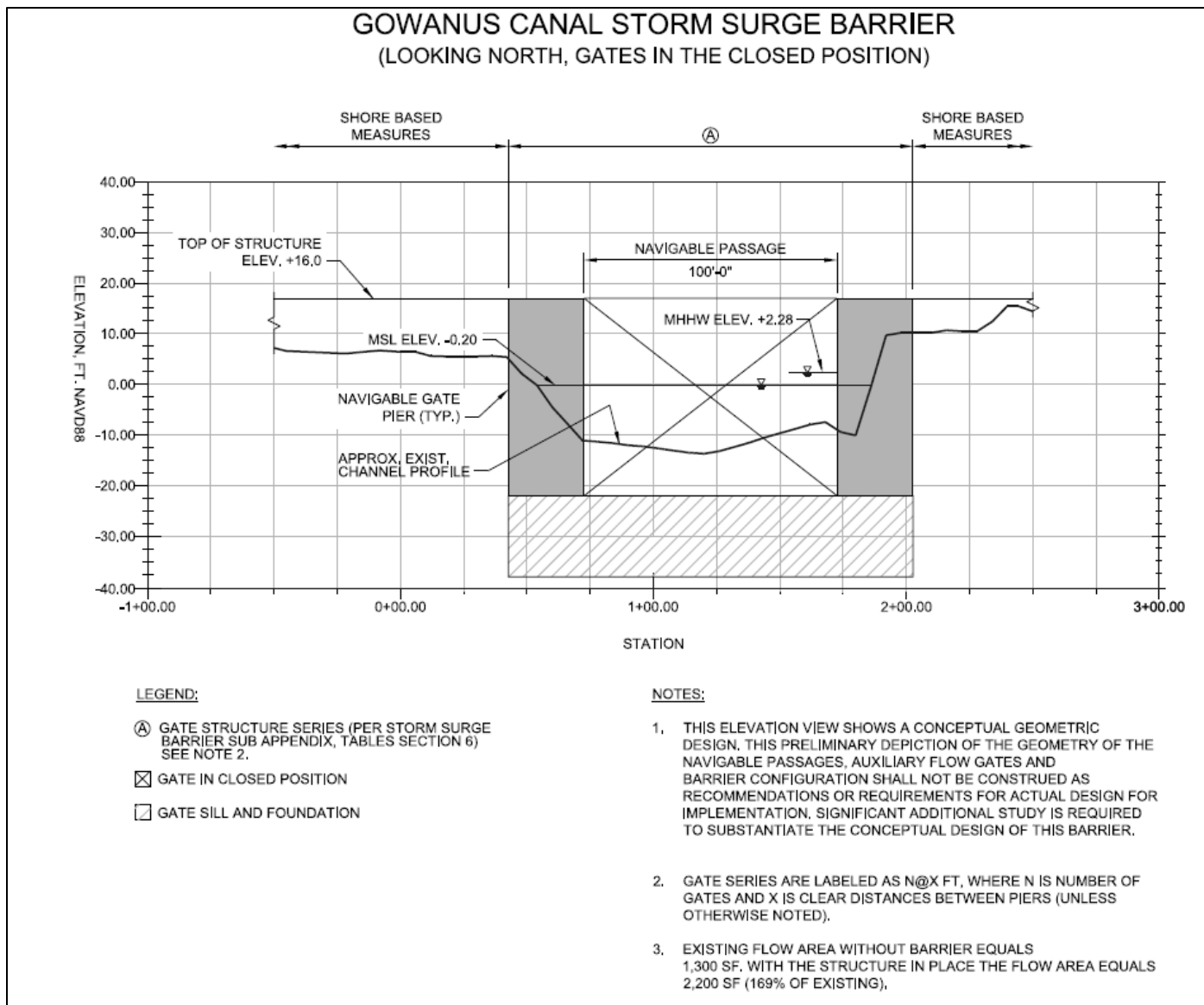

Figure 6-19: Conceptual Geometry of Gates of the Gowanus Canal Storm Surge Barrier

Table 6-13: Summary of Gowanus Canal Storm Surge Barrier Geometry – Navigable Passage

Element (Gate Structure with Lettered ID)	No. Gates	Sill Elevation in ft NAVD88 (and in ft MLLW in parentheses)	Gate Width (ft)	Flow Area¹ (ft²)	Span² (ft)	Note	Top of Structure (ft, NAVD88)	Gate Height (ft)
A	1	-22 (-20)	100	2,180	160	Navigable Passage (Miter Gate)	+16	38

Notes

1 Flow area measured from elevation MSL to sill.

2 Total span for gate structures equals gate width plus pier widths (30 ft each).

6.12 Flushing Creek

This section summarizes the key hydraulic and geometric parameters for the conceptual design of the Flushing Creek Storm Surge Barrier (Figure 6-20). Table 6-14 below summarizes the key environmental criteria from Section 3 that determine the elevation of the conceptual storm surge barrier design.



Figure 6-20: Flushing Creek Storm Surge Barrier Location and Bathymetry

Table 6-14: Summary of Environmental Design Criteria (Flushing Creek)

Parameter	Value
RSLC for design life through 2095 (ft)	1.74
1% AEP Design Water Level (ft NAVD88) year 2095	15.0
1% AEP Significant Wave Height (ft)	3.3
1% AEP Peak Wave Period (s)	2.6
1% AEP Overtopping Criterion (l/s/m)	200

A preliminary geometry for the storm surge barrier openings has been established and is shown in Figure 6-21. This geometry has been established based on the basis of design criteria as provided in Section 2 and includes one navigable opening to accommodate navigation (see Annex A for establishing the minimum dimensions of the navigable opening) and two auxiliary flow gates to maintain tidal exchange to the fullest extent possible. The gate type selection for the navigable passage is documented in Annex A. The existing cross-sectional flow area below MSL at the proposed storm surge barrier location is approximately 4,500 ft². The aggregated flow opening area provided within the conceptual design is 4,300 ft² (approximately 96% of the existing flow area at that location). This preliminary geometry is under evaluation with the use of hydrodynamic and ecological modeling (USACE ERDC, 2022).

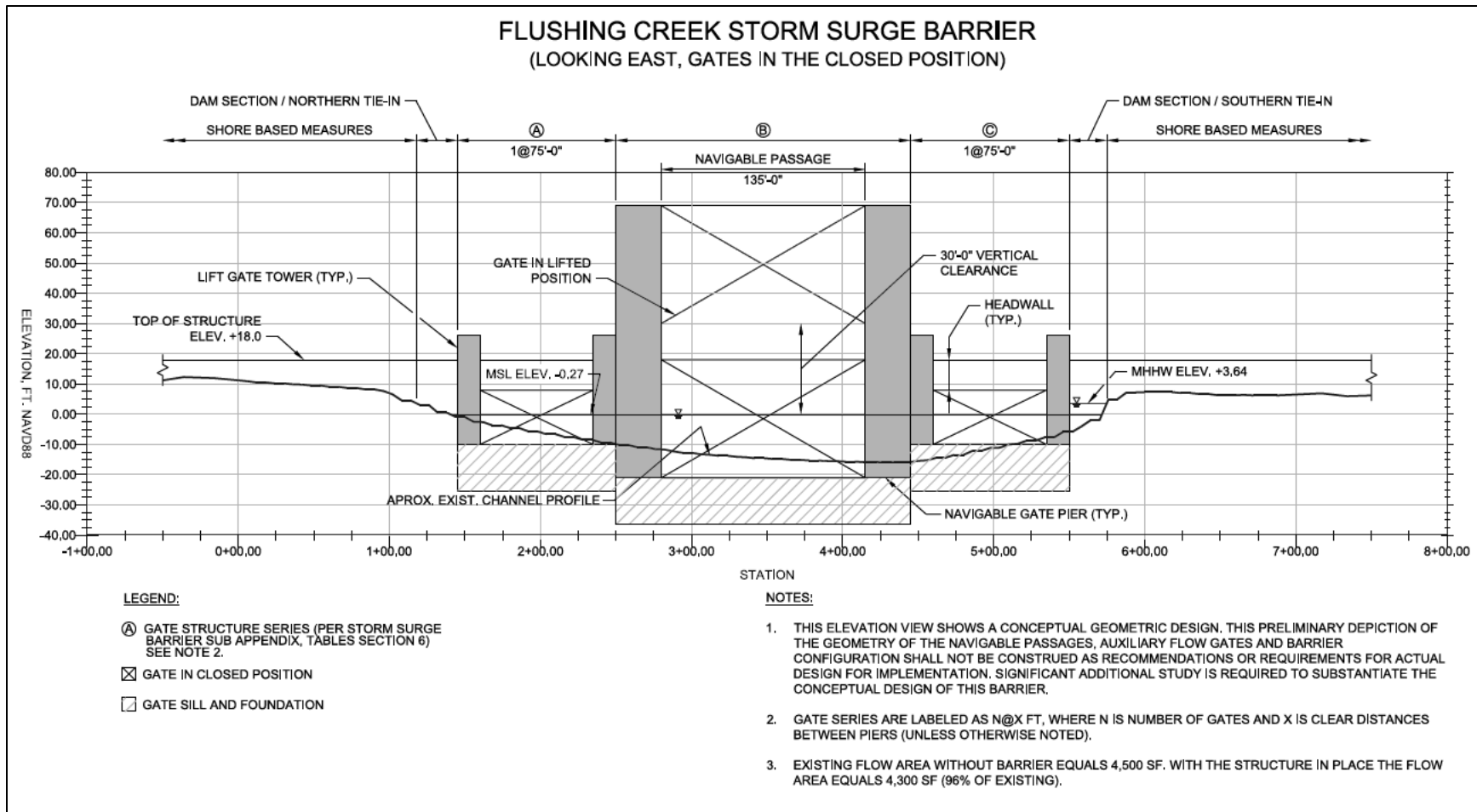

Figure 6-21: Conceptual Geometry of Gates of the Flushing Creek Storm Surge Barrier

Table 6-15: Summary of Flushing Creek Storm Surge Barrier Geometry – Navigable Passages and Auxiliary Flow Gates

Element (Gate Structure with Lettered ID)	No. Gates	Sill Elevation in ft NAVD88 (and in ft MLLW in parentheses)	Gate Width (ft)	Flow Area ¹ (ft ²)	Span ² (ft)	Note	Top of Structure (ft, NAVD88)	Gate Height (ft)	Top of Lift Gate in Raised Position ³ (ft, NAVD88)
A	1	-10	75	730	105	Auxiliary Flow Gate (Lift Gate)	+18	18	26
B	1	-21 (-17)	135	2,799	195	Navigable Passage (Lift Gate)	+18	39	69
C	1	-10	75	730	105	Auxiliary Flow Gate (Lift Gate)	+18	18	26
North Dam	0	N/A	N/A	0	30	Dam Section East Bank	+18	N/A	N/A
South Dam	0	N/A	N/A	0	25	Dam Section West Bank	+18	N/A	N/A
Total	3			4,259	460				

Notes:

1 Flow area measured from elevation MSL to sill.

2 The span for navigable structures equals gate width + pier widths. Pier widths (each) equal 30 ft for navigable gate width, and the span for auxiliary structures equals gate width plus pier widths (pier widths equal 15 ft).

3 Top of single leaf lift gate with headwall at +8 ft.

6.13 Sheepshead Bay

This section summarizes the key hydraulic and geometric parameters for the conceptual design of the Sheepshead Bay Storm Surge Barrier (Figure 6-22). Table 6-16 below summarizes the key environmental criteria from Section 3 that determine the elevation of the conceptual storm surge barrier design.

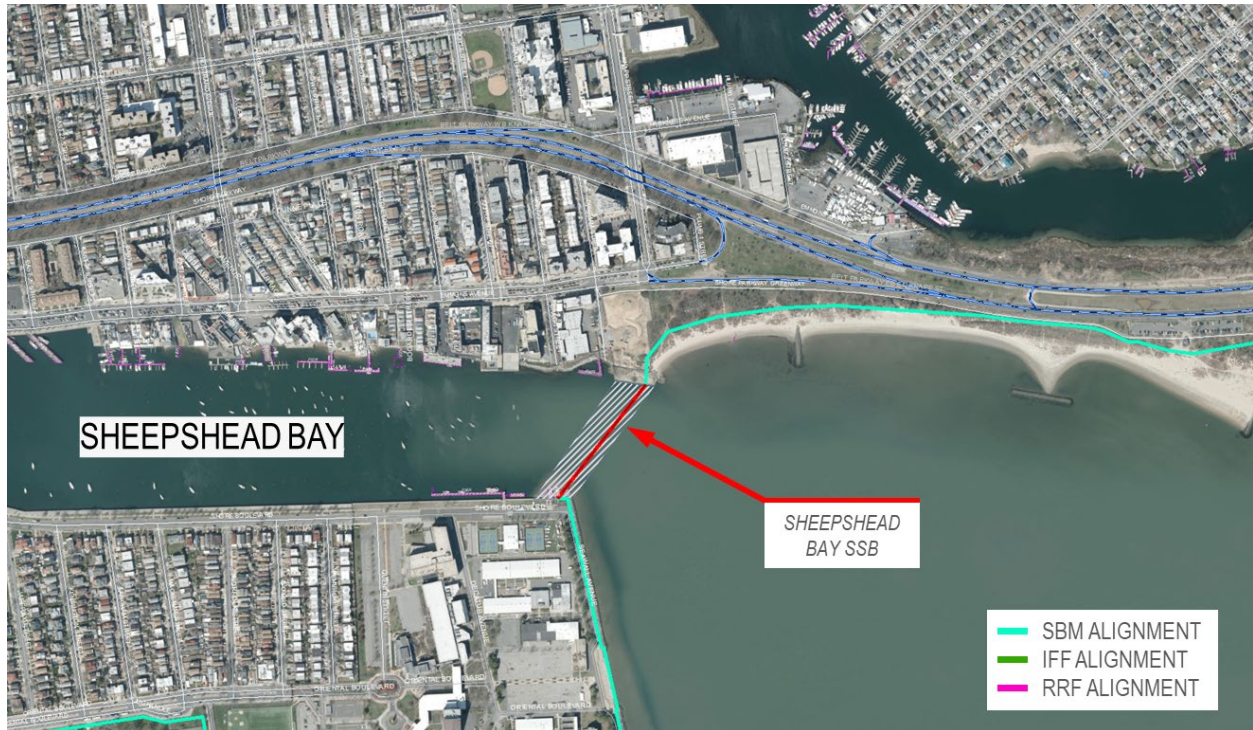

Figure 6-22: Sheepshead Bay Storm Surge Barrier Approximate Location.

Table 6-16: Summary of Environmental Design Criteria (Sheepshead Bay)

Parameter	Value
RSLC for design life through 2095 (ft)	2.29
1% AEP Design Water Level (ft NAVD88) year 2095	12.2
1% AEP Significant Wave Height (ft)	5.2
1% AEP Peak Wave Period(s)	5.2
1% AEP Overtopping Criterion (l/s/m)	200

A preliminary geometry for the storm surge barrier openings has been established and is shown in Figure 6-23. This geometry has been established based on the basis of design criteria as provided in Section 2 and include one navigable opening to accommodate navigation (see Annex A for establishing the minimum dimensions of the navigable opening) and two auxiliary flow gates to maintain tidal exchange to the fullest extent possible. The gate type selection for the navigable

passage as well as the auxiliary flow opening is documented in Annex A. The existing cross-sectional flow area below MSL at the proposed storm surge barrier location is approximately 15,300 ft². The aggregated flow opening area provided within the conceptual design is 7,900 ft² (approximately 52% of the existing flow area at that location). This preliminary geometry is under evaluation with the use of hydrodynamic and ecological modeling (USACE ERDC, 2022).

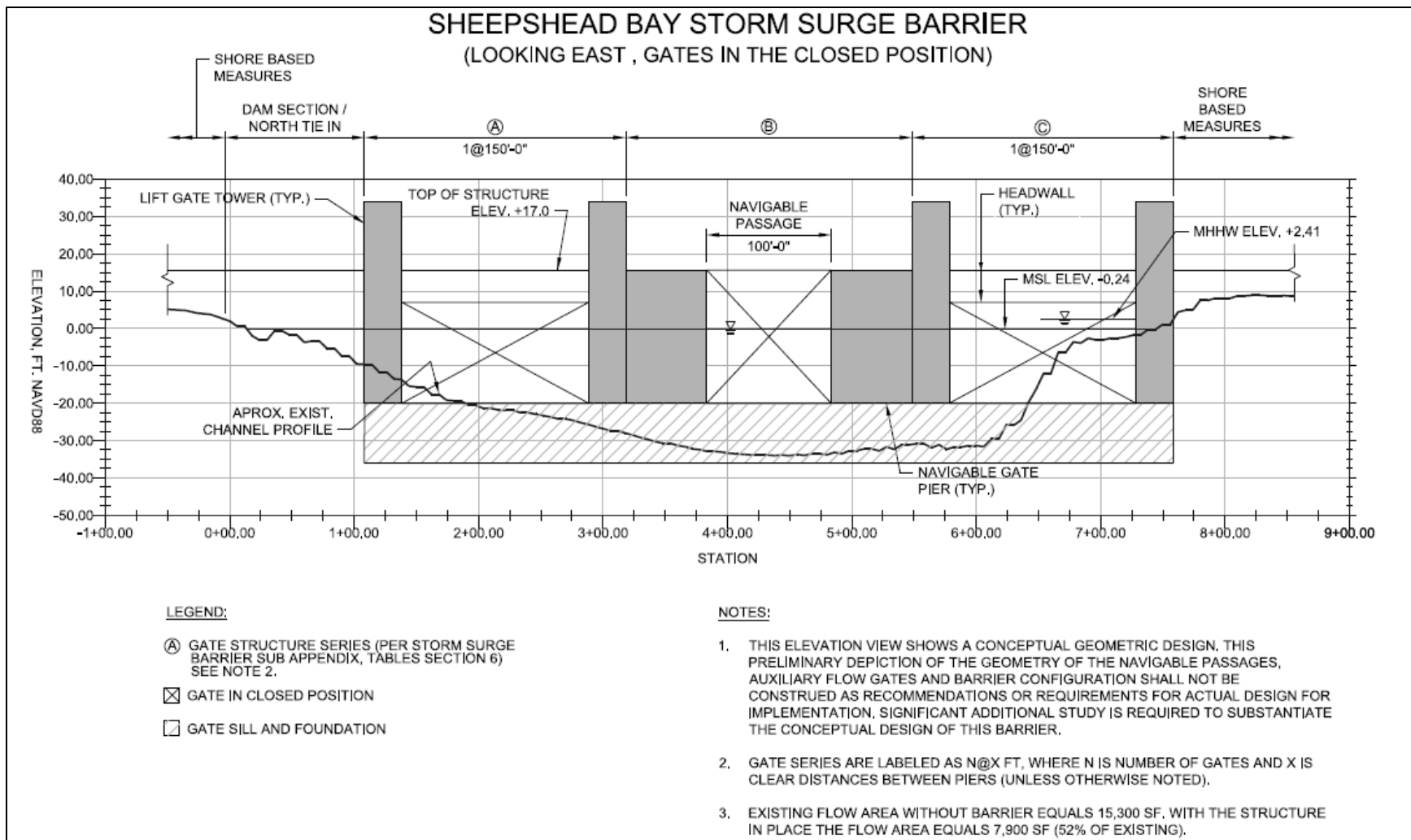

Figure 6-23: Conceptual Geometry of Gates of the Sheepshead Bay Storm Surge Barrier

Table 6-17: Summary of Sheepshead Bay Storm Surge Barrier Geometry – Navigable Passage and Auxiliary Flow Gates

Element (Gate Structure with Lettered ID)	No. Gates	Sill Elevation in ft NAVD88 (and in ft MLLW in parentheses)	Gate Width (ft)	Flow Area ¹ (ft ²)	Span ² (ft)	Note	Top of Structure (ft, NAVD88)	Gate Height (ft)	Top of Lift Gate in Raised Position ³ (ft, NAVD88)
A	1	-20	150	2,964	210	Auxiliary Flow Gate (Lift Gate)	+17	27	34
B	1	-20 (-18)	100	1,976	230	Navigable Passage (Sector Gate)	+17	37	N/A
C	1	-20	150	2,964	210	Auxiliary Flow Gate (Lift Gate)	+17	27	34
North Dam	0	N/A	N/A	0	120	Dam Section North Bank	+17	N/A	N/A
South Dam	0	N/A	N/A	0	0	Dam Section South Bank	+17	N/A	N/A
Total	3			7,904	770				

Notes:

1 Flow area measured from elevation MSL to sill.

2 The span for navigable structures equals gate width + pier widths. Pier widths equal 65% of gate width, and the span for auxiliary structures equals gate width plus pier widths (pier widths equal 30 ft).

3 Top of single leaf lift gate with headwall at +7 ft.

6.14 Gerritsen Creek

This section summarizes the key hydraulic and geometric parameters for the conceptual design of the Gerritsen Creek Storm Surge Barrier (Figure 6-24). Table 6-18 below summarizes the key environmental criteria from Section 3 that determine the elevation of the conceptual storm surge barrier design.

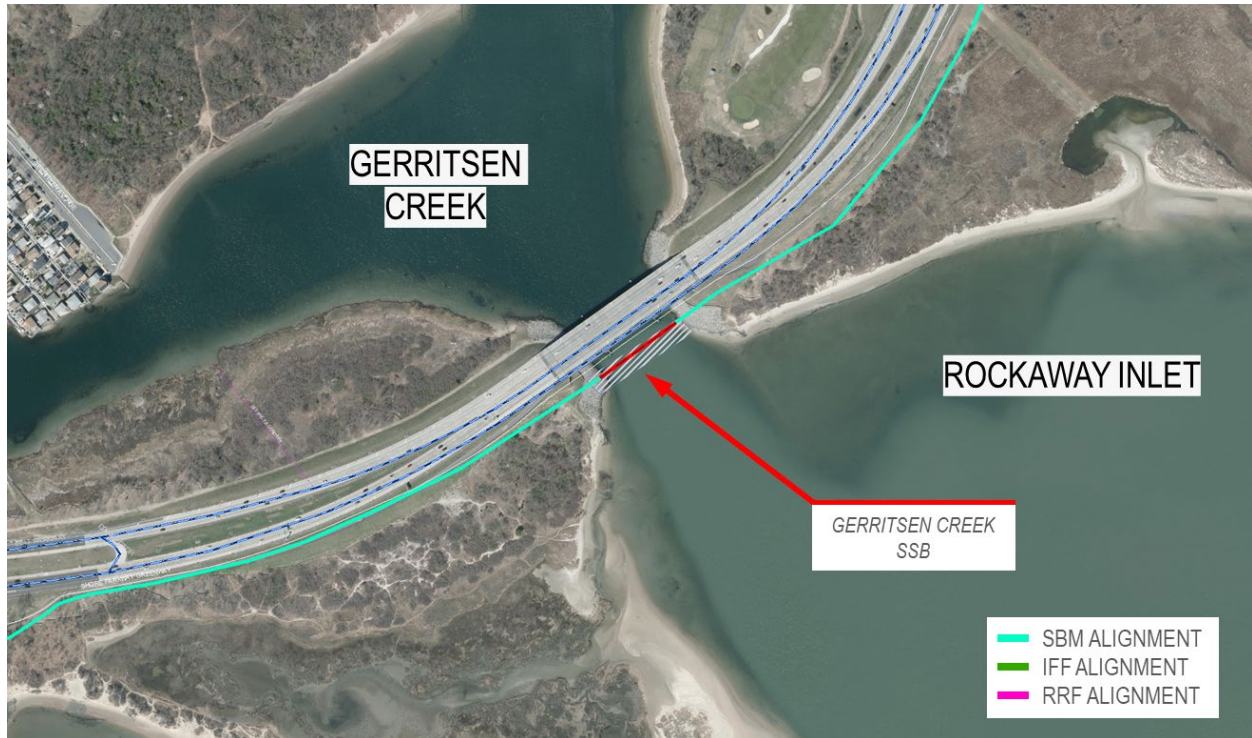

Figure 6-24: Gerritsen Creek Storm Surge Barrier Approximate Location

Table 6-18: Summary of Environmental Design Criteria (Gerritsen Creek)

Parameter	Value
RSLC for design life through 2095 (ft)	2.29
1% AEP Design Water Level (ft NAVD88) year 2095	12.2
1% AEP Significant Wave Height (ft)	4.0
1% AEP Peak Wave Period(s)	3.6
1% AEP Overtopping Criterion (l/s/m)	200

A preliminary geometry for the storm surge barrier openings has been established and is shown in Figure 6-25. This geometry has been established based on the basis of design criteria as provided in Section 2 and includes one navigable opening to accommodate navigation (see Annex A for establishing the minimum dimensions of the navigable opening) and two auxiliary flow gates to maintain tidal exchange to the fullest extent possible. The gate type selection for the navigable

passage as well as the auxiliary flow opening is documented in Annex A. The existing cross-sectional flow area below MSL at the proposed storm surge barrier location is approximately 4,200 ft². The aggregated flow opening area provided within the conceptual design is 3,100 ft² (approximately 74% of the existing flow area at that location). This preliminary geometry is under evaluation with the use of hydrodynamic and ecological modeling (USACE ERDC, 2022).

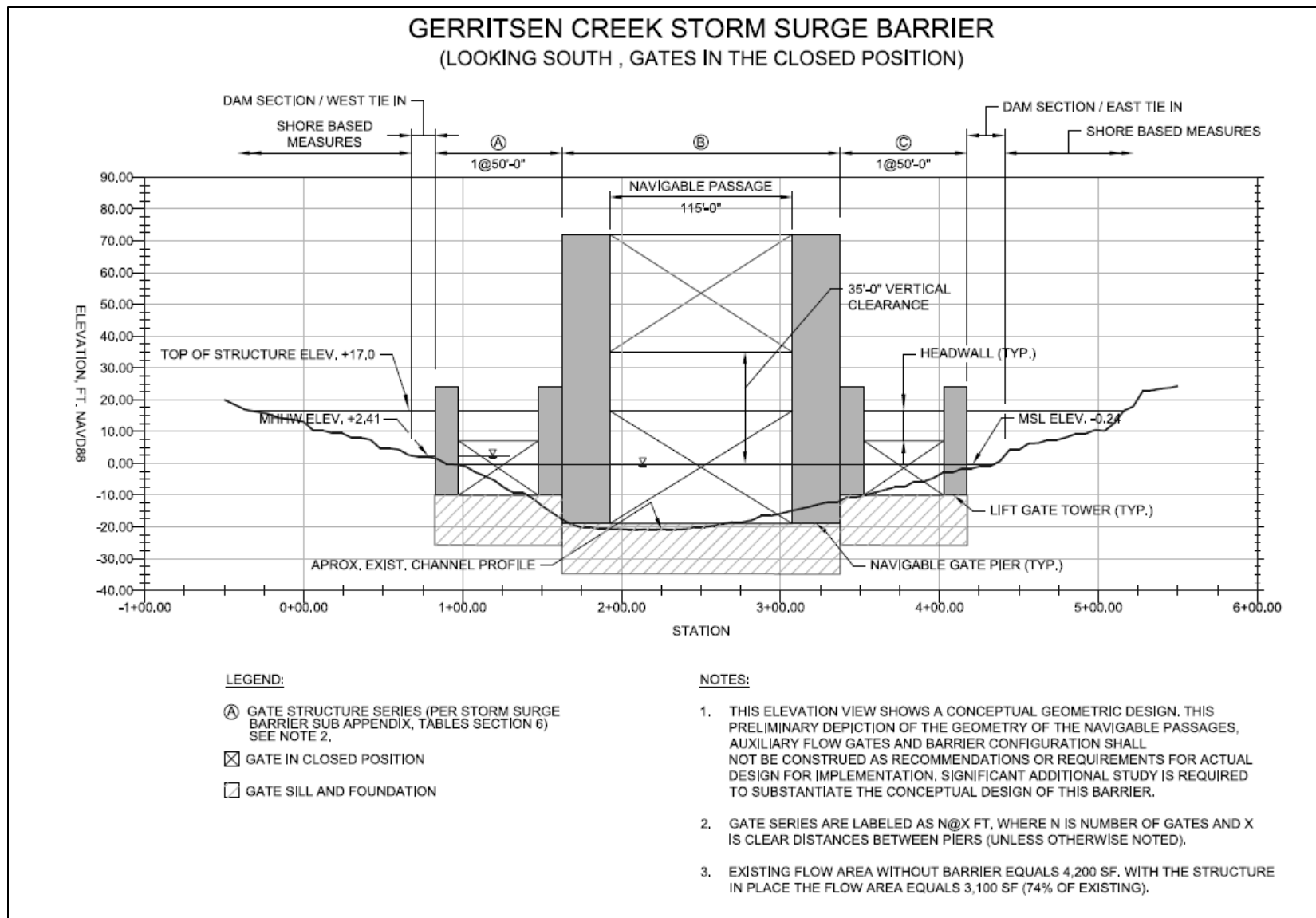

Figure 6-25: Conceptual Geometry of Gates of the Gerritsen Creek Storm Surge Barrier

Table 6-19: Summary of Gerritsen Creek Storm Surge Barrier Geometry – Navigable Passage and Auxiliary Flow Gates

Element (Gate Structure with Lettered ID)	No. Gates	Sill Elevation in ft NAVD88 (and in ft MLLW in parentheses)	Gate Width (ft)	Flow Area ¹ (ft ²)	Span ² (ft)	Notes	Top of Structure (ft, NAVD88)	Gate Height (ft)	Top of Lift Gate in Raised Position ³ (ft, NAVD88)
A	1	-10	50	488	80	Auxiliary Flow Gate (Lift Gate)	+17	17	24
B	1	-19 (-17)	115	2,157	175	Navigable Passage (Lift Gate)	+17	36	72
C	1	-10	50	488	80	Auxiliary Flow Gate (Lift Gate)	+17	17	24
West Dam	0	N/A	N/A	0	15	Dam Section West Bank	+17	N/A	N/A
East Dam	0	N/A	N/A	0	25	Dam Section East Bank	+17	N/A	N/A
Total	3			3,133	375				

Note

1 Flow area measured from elevation MSL to sill.

2 The span for navigable structures equals gate width + pier widths. Pier widths (each) equal 30 ft for navigable gate width, and the span for auxiliary structures equals gate width plus pier widths (pier widths equal 15 ft).

3 Top of single leaf lift gate with headwall at +7 ft.

6.15 Eastchester Creek

This section summarizes the key hydraulic and geometric parameters for the conceptual design of the Eastchester Creek storm surge barrier (Figure 6-26). Table 6-20 below summarizes the key environmental criteria from Section 3 that determine the elevation of the conceptual storm surge barrier design.



Figure 6-26: Eastchester Creek Storm Surge Barrier Approximate Location

Table 6-20: Summary of Environmental Design Criteria (East Chester Creek)

Parameter	Value
RSLC for design life through 2095 (ft)	1.74
1% AEP Design Water Level (ft NAVD88) year 2095	14.9
1% AEP Significant Wave Height (ft)	3.9
1% AEP Peak Wave Period(s)	3.5
1% AEP Overtopping Criterion (l/s/m)	200

A preliminary geometry for the storm surge barrier openings has been established and is shown in Figure 6-27. This geometry has been established based on the basis of design criteria as provided in Section 2 and include one navigable opening to accommodate navigation (see Annex A for

establishing the minimum dimensions of the navigable opening) and one auxiliary flow gate to maintain tidal exchange to the fullest extent possible. The gate type selection for the navigable passage as well as the auxiliary flow opening is documented in Annex A. The existing cross-sectional flow area at the proposed storm surge barrier location is approximately 7,400 ft². The aggregated flow opening area below MSL provided by the conceptual design is 2,100 ft² (approximately 27% of the existing flow area at that location). For East Chester Creek it should be noted that the storm surge barrier location is just downstream of an existing constriction, i.e., at the Pelham Parkway Bridge crossing. The existing flow area at the upstream bridge location is estimated at 6,000 ft² and the storm surge barrier provides approximately 35% of the existing flow area. This preliminary geometry is under evaluation with the use of hydrodynamic and ecological modeling (USACE ERDC, 2022).

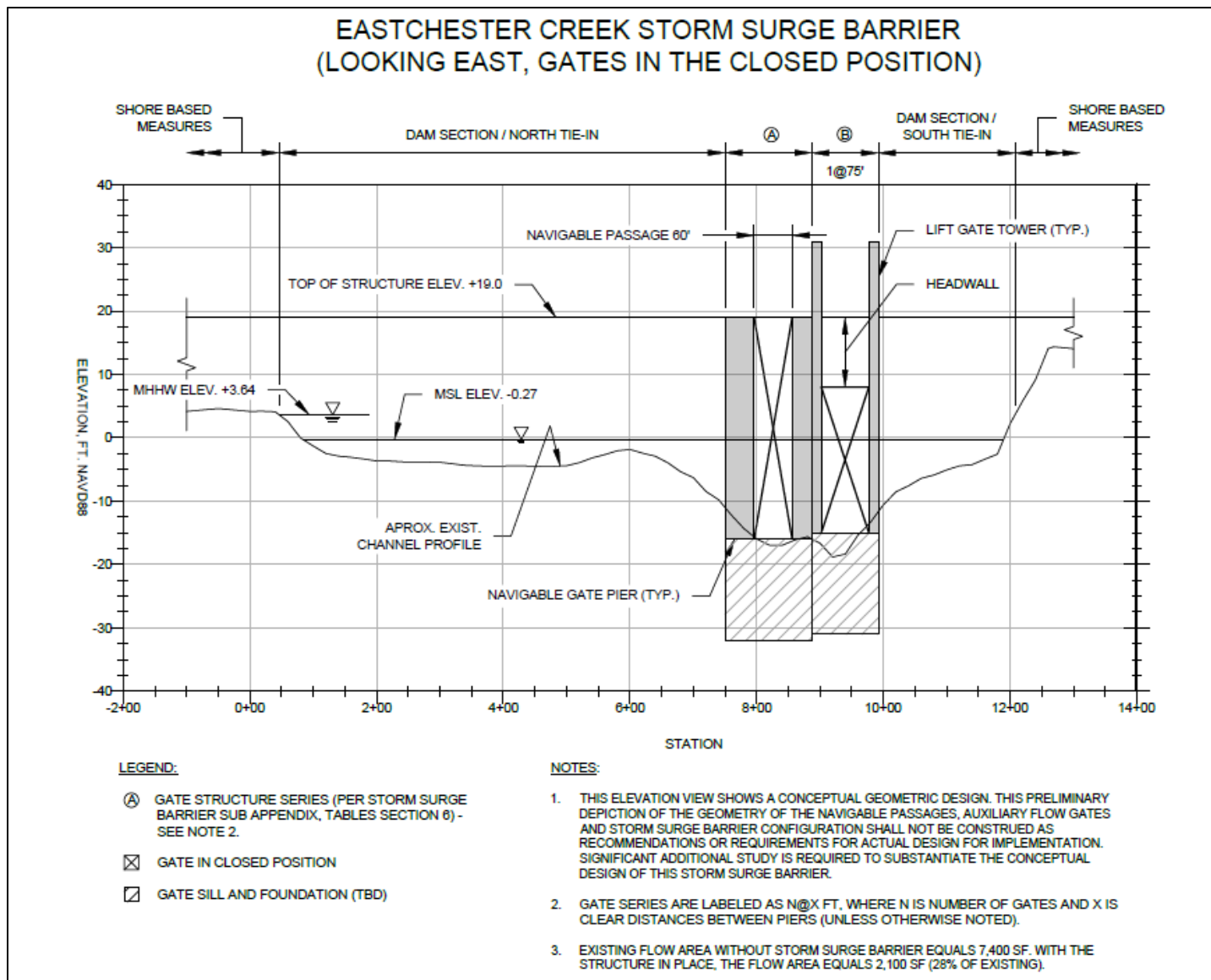

Figure 6-27: Conceptual Geometry of Gates of the East Chester Creek Storm Surge Barrier

Table 6-21: Summary of East Chester Creek Storm Surge Barrier Geometry – Navigable Passage and Auxiliary Flow Gates

Element ¹ (Gate Structure with Lettered ID)	No. Gates	Sill Elevation in ft NAVD88 (and in ft MLLW in parentheses)	Gate Width (ft)	Flow Area ¹ (ft ²)	Span ² (ft)	Notes	Top of Structure (ft, NAVD88)	Gate Height (ft)	Top of Lift Gate in Raised Position ³ (ft, NAVD88)
A	1	-16 (-12)	60	944	140	Navigable Passage (Sector Gate)	+19	35	N/A
B	1	-15	75	1,105	95	Auxiliary Flow Gate (Lift Gate)	+19	24	33
North Dam	0	N/A	N/A	0	850	Dam Section North Bank	+19	N/A	N/A
South Dam	0	N/A	N/A	0	300	Dam Section South Bank	+19	N/A	N/A
Total	2			2,049	1,385				

Notes:

1 Flow area measured from elevation MSL to sill.

2 The span for navigable structures equals gate width + pier widths. Pier widths equal 65% of gate width, and the span for auxiliary structures equals gate width plus pier widths.

3 Top of single leaf lift gate with headwall at +9 ft.

6.16 Port Washington

This section summarizes the key hydraulic and geometric parameters for the conceptual design of the Port Washington Storm Surge Barrier (Figure 6-28). Table 6-22 below summarizes the key environmental criteria from Section 2 that determine the elevation of the conceptual storm surge barrier design.



Figure 6-28: Port Washington Storm Surge Barrier Approximate Location

Table 6-22: Summary of Environmental Design Criteria (Port Washington)

Parameter	Value
RSLC for design life through 2095 (ft)	1.74
1% AEP Design Water Level (ft NAVD88) year 2095	15.1
1% AEP Significant Wave Height (ft)	4.3
1% AEP Peak Wave Period(s)	5.6
1% AEP Overtopping Criterion (l/s/m)	200

A preliminary geometry for the storm surge barrier openings has been established and is shown in Table 6-23. This geometry has been established based on the basis of design criteria as provided in Section 2 and includes one navigable opening to accommodate navigation (see Annex A for

establishing the minimum dimensions of the navigable opening) and a maximum number of auxiliary flow gates to maintain tidal exchange to the fullest extent possible. The gate type selection for the navigable passage as well as the auxiliary flow opening is documented in Annex A. The existing cross-sectional flow area at the proposed storm surge barrier location is approximately 2,100 ft². The aggregated flow opening area below MSL provided by the conceptual design is 5,400 ft² (approximately 257% of the existing flow area at that location). This preliminary geometry is under evaluation with the use of hydrodynamic and ecological modeling (USACE ERDC, 2022).

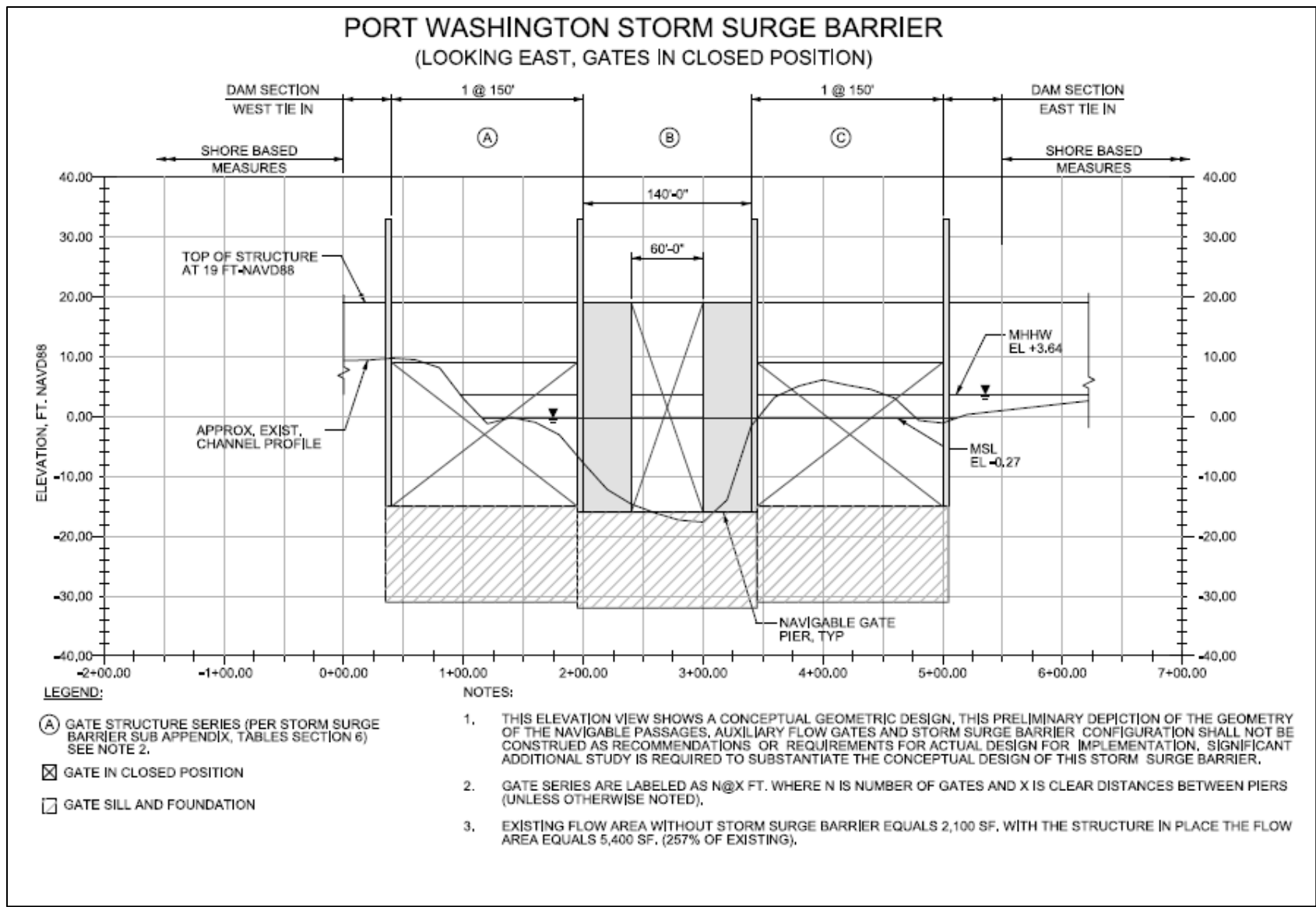

Figure 6-29: Conceptual Geometry of Gates of the Port Washington Storm Surge Barrier

Table 6-23: Summary of Port Washington Storm Surge Barrier Geometry – Navigable Passage and Auxiliary Flow Gates

Element ¹ (Gate Structure with Lettered ID)	No. Gates	Sill Elevation in ft NAVD88 (and in ft MLLW in parentheses)	Gate Width (ft)	Flow Area ¹ (ft ²)	Span ² (ft)	Notes	Top of Structure (ft, NAVD88)	Gate Height (ft)	Top of Lift Gate in Raised Position ³ (ft, NAVD88)
A	1	-15	150	2,214	160	Lift Gate	+19	24	33
B	1	-16 (-14)	60	946	140	Navigable Passage (Sector Gate)	+19	35	N/A
C	1	-15	150	2,214	160	Lift Gate	+19	24	33
East Dam	0	N/A	N/A	0	100	Dam Section East Bank	+19	N/A	N/A
West Dam	0	N/A	N/A	0	100	Dam Section West Bank	+19	N/A	N/A
Total	3			5,374	660				

Notes

1 Flow area measured from elevation MSL to sill.

2 The span for navigable structures equals gate width + pier widths. Pier widths equal 65% of gate width, and the span for auxiliary structures equals gate width plus pier widths.

3 Top of single leaf lift gate with headwall at +9 ft.

6.17 Hempstead Harbor (Glen Cove)

This section summarizes the key hydraulic and geometric parameters for the conceptual design of the Hempstead Harbor Storm Surge Barrier (Figure 6-30). Table 6-24 below summarizes the key environmental criteria from Section 2 that determine the elevation of the conceptual storm surge barrier design.



Figure 6-30: Hempstead Harbor (Glen Cove) Storm Surge Barrier Approximate Location

Table 6-24: Summary of Environmental Design Criteria (Hempstead Harbor)

Parameter	Value
RSLC for design life through 2095 (ft)	1.74
1% AEP Design Water Level (ft NAVD88) year 2095	15.1
1% AEP Significant Wave Height (ft)	4.3
1% AEP Peak Wave Period(s)	5.6
1% AEP Overtopping Criterion (l/s/m)	200

A preliminary geometry for the storm surge barrier openings has been established and is shown in Figure 6-31. This geometry has been established based on the basis of design criteria as provided in Section 2 and includes one navigable opening to accommodate navigation (see Annex A for establishing the minimum dimensions of the navigable opening). The gate type selection for the navigable passage is documented in Annex A. The existing cross-sectional flow area at the proposed storm surge barrier location is approximately 700 ft². The aggregated flow opening area

below MSL provided by the conceptual design is 600 ft² (approximately 86% of the existing flow area at that location). This preliminary geometry is under evaluation with the use of hydrodynamic and ecological modeling (USACE ERDC, 2022).

HEMPSTEAD HARBOR (GLEN COVE) STORM SURGE BARRIER (LOOKING EAST, GATES IN CLOSED POSITION)

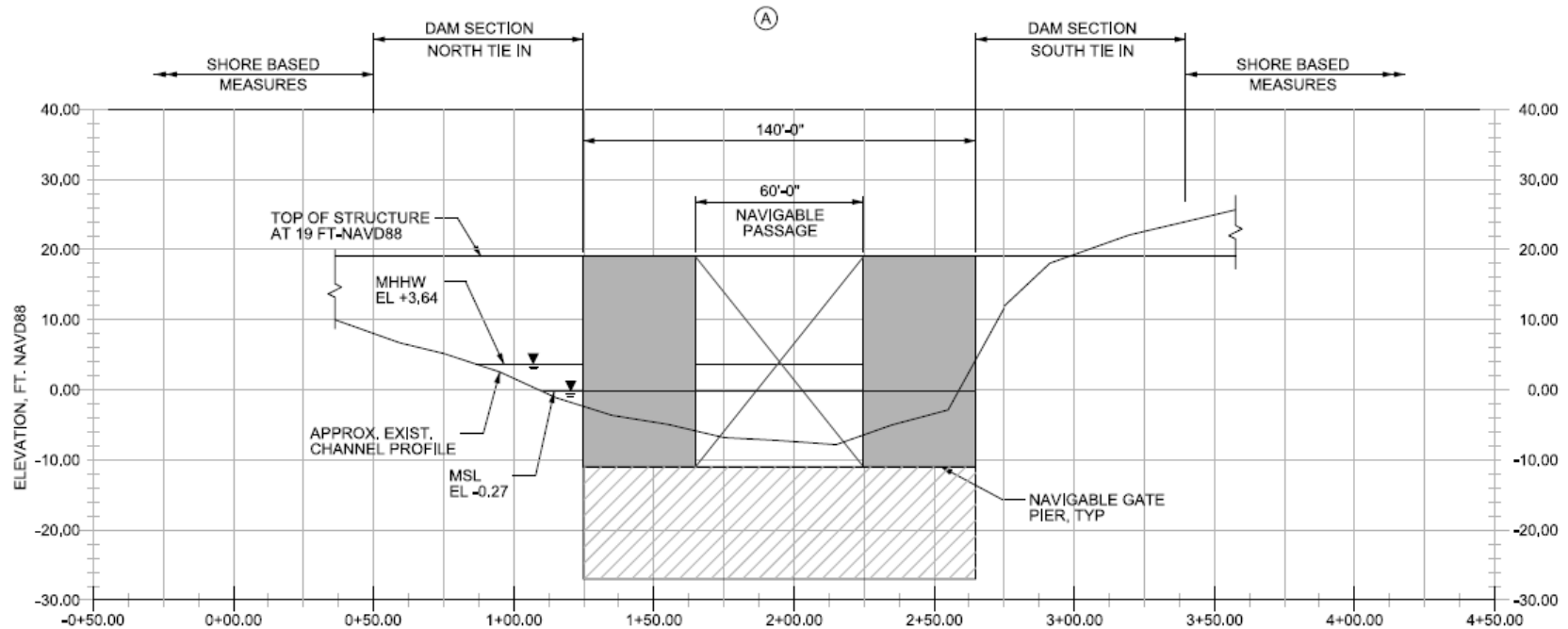

LEGEND:

- (A) GATE STRUCTURE SERIES (PER STORM SURGE BARRIER SUB APPENDIX, TABLES SECTION 6) SEE NOTE 2.
- ☒ GATE IN CLOSED POSITION
- ▨ GATE SILL AND FOUNDATION

NOTES:

1. THIS ELEVATION VIEW SHOWS A CONCEPTUAL GEOMETRIC DESIGN, THIS PRELIMINARY DEPICTION OF THE GEOMETRY OF THE NAVIGABLE PASSAGES, AUXILIARY FLOW GATES AND STORM SURGE BARRIER CONFIGURATION SHALL NOT BE CONSTRUED AS RECOMMENDATIONS OR REQUIREMENTS FOR ACTUAL DESIGN FOR IMPLEMENTATION, SIGNIFICANT ADDITIONAL STUDY IS REQUIRED TO SUBSTANTIATE THE CONCEPTUAL DESIGN OF THIS STORM SURGE BARRIER.
2. GATE SERIES ARE LABELED AS N@X FT. WHERE N IS NUMBER OF GATES AND X IS CLEAR DISTANCES BETWEEN PIERS (UNLESS OTHERWISE NOTED).
3. EXISTING FLOW AREA WITHOUT STORM SURGE BARRIER EQUALS 700 SF. WITH THE STRUCTURE IN PLACE THE FLOW AREA EQUALS 600 SF. (86% OF EXISTING).

Figure 6-31: Conceptual Geometry of Gates of the Hempstead Harbor Storm Surge Barrier

Table 6-25: Summary of Hempstead Harbor (Glen Cove) Storm Surge Barrier Geometry – Navigable Passage

Element¹ (Gate Structure with Lettered ID)	No. Gates	Sill Elevation in ft NAVD88 (and in ft MLLW in parentheses)	Gate Width (ft)	Flow Area¹ (ft²)	Span² (ft)	Notes	Top of Structure (ft, NAVD88)	Gate Height (ft)	Top of Lift Gate in Raised Position³ (ft, NAVD88)
A	1	-11 (-9)	60	646	140	Navigable Passage (Sector Gate)	+19	30	N/A
East Dam	0	N/A	N/A	0	70	Dam Section East Bank	+19	N/A	N/A
West Dam	0	N/A	N/A	0	70	Dam Section West Bank	+19	N/A	N/A
Total	1			646	280				

Notes

1 Flow area measured from elevation MSL to sill.

2 The span for navigable structures equals gate width + pier widths. Pier widths equal 40 ft.

6.18 Hammond Creek

This section summarizes the key hydraulic and geometric parameters for the conceptual design of the Hammond Creek Storm Surge Barrier (Figure 6-32). Table 6-26 below summarizes the key environmental criteria from Section 2 that determine the elevation of the conceptual storm surge barrier design.



Figure 6-32: Hammond Creek Storm Surge Barrier Approximate Location

Table 6-26: Summary of Environmental Design Criteria (Hammond Creek)

Parameter	Value
RSLC for design life through 2095 (ft)	1.74
1% AEP Design Water Level (ft NAVD88) year 2095	15.1
1% AEP Significant Wave Height (ft)	4.3
1% AEP Peak Wave Period(s)	5.6
1% AEP Overtopping Criterion (l/s/m)	200

A preliminary geometry for the storm surge barrier openings has been established and is shown in Figure 6-33. This geometry has been established based on the basis of design criteria as provided in Section 2 and includes one navigable opening to accommodate navigation (see Annex A for establishing the minimum dimensions of the navigable opening). The gate type selection for the navigable passage is documented in Annex A. The existing cross-sectional flow area at the

proposed storm surge barrier location is approximately 1,300 ft². The aggregated flow opening area below MSL provided by the conceptual design is 900 ft² (approximately 69% of the existing flow area at that location). This preliminary geometry is under evaluation with the use of hydrodynamic and ecological modeling (USACE ERDC, 2022).

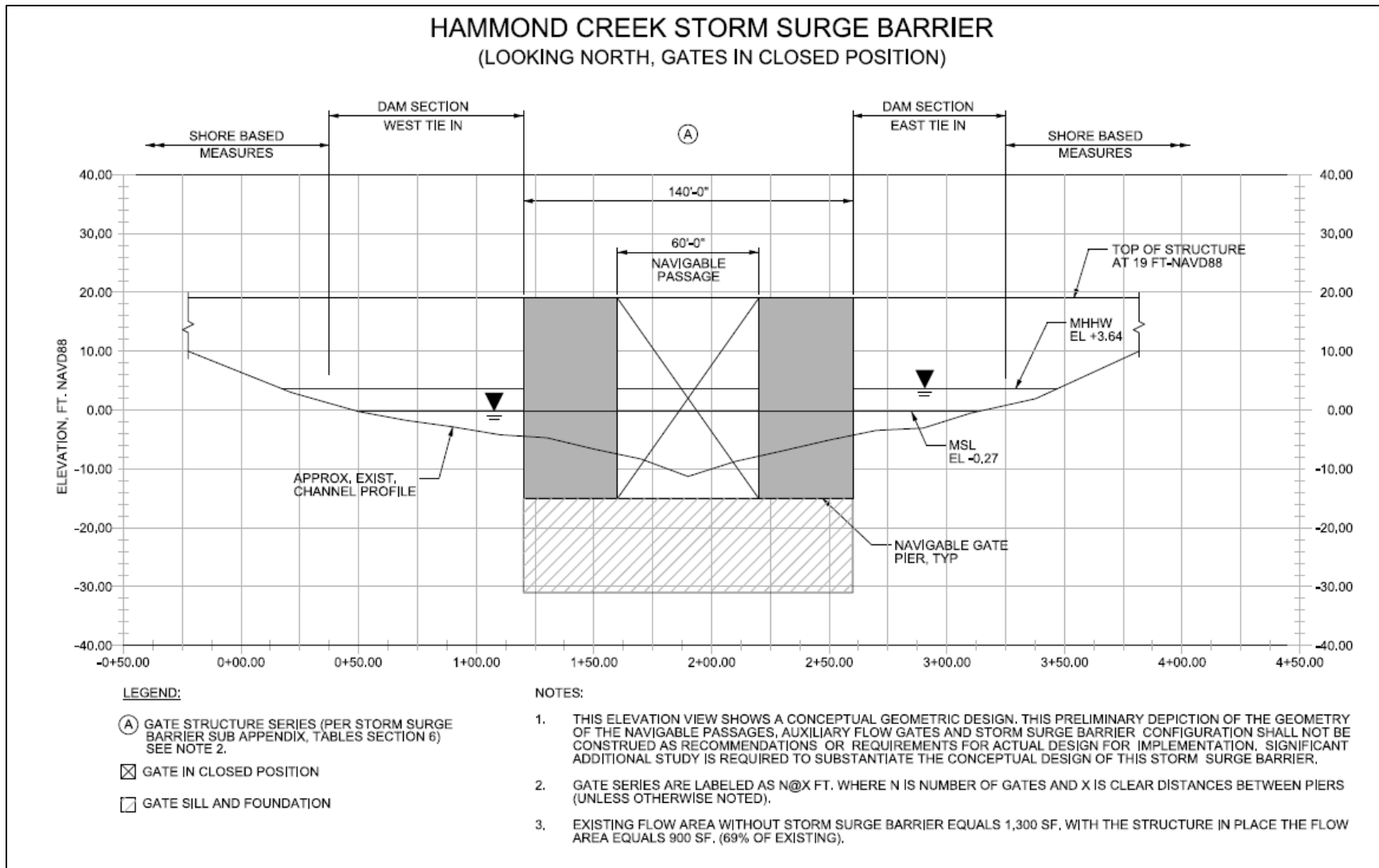

Figure 6-33: Conceptual Geometry of Gates of the Hammond Creek Storm Surge Barrier

Table 6-27: Summary of Hammond Creek Storm Surge Barrier Geometry – Navigable Passage and Auxiliary Flow Gates

Element ¹ (Gate Structure with Lettered ID)	No. Gates	Sill Elevation in ft NAVD88 (and in ft MLLW in parentheses)	Gate Width (ft)	Flow Area ¹ (ft ²)	Span ² (ft)	Notes	Top of Structure (ft, NAVD88)	Gate Height (ft)	Top of Lift Gate in Raised Position ³ (ft, NAVD88)
A	1	-15 (-13)	60	886	.81	Navigable Passage (Sector Gate)	+19	34	N/A
East Dam	0	N/A	N/A	0	80	Dam Section East Bank	+19	N/A	N/A
West Dam	0	N/A	N/A	0	80	Dam Section West Bank	+19	N/A	N/A
Total	1			886	230				

Notes

1 Flow area measured from elevation MSL to sill.

2 The span for navigable structures equals gate width + pier widths. Pier widths equal 40 ft.

6.19 Highlands

This section summarizes the key hydraulic and geometric parameters for the conceptual design of the Highlands Storm Surge Barrier. Table 6-28 below summarizes the key environmental criteria from Section 2 that determine the elevation of the conceptual storm surge barrier design.



Figure 6-34: Highlands Storm Surge Barrier Approximate Location

Table 6-28: Summary of Environmental Design Criteria (Highlands Storm Surge Barrier)

Parameter	Value
RSLC for design life through 2095 (ft)	2.29
1% AEP Design Water Level (ft NAVD88) year 2095	13.7
1% AEP Significant Wave Height (ft)	16.1
1% AEP Peak Wave Period(s)	14.1
1% AEP Overtopping Criterion (l/s/m)	200

A preliminary geometry for the storm surge barrier openings has been established and is shown in Figure 6-35. This geometry has been established based on the basis of design criteria as provided in Section 2 and includes one navigable opening to accommodate navigation (see Annex A for establishing the minimum dimensions of the navigable opening) and a maximum number of

auxiliary flow gates to maintain tidal exchange to the fullest extent possible. The gate type selection for the navigable passage as well as the auxiliary flow openings is documented in Annex A. The existing cross-sectional flow area at the proposed storm surge barrier location is approximately 47,900 ft². The aggregated flow opening area below MSL provided by the conceptual design is 22,600 ft² (approximately 47% of the existing flow area at that location). This preliminary geometry is under evaluation with the use of hydrodynamic and ecological modeling (USACE ERDC, 2022).

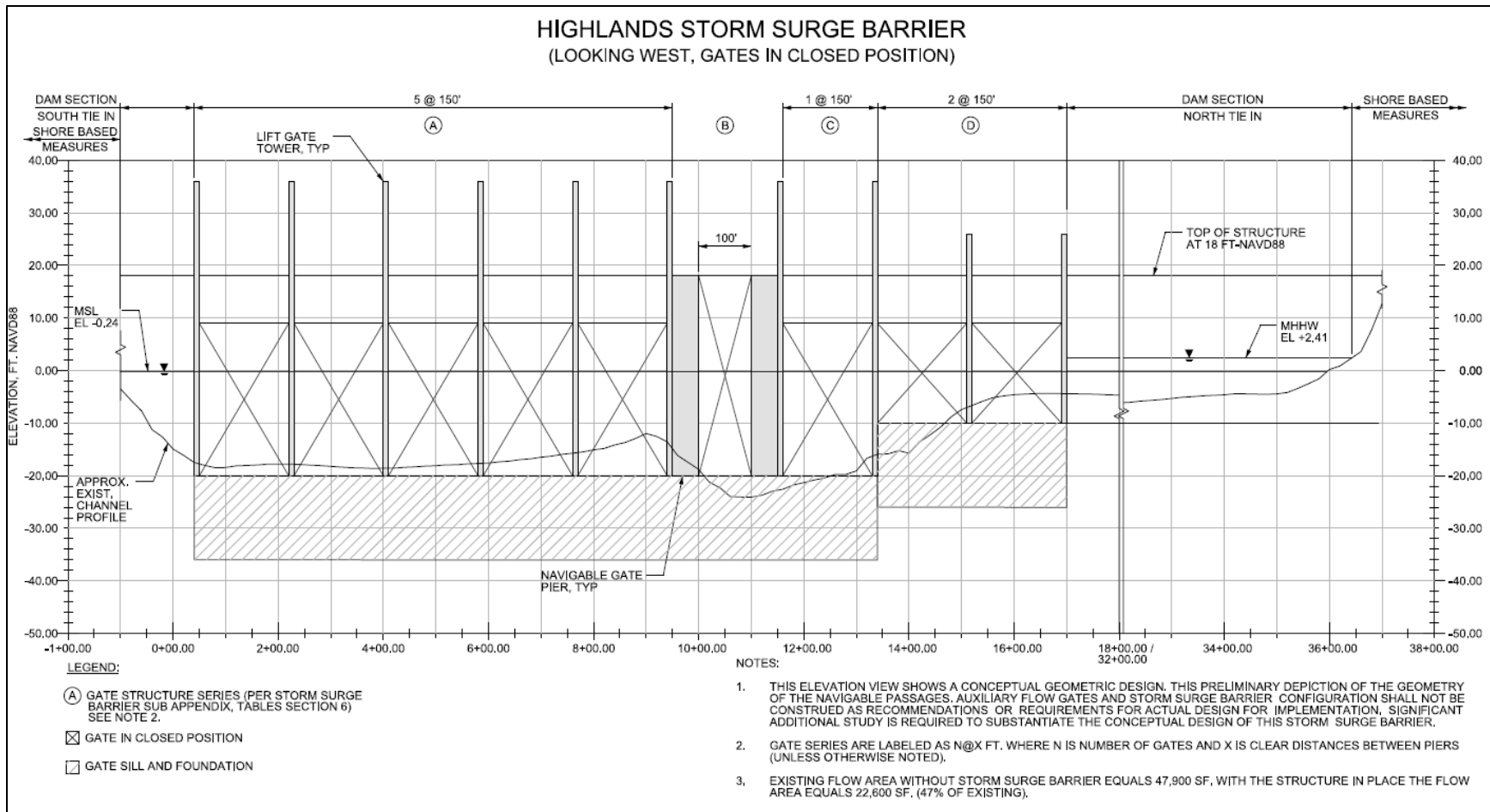

Figure 6-35: Conceptual Geometry of Gates of the Highlands Storm Surge Barrier

Table 6-29: Summary of Highlands Storm Surge Barrier Geometry – Navigable Passage and Auxiliary Flow Gates

Element ¹ (Gate Structure with Lettered ID)	No. Gates	Sill Elevation in ft NAVD88 (and in ft MLLW in parentheses)	Gate Width Gate (ft)	Flow Area ¹ (ft ²)	Span ² (ft)	Notes	Top of Structure (ft, NAVD88)	Gate Height (ft)	Top of Lift Gate in Raised Position ³ (ft, NAVD88)
A	5	-20	150	14,820	800	Auxiliary Flow Gate (Lift Gate)	+18	28	36
B	1	-20	100	1,976	250	Auxiliary Flow Gate (Lift Gate)	+18	38	N/A
C	1	-20 (-18)	150	2,964	160	Navigable Passage (Sector Gate)	+18	28	36
D	2	-10	150	2,928	320	Auxiliary Flow Gate (Lift Gate)	+18	18	26
North Dam	0	N/A	N/A	0	2,200	Dam Section North Bank	+18	N/A	N/A
South Dam	0	N/A	N/A	0	150	Dam Section South Bank	+18	N/A	N/A
Total	9			22,688	3,880				

Notes

1 Flow area measured from elevation MSL to sill.

2 The span for navigable structures equals gate width + pier widths. Pier widths equal 10 ft for auxiliary structures.

3 Top of single leaf lift gate with headwall at +8 ft.

6.20 Raritan River

This section summarizes the key hydraulic and geometric parameters for the conceptual design of the Raritan River Storm Surge Barrier. Table 6-30 below summarizes the key environmental criteria from Section 2 that determine the elevation of the conceptual storm surge barrier design.



Figure 6-36: Raritan River Storm Surge Barrier Approximate Location

Table 6-30: Summary of Environmental Design Criteria (Raritan River)

Parameter	Value
RSLC for design life through 2095 (ft)	2.3
1% AEP Design Water Level (ft NAVD88) year 2095	13.4
1% AEP Significant Wave Height (ft)	6.0
1% AEP Peak Wave Period(s)	6.2
1% AEP Overtopping Criterion (l/s/m)	200

A preliminary geometry for the storm surge barrier openings has been established and is shown in Figure 6-37. This geometry has been established based on the basis of design criteria as provided in Section 2 and includes one navigable opening to accommodate navigation (see Annex A for establishing the minimum dimensions of the navigable opening) and a maximum number of

auxiliary flow gates to maintain tidal exchange to the fullest extent possible. The gate type selection for the navigable passage as well as the auxiliary flow openings is documented in Annex A. The existing cross-sectional flow area at the proposed storm surge barrier location is approximately 13,800 ft². The aggregated flow opening area below MSL provided by the conceptual design is 15,700 ft² (approximately 114% of the existing flow area at that location). This preliminary geometry is under evaluation with the use of hydrodynamic and ecological modeling (USACE ERDC, 2022).

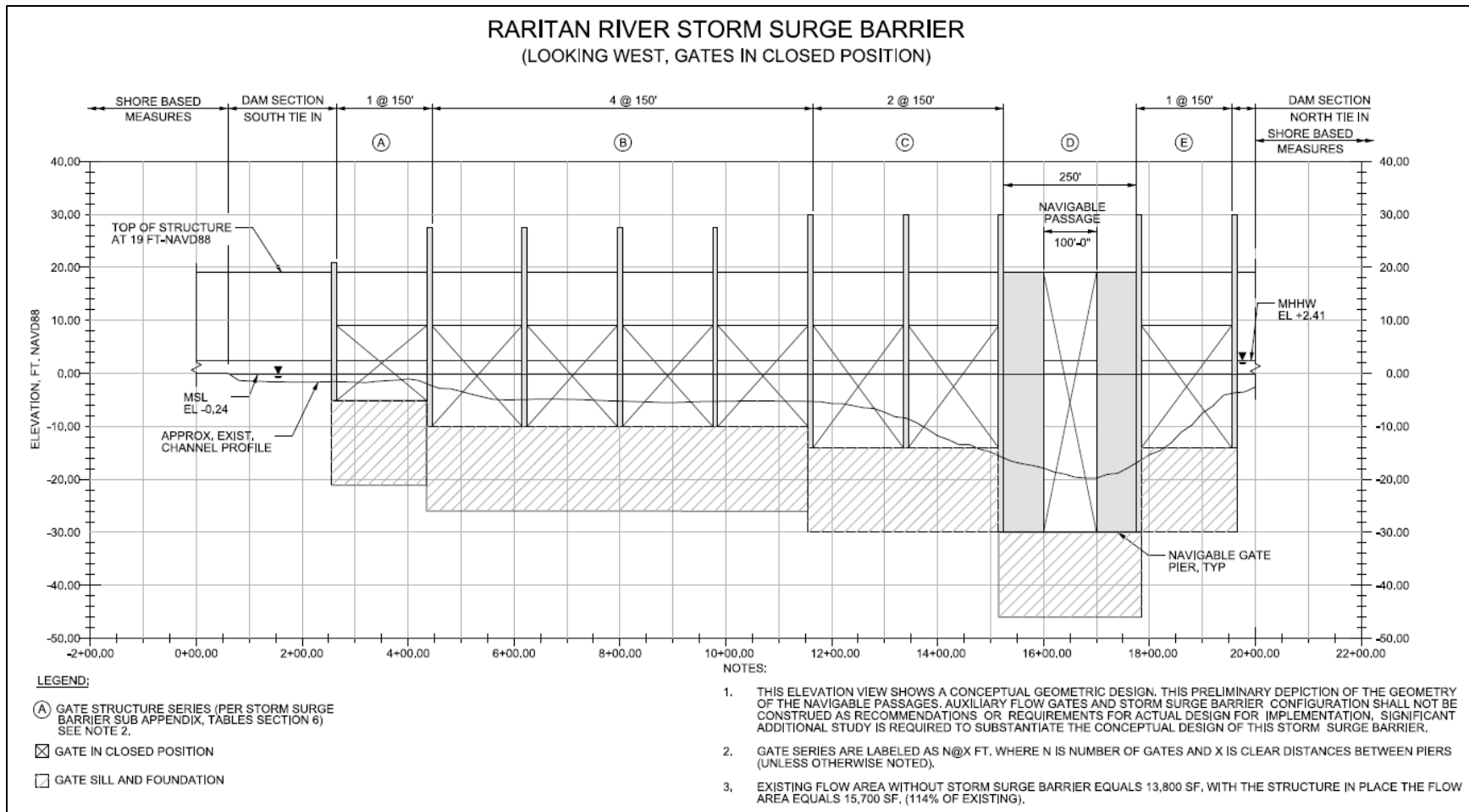

Figure 6-37: Conceptual Geometry of Gates of the Raritan River Storm Surge Barrier

Table 6-31: Summary of Raritan River Storm Surge Barrier Geometry – Navigable Passage and Auxiliary Flow Gates

Element ¹ (Gate Structure with Lettered ID)	No. Gates	Sill Elevation in ft NAVD88 (and in ft MLLW in parentheses)	Gate Width (ft)	Flow Area ¹ (ft ²)	Span ² (ft)	Notes	Top of Structure (ft, NAVD88)	Gate Height (ft)	Top of Lift Gate in Raised Position ³ (ft, NAVD88)
A	1	-5	150	714	160	Auxiliary Flow Gate (Lift Gate)	+19	13	21
B	4	-10	150	5,856	640	Auxiliary Flow Gate (Lift Gate)	+19	18	26
C	2	-14	150	4,128	320	Auxiliary Flow Gate (Lift Gate)	+19	22	30
D	1	-30 (-27)	100	2,976	250	Navigable Passage (Sector Gate)	+19	49	N/A
E	1	-14	150	2,064	160	Auxiliary Flow Gate (Lift Gate)	+19	22	30
North Dam	0	N/A	N/A	0	130	Dam Section North Bank	+19	N/A	N/A
South Dam	0	N/A	N/A	0	200	Dam Section South Bank	+19	N/A	N/A
Total	9			15,738	1,860				

Notes

1 Flow area measured from elevation MSL to sill.

2 The span for navigable structures equals gate width + pier widths. Pier widths equal 10 ft for auxiliary structures.

3 Top of single leaf lift gate with headwall at +8 ft.

7 Navigable Barriers as Risk Reduction Features (RRFs)

7.1 Introduction

Where storm surge barriers are proposed (Alternatives 2, 3A, 3B, and 4), complementary RRFs to manage the risk of more frequent flooding are proposed for developed, non-natural areas. The RRF alignments mitigate residual flood risk (up to the +7 feet NAVD88 flood level) under the assumption that the storm surge barrier (SSB) closure criterion is El. +7 feet NAVD88. The development of the alignments and the RRF designs are discussed in the SBM Sub-appendix. Specifically, RRFs are only considered in the basins enclosed by the six large storm surge barrier complexes as indicated in Table 7-1.

The need for RRFs is directly correlated to the assumed ability to operate storm surge barriers frequently, or infrequently. For the larger storm surge barrier structures that accommodate deep-draft navigation or intersect major shipping routes the operational frequency is expected to be substantially constrained. This is indicated by strict constrained operation (SCO) in the last column in the table below, i.e., the storm surge barrier gates will only be closed for the more severe coastal storm events such that navigation is not negatively impacted. The residual flood risk for the coastal areas upstream of the other storm surge barriers is mitigated by a lower closure elevation, i.e., operation is only moderately constraint (MCO) and more frequent operation is assumed to be possible, or the flood risk is minimal for the elevation of +7 feet NAVD88 due to natural relief. A more detailed evaluation of the frequency of operation and associated AEP event for a closure criterion for both SCO and MCO is provided in Section 2.6.2.1.

Table 7-1: SSB Summary for NYNJHAT Study Alternatives

Name	Alt. 2	Alt. 3A	Alt. 3B	Alt. 4	Alt. 5	RRFs in Basin	Constrained Operation ¹
Outer Harbor	YES					Yes	SCO
Throgs Neck	YES	YES				Yes	SCO
Verrazzano Narrows		YES				Yes	SCO
Arthur Kill		YES	YES			Yes	SCO
Jamaica Bay		YES	YES	YES		Yes	SCO
Kill Van Kull			YES			Yes	SCO
Hackensack River				YES		No	MCO
Newtown Creek			YES	YES		No	MCO
Gowanus Canal			YES	YES		No	MCO
Flushing Creek			YES	YES		No	MCO
Sheepshead Bay		YES	YES	YES		No	MCO
Gerritsen Creek		YES	YES	YES		No	MCO

Name	Alt. 2	Alt. 3A	Alt. 3B	Alt. 4	Alt. 5	RRFs in Basin	Constrained Operation ¹
Eastchester Creek	YES	YES				No	MCO
Port Washington	YES	YES				No	MCO
Hempstead Harbor	YES	YES				No	MCO
Hammond Creek	YES	YES				No	MCO
Highlands		YES				No	MCO
Raritan River		YES				No	MCO

Note:

1 Strict Constrained Operation (SCO) or Moderately Constrained Operation (MCO)

RRFs are typically small floodwalls and berms, amongst others, but at a few specific instances RRFs are proposed to cross existing waterways that are navigable. For these locations (as shown in Table 7-2 a navigable gate was assumed to be a cost-effective alternative to many miles of land based RRF features along the water's edge to reduce the risk of residual flooding. RRFs are only considered in the basins enclosed by the six large storm surge barrier complexes as indicated in Table 1-2. The residual flood risk for the coastal areas upstream of the other storm surge barriers is mitigated by a lower closure elevation (i.e., more frequent operation of the SSB) or the flood risk is minimal for the elevation of +7 feet NAVD88 due to natural relief.

Table 7-2: Navigable Gates as RRFs for NYNJHAT study alternatives

Name	Abbr.	Type	Alt. 2	Alt. 3A	Alt. 3B	Alt. 4	Alt. 5
Hackensack River RRF	HR RRF	RRF Nav. Gate Complex	YES	YES	YES		
Newtown Creek RRF	NC RRF	RRF Nav. Gate Complex	YES	YES			
Gowanus Canal RRF	GC RRF	RRF Nav. Gate Complex	YES	YES			
Sandy Hook Bridge RRF	SHB RRF	RRF Nav. Gate Complex	YES				
Head of Bay Gate RRF	HB RRF	RRF Nav. Gate Complex	YES				
Old Howard Beach East Gate RRF	OHBE RRF	RRF Nav. Gate Complex	YES	YES	YES	YES	
Old Howard Beach West Gate RRF	OHBW RRF	RRF Nav. Gate Complex	YES	YES	YES	YES	

7.2 Hackensack River RRF

This section summarizes the key hydraulic and geometric parameters for the conceptual design of the Hackensack River navigable barrier risk reduction feature. The RRF Navigable Gate complex is proposed to be located at the same location as the Hackensack River SSB as discussed under Section 5. For a design water level of +7 feet NAVD88 the crest elevation has been set at +10 feet

NAVD88 (see also Section 2.7.11). A preliminary geometry for the RRF navigable gate openings has been established and is shown in Figure 7-10. This geometry has been established based on the design of the Hackensack SSB and the conceptual design is largely the same with the exception of the crest elevation and the omission of a headwall. These key differences then also result in different gate heights when comparing the Hackensack River SSB with the Hackensack River RRF Navigable Gate. This preliminary geometry is under evaluation with the use of hydrodynamic and ecological modeling (USACE ERDC, 2022).

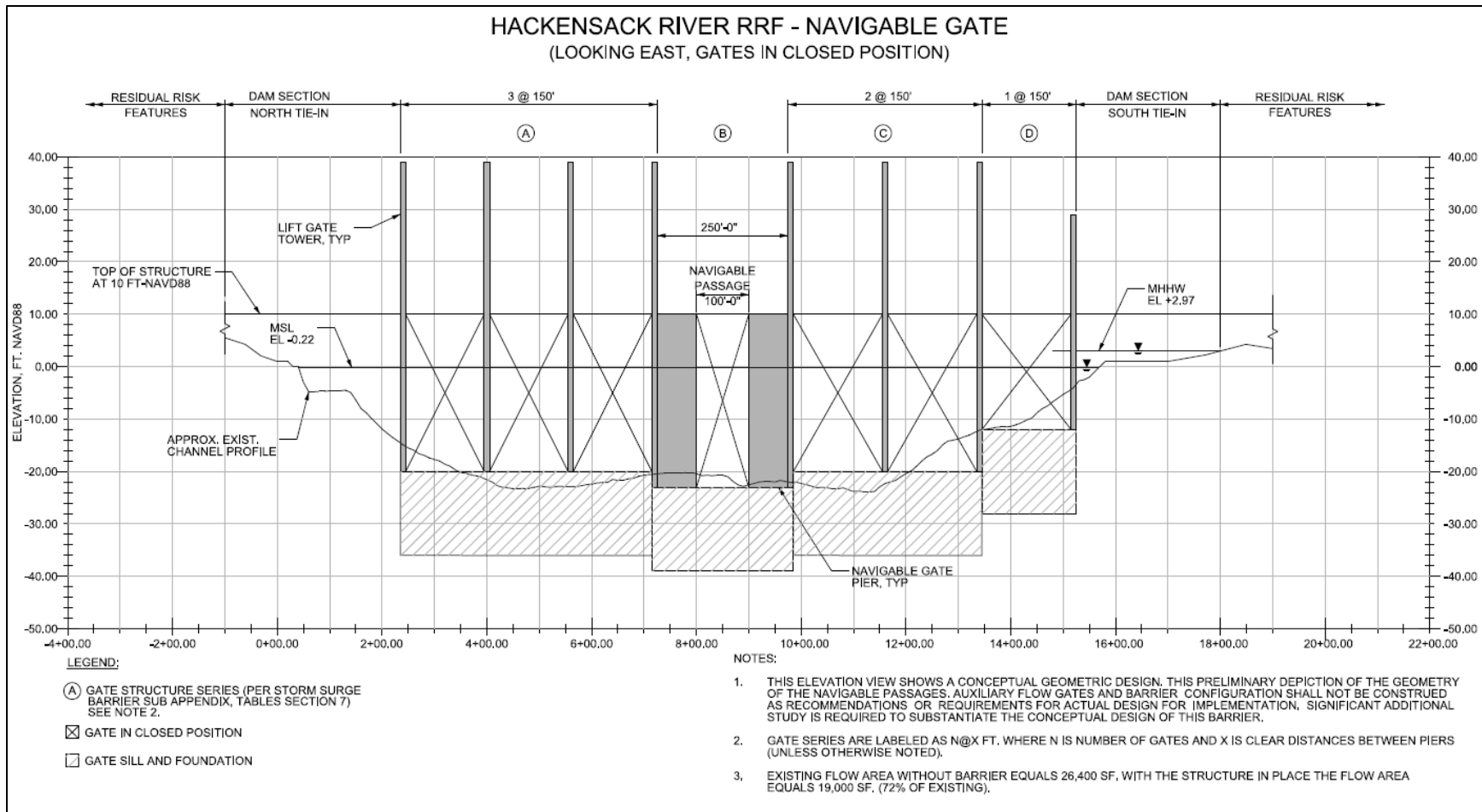

Figure 7-1: Conceptual Geometry of Gates of the Hackensack River RRF Navigable Gate

Table 7-3: Summary of Hackensack River RRF Navigable Gate Geometry – Navigable Passage and Auxiliary Flow Gates

Element ¹ (Gate Structure with Lettered ID)	No. Gates	Sill Elevation in ft NAVD88 (and in ft MLLW in parentheses)	Gate Width (ft)	Flow Area ¹ (ft ²)	Span ² (ft)	Notes	Top of Structure (ft, NAVD88)	Gate Height (ft)	Top of Lift Gate in Raised Position ³ (ft, NAVD88)
A	3	-20	150	9,099	480	Auxiliary Flow (Lift Gate)	+10	30	+39
B	1	-23 (-20)	100	2,322	250	Navigable Passage	+10	33	N/A
C	2	-20	150	6,066	320	Auxiliary Flow (Lift Gate)	+10	30	+39
D	1	-10	150	1,533	160	Auxiliary Flow (Lift Gate)	+10	20	+29
North Dam	0	N/A	N/A	0	230	Dam Section - North Bank	+10	N/A	N/A
South Dam	0	N/A	N/A	0	300	Dam Section - South Bank	+10	N/A	N/A
Total	7			19,020	1,740				

Notes

1 Flow area measured from elevation MSL to sill.

2 The span for navigable structures equals gate width + pier widths. Pier widths equal 65% of gate width, and the span for auxiliary structures equals gate width plus pier widths (pier widths equal 10 ft).

7.3 Newtown Creek RRF

This section summarizes the key hydraulic and geometric parameters for the conceptual design of the Newtown Creek navigable barrier risk reduction feature. For a design water level of +7 feet NAVD88 the crest elevation has been set at +10 feet NAVD88 (see also Section 2.7.11). A preliminary geometry for the RRF navigable gate opening has been established and is shown in Figure 7-2. The design is assumed to be similar to the design of the storm surge barrier as presented in Section 6.10 but with a crest elevation at +10 feet NAVD88. This geometry has been established based on the basis of design criteria as provided in Section 2 and includes one navigable opening to accommodate navigation (see Annex A for establishing the minimum dimensions of the navigable opening). The gate type selection for the navigable passage is documented in Annex A. This preliminary geometry is under evaluation with the use of hydrodynamic and ecological modeling (USACE ERDC, 2022).

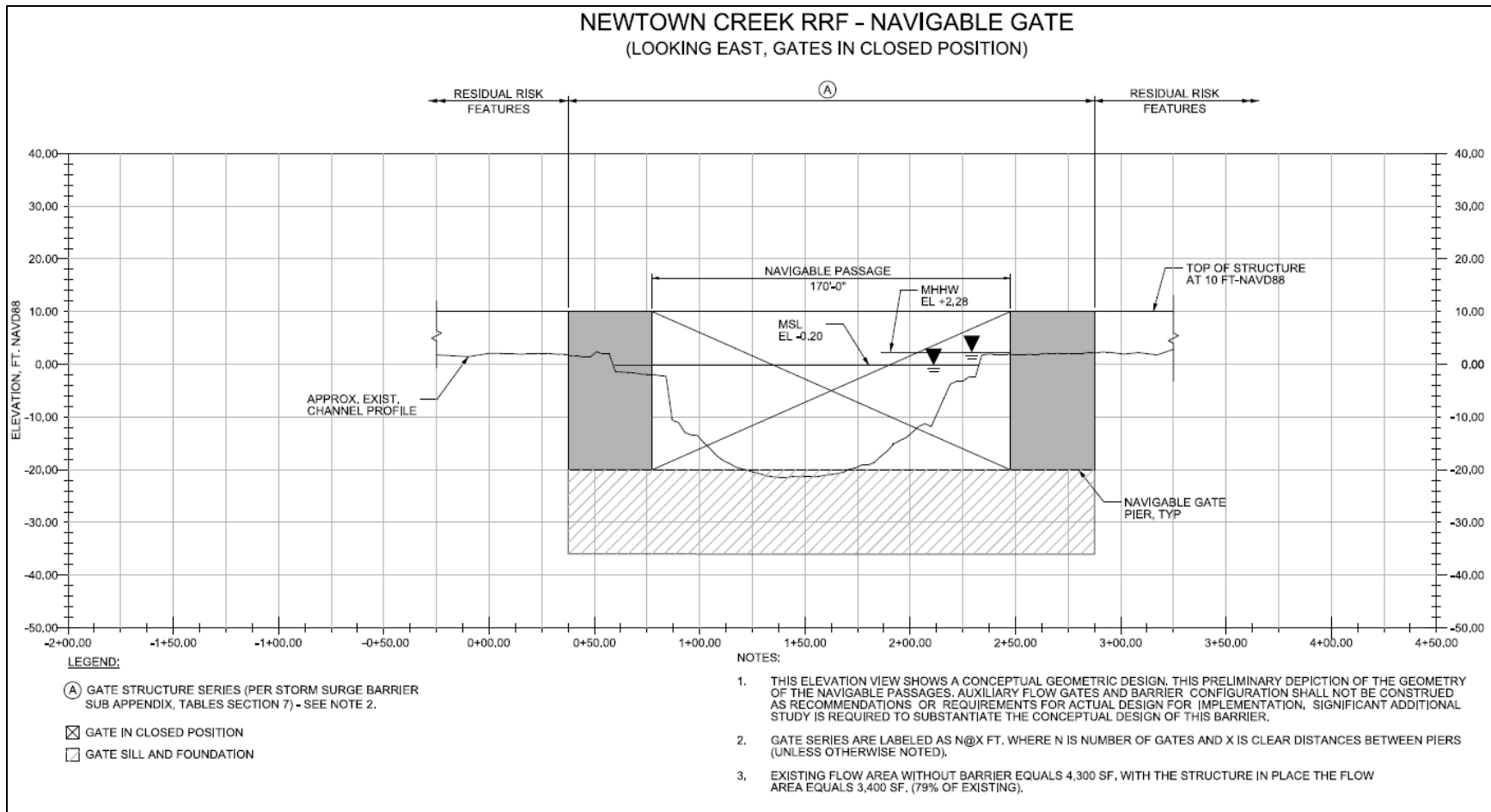

Figure 7-2: Conceptual Geometry of Gates of the Newtown Creek RRF Navigable Gate

Table 7-4: Summary of Newtown Creek RRF Navigable Gate Geometry – Navigable Passage

Element¹ (Gate Structure with Lettered ID)	No. Gates	Sill Elevation in ft NAVD88 (and in ft MLLW in parentheses)	Gate Width (ft)	Flow Area¹ (ft²)	Span² (ft)	Notes	Top of Structure (ft, NAVD88)	Gate Height (ft)
A	1	-20 (-18)	170	3,366	340	Navigable Passage (Sector Gate)	+10	30

Notes

1 Flow area measured from elevation MSL to sill.

2 The span for navigable structures equals gate width + pier widths. Pier widths equal 65% of gate width.

7.4 Gowanus Canal RRF

This section summarizes the key hydraulic and geometric parameters for the conceptual design of the Gowanus Canal navigable barrier risk reduction feature. For a design water level of +7 feet NAVD88 the crest elevation has been set at +10 feet NAVD88 (see also Section 2.7.11). A preliminary geometry for the RRF navigable gate opening has been established and is shown in Figure 7-3. The design is assumed to be similar to the design of the storm surge barrier as presented in Section 6.11 but with a crest elevation at +10 feet NAVD88. This geometry has been established based on the basis of design criteria as provided in Section 2 and includes one navigable openings to accommodate navigation (see Annex A for establishing the minimum dimensions of the navigable opening). The gate type selection for the navigable passage is documented in Annex A. This preliminary geometry is under evaluation with the use of hydrodynamic and ecological modeling (USACE ERDC, 2022).

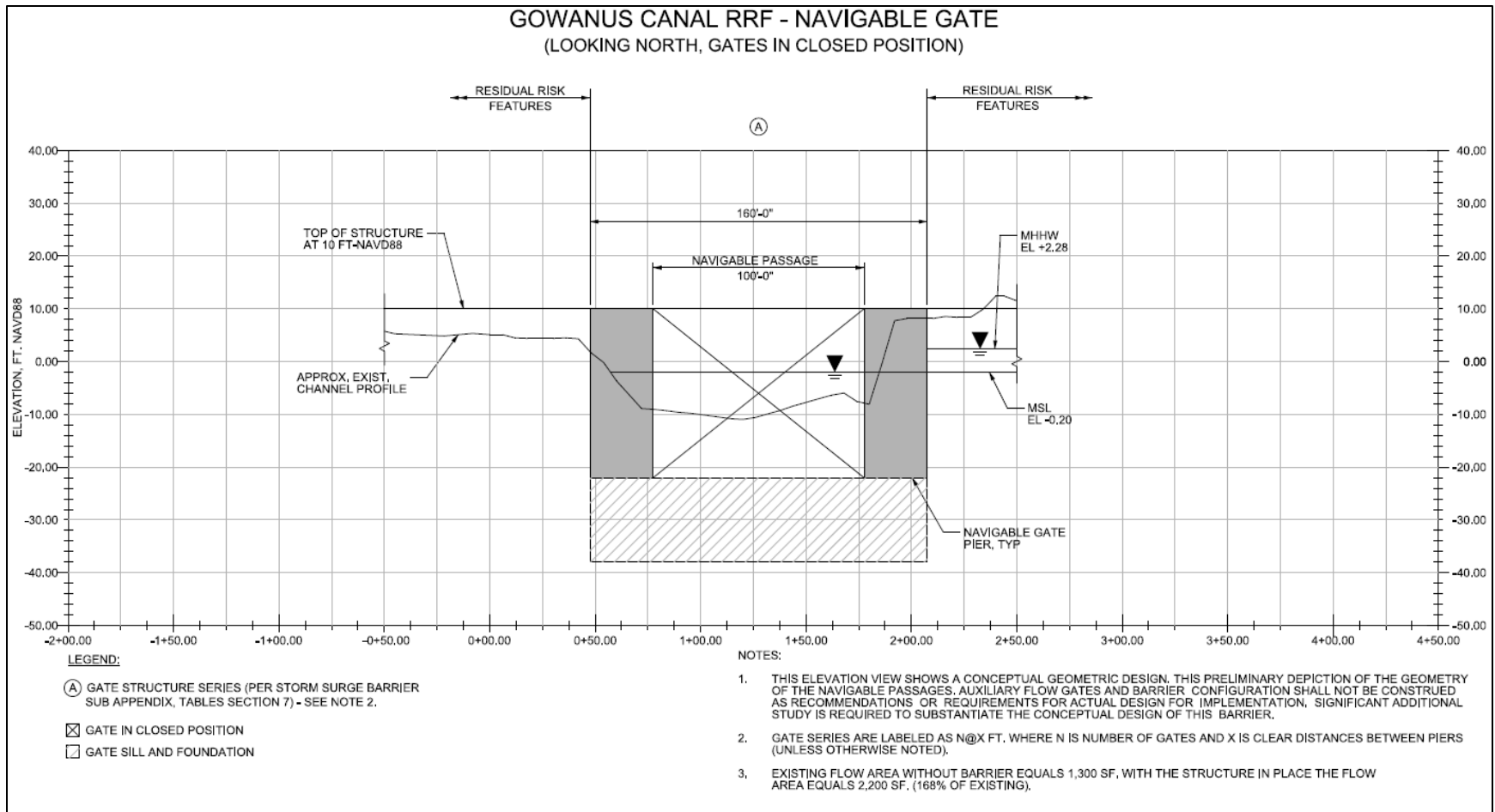

Figure 7-3: Conceptual Geometry of Gates of the Gowanus Canal RRF Navigable Gate

Table 7-5: Summary of Gowanus Canal RRF Navigable Gate Geometry – Navigable Passage

Element (Gate Structure with Lettered ID)	No. Gates	Sill Elevation in ft NAVD88 (and in ft MLLW in parentheses)	Gate Width (ft)	Flow Area¹ (ft²)	Span² (ft)	Notes	Top of Structure (ft, NAVD88)	Gate Height (ft)
A	1	-22 (-20)	100	2,180	160	Navigable Passage (Miter Gate)	+10	32

Notes:

1 Flow area measured from elevation MSL to sill.

2 Total span for gate structures equals gate width plus pier widths (30 ft each).

7.5 Sandy Hook Bridge RRF

This section summarizes the key hydraulic and geometric parameters for the conceptual design of the Sandy Hook Bridge navigable barrier risk reduction feature (Figure 7-4). For a design water level of +7 feet NAVD88 the crest elevation has been set at +10 feet NAVD88 (see also Section 2.7.11). A preliminary geometry for the RRF navigable gate openings has been established and is shown in Figure 7-5. This geometry has been established based on the basis of design criteria as provided in Section 2 and includes one navigable opening to accommodate navigation and a maximum number of auxiliary flow gates to maintain tidal exchange to the fullest extent possible. A conventional sector gate was selected for the navigable passage and a lift gate for the auxiliary flow opening for consistency with other smaller navigable barriers under the NYNJHAT Study. The existing cross-sectional flow area at the proposed RRF navigable gate location is approximately 14,300 ft². The aggregated flow opening area below MSL provided by the conceptual design is 12,400 ft² (approximately 87% of the existing flow area at that location). This preliminary geometry is under evaluation with the use of hydrodynamic and ecological modeling (USACE ERDC, 2022).

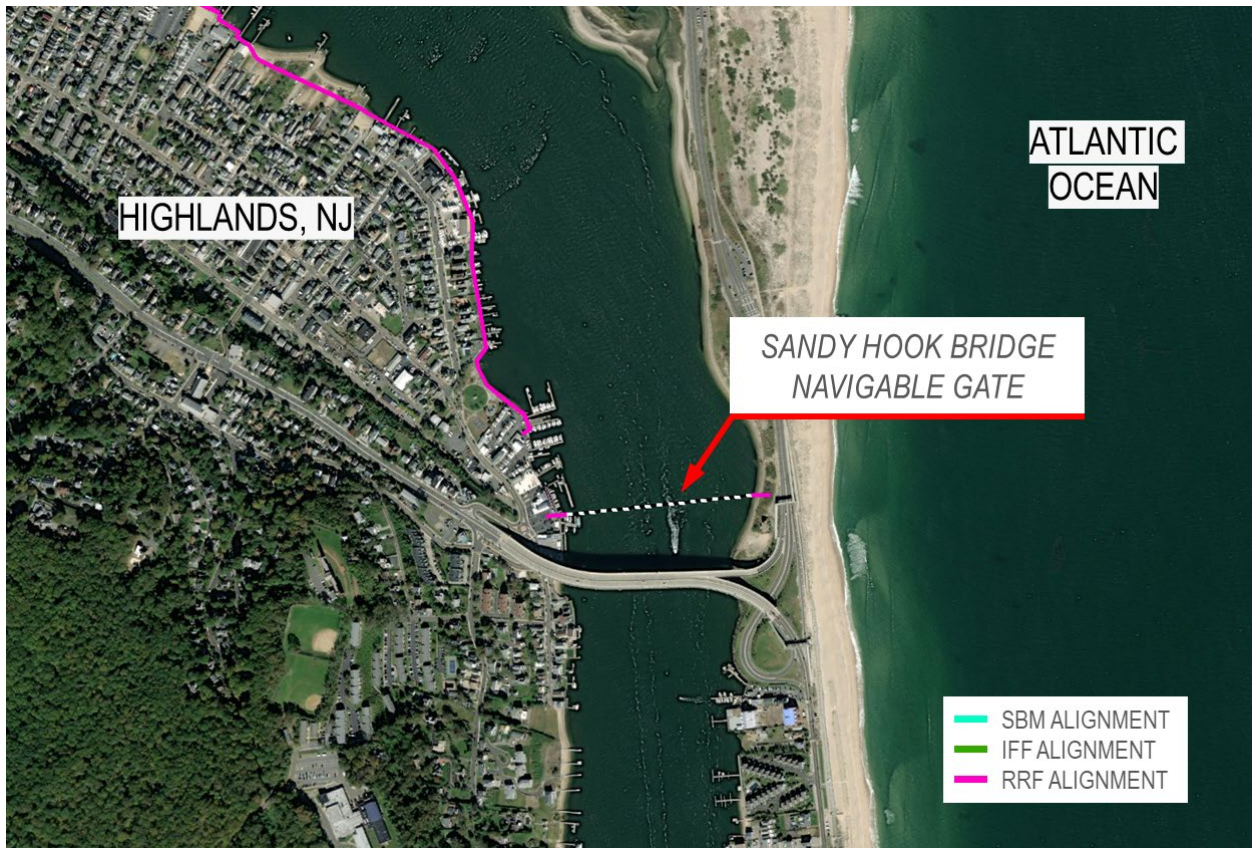

Figure 7-4: Sandy Hook Bridge Navigable Gate RRF, Approximate Location

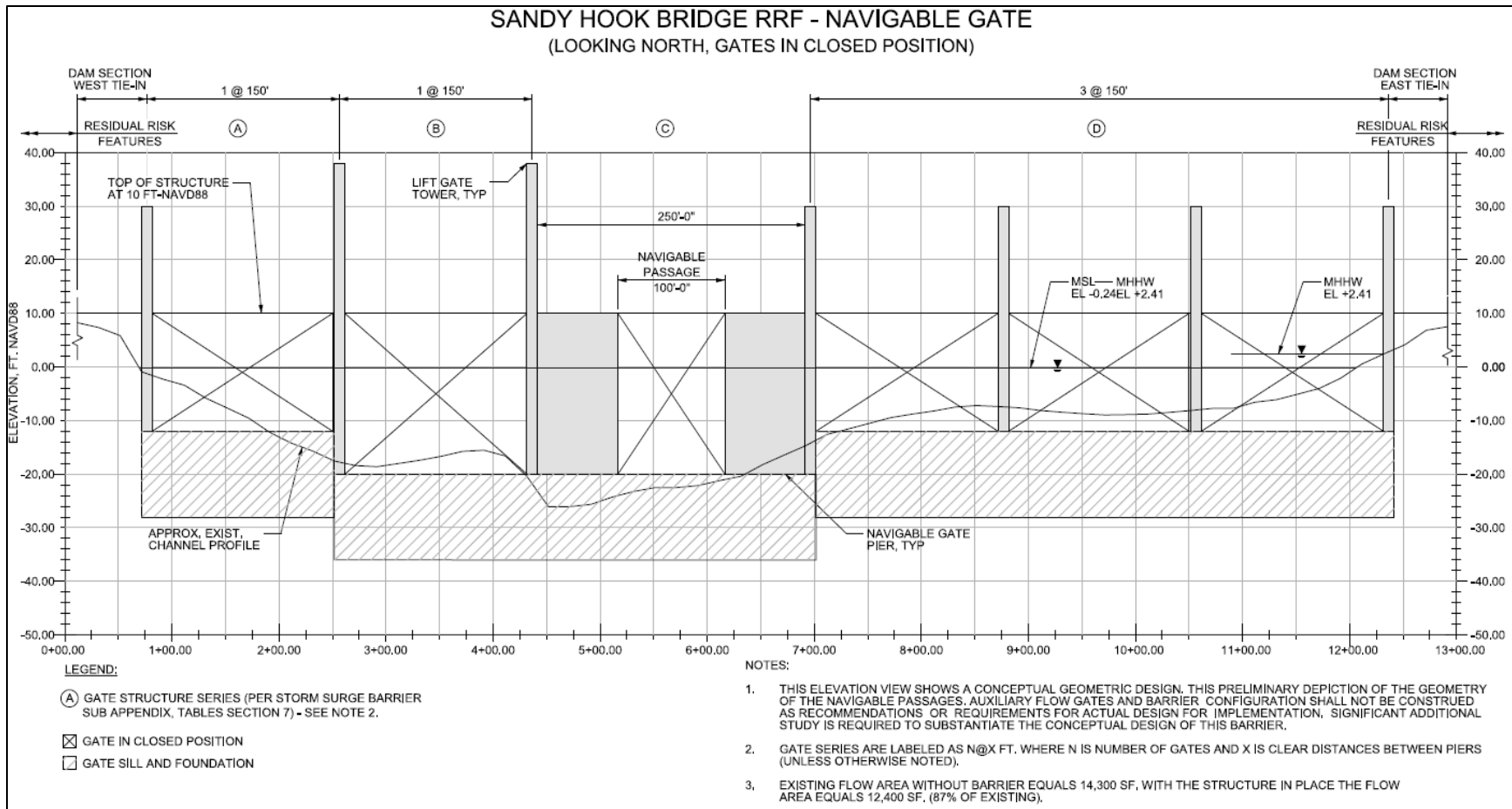

Figure 7-5: Conceptual Geometry of Gates of the Sandy Hook Bridge RRF Navigable Gate

Table 7-6: Summary of Sandy Hook Bridge RRF Navigable Gate Geometry – Navigable Passage and Auxiliary Flow Gates

Element ¹ (Gate Structure with Lettered ID)	No. Gates	Sill Elevation in ft NAVD88 (and in ft MLLW in parentheses)	Gate Width (ft)	Flow Area ¹ (ft ²)	Span ² (ft)	Notes	Top of Structure (ft, NAVD88)	Gate Height (ft)	Top of Lift Gate in Raised Position ³ (ft, NAVD88)
A	1	-12	150	1,833	160	Auxiliary Flow Gate (Lift Gate)	+10	22	+30
B	1	-20	150	3,033	160	Auxiliary Flow Gate (Lift Gate)	+10	30	+38
C	1	-20 (-18)	100	2,022	250	Navigable Passage (Sector Gate)	+10	30	N/A
D	3	-12	150	5,499	480	Auxiliary Flow Gate (Lift Gate)	+10	22	+30
North Dam	0	N/A	N/A	0	150	Dam Section North Bank	+10	N/A	N/A
South Dam	0	N/A	N/A	0	250	Dam Section South Bank	+10	N/A	N/A
Total	6			12,387	1,450				

Notes:

1 Flow area measured from elevation MSL to sill.

2 The span for navigable structures equals gate width + pier widths. Pier widths equal 65% of gate width, and the span for auxiliary structures equals gate width plus pier widths (pier widths equal 30 ft).

7.6 Head of Bay Gate RRF

This section summarizes the key hydraulic and geometric parameters for the conceptual design of the Head of Bay Gate navigable barrier risk reduction feature. For a design water level of +7 feet NAVD88 the crest elevation has been set at +10 feet NAVD88 (see also Section 2.7.11). A preliminary geometry for the RRF navigable gate openings has been established and is shown in Figure 7-7. This geometry has been established based on the basis of design criteria as provided in Section 2 and includes one navigable opening to accommodate navigation and a maximum number of auxiliary flow gates to maintain tidal exchange to the fullest extent possible. A conventional sector gate was selected for the navigable passage and a lift gate for the auxiliary flow opening for consistency with other smaller navigable barriers under the NYNJHAT Study. The existing cross-sectional flow area at the proposed RRF navigable gate location is approximately 2,000 ft². The aggregated flow opening area below MSL provided by the conceptual design is 4,300 ft² (approximately 215% of the existing flow area at that location). This preliminary geometry is under evaluation with the use of hydrodynamic and ecological modeling (USACE ERDC, 2022).



Figure 7-6: Head of Bay Navigable Gate RRF, Approximate Location

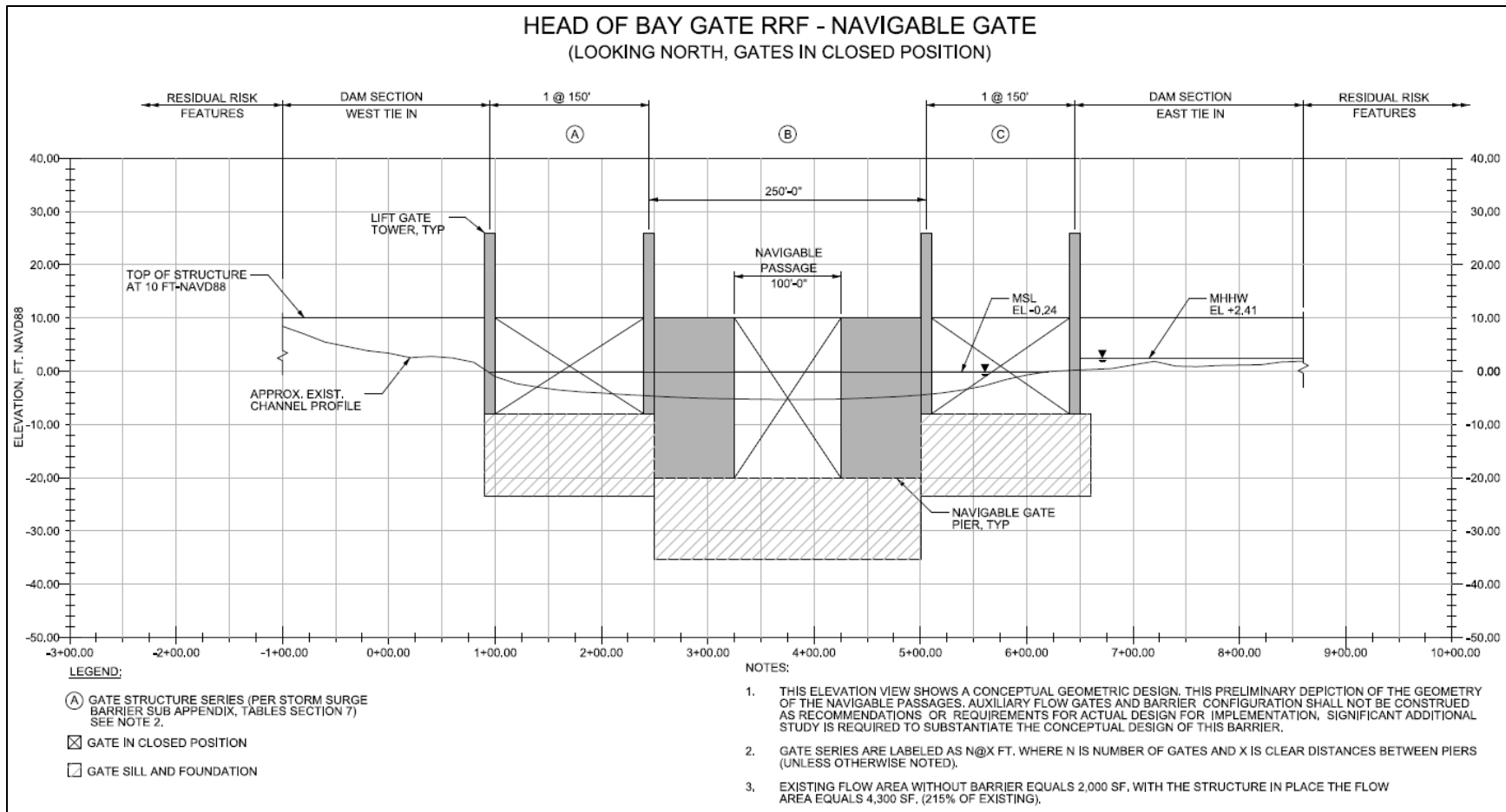

Figure 7-7: Conceptual Geometry of Gates of the Head of Bay Gate RRF Navigable Gate

Table 7-7: Summary of Head of Bay Navigable RRF Gate Geometry – Navigable Passage and Auxiliary Flow Gates

Element ¹ (Gate Structure with Lettered ID)	No. Gates	Sill Elevation in ft NAVD88 (and in ft MLLW in parentheses)	Gate Width (ft)	Flow Area ¹ (ft ²)	Span ² (ft)	Notes	Top of Structure (ft, NAVD88)	Gate Height (ft)	Top of Lift Gate in Raised Position ³ (ft, NAVD88)
A	1	-8	150	1,164	160	Auxiliary Flow Gate (Lift Gate)	+10	18	+26
B	1	-20 (-18)	100	1,976	250	Navigable Passage (Sector Gate)	+10	20	N/A
C	1	-8	150	1,164	160	Auxiliary Flow Gate (Lift Gate)	+10	18	+26
North Dam	0	N/A	N/A	0	300	Dam Section North Bank	+10	N/A	N/A
South Dam	0	N/A	N/A	0	200	Dam Section South Bank	+10	N/A	N/A
Total	3			4,304	1,070				

Notes:

1 Flow area measured from elevation MSL to sill.

2 The span for navigable structures equals gate width + pier widths. Pier widths equal 10 feet for auxiliary structures equals gate width plus pier widths (pier widths equal 30 ft).

3 Top of single leaf lift gate with headwall at +8 ft.

7.7 Old Howard Beach East Gate RRF

This section summarizes the key hydraulic and geometric parameters for the conceptual design of the Old Howard Beach East Gate navigable barrier risk reduction feature. For a design water level of +7 feet NAVD88 the crest elevation has been set at +10 feet NAVD88 (see also Section 2.7.11). A preliminary geometry for the RRF navigable gate openings has been established and is shown in Figure 7-9. This geometry has been established based on the basis of design criteria as provided in Section 2 and includes one navigable opening to accommodate navigation and to maintain tidal exchange to the fullest extent possible. A conventional sector gate was selected for the navigable passage for consistency with other smaller navigable barriers under the NYNJHAT Study. The existing cross-sectional flow area at the proposed RRF navigable gate location is approximately 4,800 ft². The aggregated flow opening area below MSL provided by the conceptual design is 900 ft² (approximately 19% of the existing flow area at that location). This preliminary geometry is under evaluation with the use of hydrodynamic and ecological modeling (USACE ERDC, 2022).



Figure 7-8: Howard Beach East (and West) Navigable Gate RRF, Approximate Location

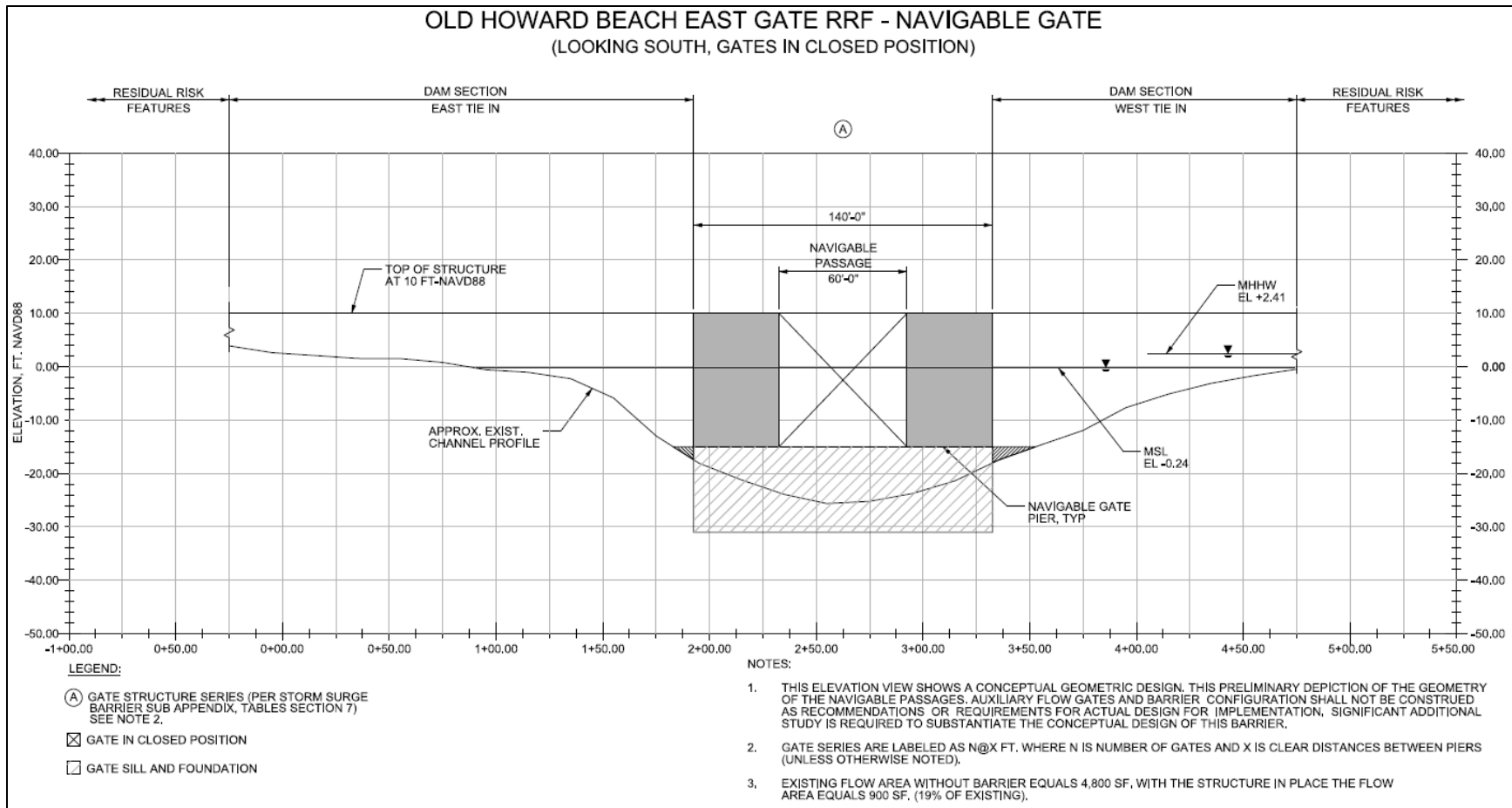

Figure 7-9: Conceptual Geometry of Gates of the Old Howard Beach East Gate RRF Navigable Gate

Table 7-8: Summary of Old Howard Beach East Gate RRF Navigable Gate Geometry – Navigable Passage

Element ¹ (Gate Structure with Lettered ID)	No. Gates	Sill Elevation in ft NAVD88 (and in ft MLLW in parentheses)	Gate Width (ft)	Flow Area ¹ (ft ²)	Span ² (ft)	Notes	Top of Structure (ft, NAVD88)	Gate Height (ft)	Top of Lift Gate in Raised Position ³ (ft, NAVD88)
A	1	-15 (-13)	60	890	140	Navigable Passage (Sector Gate)	+10	25	N/A
East Dam	0	N/A	N/A	0	200	Dam Section East Bank	+10	N/A	N/A
West Dam	0	N/A	N/A	0	250	Dam Section West Bank	+10	N/A	N/A
Total	1			890	590				

Notes

1 Flow area measured from elevation MSL to sill.

2 The span for navigable structures equals gate width + pier widths. Pier widths equal 65% of gate width, and the span for auxiliary structures equals gate width plus pier widths (pier widths equal 30 ft).

3 Top of single leaf lift gate with headwall at +8 ft.

7.8 Old Howard Beach West Gate RRF

This section summarizes the key hydraulic and geometric parameters for the conceptual design of the Old Howard Beach West Gate navigable barrier risk reduction feature (Figure 7-8). For a design water level of +7 feet NAVD88 the crest elevation has been set at +10 feet NAVD88 (see also Section 2.7.11). A preliminary geometry for the RRF navigable gate openings has been established and is shown in Figure 7-10. This geometry has been established based on the basis of design criteria as provided in Section 2 and includes one navigable opening to accommodate navigation and maintain tidal exchange to the fullest extent possible. A conventional sector gate was selected for the navigable passage for consistency with other smaller navigable barriers under the NYNJHAT Study. The existing cross-sectional flow area at the proposed RRF navigable gate location is approximately 1,100 ft². The aggregated flow opening area below MSL provided by the conceptual design is 900 ft² (approximately 82% of the existing flow area at that location). This preliminary geometry is under evaluation with the use of hydrodynamic and ecological modeling (USACE ERDC, 2022).

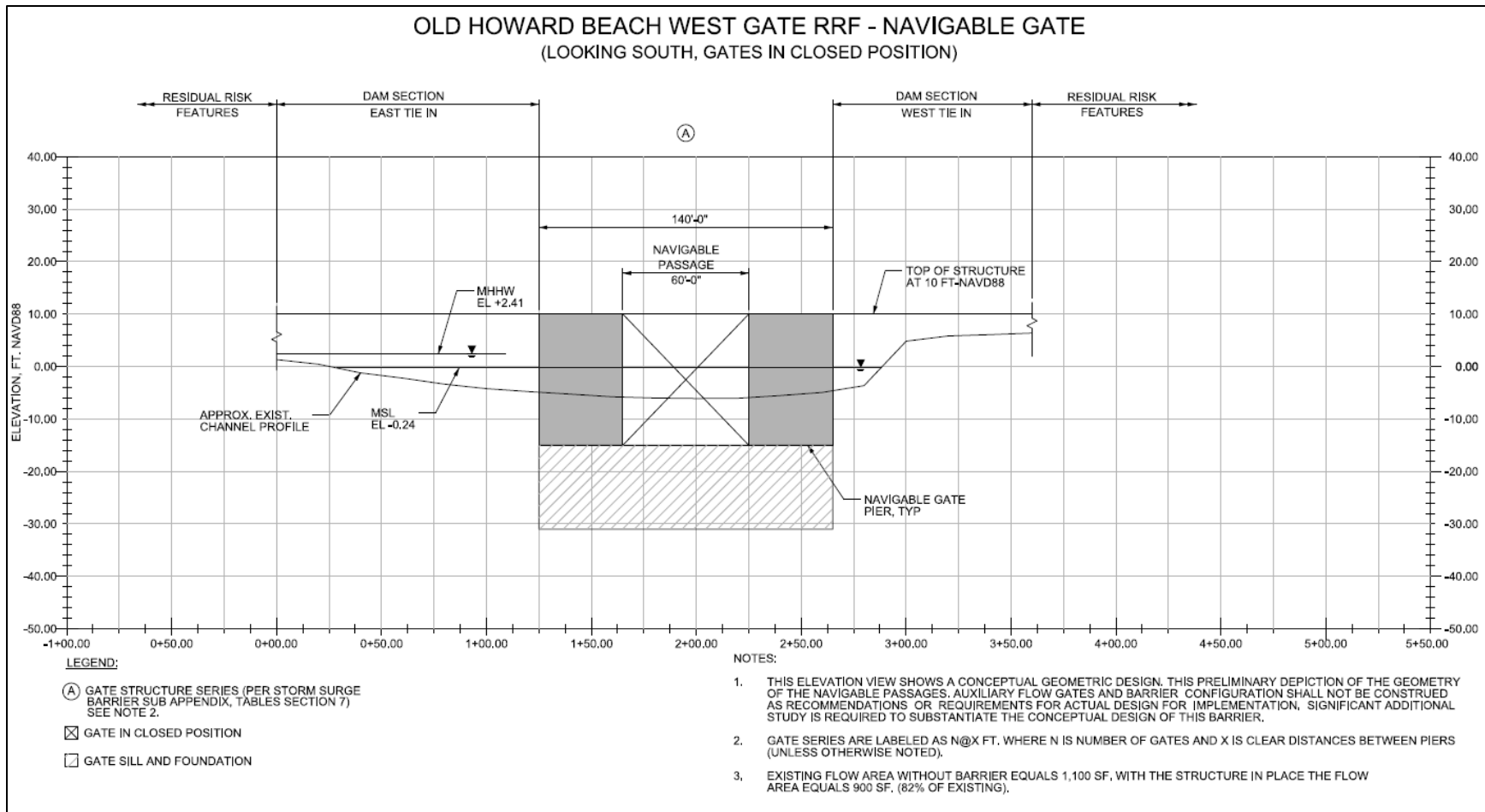

Figure 7-10: Conceptual Geometry of Gates of the Old Howard Beach West Gate RRF Navigable Gate

Table 7-9: Summary of Old Howard Beach West Gate RRF Navigable Gate Geometry – Navigable Passage

Element¹ (Gate Structure with Lettered ID)	No. Gates	Sill Elevation in ft NAVD88 (and in ft MLLW in parentheses)	Gate Width (ft)	Flow Area¹ (ft²)	Span² (ft)	Notes	Top of Structure (ft, NAVD88)	Gate Height (ft)	Top of Lift Gate in Raised Position³ (ft, NAVD88)
A	1	-15 (-13)	60	890	140	Navigable Passage (Sector Gate)	+10	25	N/A
East Dam	0	N/A	N/A	0	150	Dam Section East Bank	+10	N/A	N/A
West Dam	0	N/A	N/A	0	200	Dam Section West Bank	+10	N/A	N/A
Total	1			890	490				

Notes

1 Flow area measured from elevation MSL to sill.

2 The span for navigable structures equals gate width + pier widths. Pier widths equal 65% of gate width, and the span for auxiliary structures equals gate width plus pier widths (pier widths equal 30 ft).

3 Top of single leaf lift gate with headwall at +8 ft.

8 Recommendations for Further Study

8.1 Introduction

This study is the first where a suite of storm surge barriers is evaluated for the New York and New Jersey Harbor. The conceptual designs for the storm surge barriers, as part of the NYNJHAT Study Alternatives, are based upon a broad yet comprehensive data analysis for the entire study area. Initial evaluations developed to a greater with equal level of detail involve the Verrazzano Narrows, Jamaica Bay, and Hackensack River Barrier locations, for each storm surge barrier. The basis of design, although preliminary, is consistently prepared for all storm surge barrier locations and include, amongst other items, the latest hydrodynamic storm surge modeling results to establish boundary conditions for design, AIS traffic data analyses, and a basis for the minimum required dimensions of the navigable passages. Most importantly, the conceptual designs and geometries of the storm surge barriers are evaluated using hydrodynamic models and are not solely analyzed on an individual basis but analyzed using a systems approach (USACE ERDC, 2019). This document is the first step in an iterative design process using a systems approach, whilst previous completed studies in large part only provided singular concepts and did not assess impacts to the regional hydrodynamics, nor did those studies use such assessments to further the conceptual designs.

Furthermore, the gate types are selected based on a general evaluation and the applicability of such gates based on the review of constructed storm surge barriers. The conceptual design as presented herein is in part informed by the data and by characteristics of other storm surge barriers that have been constructed throughout the world. The conceptual design is built upon proven concepts and principles, which in turn improve the reliability of the overall concepts. In some instances, the concepts considered are larger in scope and scale than those that currently exist in practice. Nonetheless, although some elements are proportionally larger, there is confidence that the concepts presented are both constructible and feasible in their implementation.

Despite the depth and breadth of preliminary evaluation, this assessment of navigable passage widths and storm surge barrier configurations shall not be construed as definitive recommendations or requirements for actual design for implementation. Significant additional study is required to substantiate the width, location, and configuration of the navigable passages and auxiliary flow gates, including a full evaluation of navigation, environmental, ecological, and cost considerations, amongst others.

The next sections provide a framework of additional studies and engineering analyses that should be considered, and what those efforts should at a minimum entail⁸. Certain topics can be expanded upon if there is a need to prioritize or expedite the refinement of a selected set of storm surge barrier designs.

⁸ These sections are geared towards engineering analyses and studies, while it is recognized that environmental, economic, socioeconomic and other studies would be required similarly.

8.1.1 Iterative Design – Next Steps

Following the analyses described within this report, there are several overarching topics that warrant further investigation and are considered logical next steps as part of an iterative design process. For completeness, these topics are summarized here. One of the main tasks to be evaluated for each storm surge barriers is an advanced siting study. A complete siting study for the storm surge barriers would evaluate pros and cons of various alignment and conceptual design alternatives for each storm surge barrier. Such analyses should consider the following topics:

- Navigable passage dimensions:
 - The required width of the navigable passage
 - Requirements for one-way versus two-way traffic for the navigable passage (further detailed below under Navigation – Section 8.1.5, below)
- The impact of current velocities on navigation and the required dimensions of openings within the storm surge barrier to minimize impacts to navigation conditions. In particular,
 - For the Outer Harbor, storm surge barrier preliminary modeling results indicate that under the configuration of NYNJHAT Study Alternative 2, flow velocities through the navigable passages of the Sandy Hook Channel and Ambrose Channel could exceed 3 knots during normal hydrometeorological conditions more than 26% and 18% of the time, respectively (USACE ERDC, 2019).
 - For the Verrazzano Narrows, storm surge barrier preliminary modeling results indicate that under the configuration of NYNJHAT Study Alternative 3A flow velocities through the navigable passage could exceed 3 knots more than 16% of the time during normal hydrometeorological conditions (USACE ERDC, 2019). The design dimensions proposed herein exceed the modeled dimensions, and it is recommended to reassess the change in impacts on flow velocities and tidal amplitude through numerical modeling for this particular storm surge barrier.
 - For Jamaica Bay, storm surge barrier similar conditions were observed for NYNJHAT Study Alternatives 3A, 3B, and 4, yet exceedance of 3 knot current velocity was around 10% of the time for all alternatives (USACE ERDC, 2019).
 - Alternate storm surge barrier alignments with a longer span and relatively lower percentage of flow impediment may alleviate such concerns.
- Existing channel conditions and proposed sill elevation – For several storm surge barrier locations, the reported channel conditions are less than the authorized channel dimension due to shoaling. The sill elevation of the navigable passage has been determined based on authorized channel depth, yet at certain locations, this may require substantial channel maintenance (i.e., dredging) prior to construction of the storm surge barrier. A couple of examples are provided below:
 - East Chester Creek and Bronx River
 - Shoaling up and downstream of proposed storm surge barrier location
 - Westchester Creek
 - Up to 10 feet of shoaling for the majority of the channel reach

- Flushing Creek
- Shoaling in outside quarters of the channel at the proposed storm surge barrier location
- Newtown Creek
- The recommendations from the 2016 report (CH2MHill, 2016b) to set the sill elevation at -20 feet NAVD88 is utilized here to establish the conceptual design with the understanding that those recommendation are the result of a site-specific feasibility study at a higher level of detail than the feasibility analysis of storm surge barriers at a regional scale discussed herein. It should be emphasized, however, that the channel is authorized at -23 feet MLLW (-26 NAVD88), and as such, a limitation to the authorized channel depth needs to be accepted at a later date.
- Alternative gate types for the navigable passage:
 - It should be noted that this is a high-level evaluation as no site-specific geotechnical borings are available and designs for the gates are still conceptual in nature. Further recommendations regarding geotechnical evaluations are provided below.
 - For the Outer Harbor and Verrazzano Narrows storm surge barrier, the floating sector gate span for the Ambrose Channel is beyond the limits of previously constructed comparable gates (>1,400 foot wide opening vs. 1,190 foot and 660 foot for Maeslant and St. Petersburg Storm Surge Barrier, respectively). The gate housing of the floating sector gates occupies a relative substantial portion of the cross-section of the existing waterway and reduces the existing flow area. Following the current velocity concerns raised above, alternate gate configurations which occupy a smaller percentage of the existing cross-section should be investigated further.
 - For the Throgs Neck storm surge barrier, the floating sector gate has been preliminarily selected for the navigable passage. The floating sector gate span (450 feet) is within the limits of previously constructed comparable gates, yet alternate gate configurations which occupy a smaller percentage of the existing cross-section should be investigated further to limit impacts on the tidal flow exchange. An example for this location could be flap gates or a barge gate:
 - The largest barge gate constructed as part of a storm surge barrier spans an opening of 150 feet (IHNC storm surge barrier). A barge gate with the proposed span for Throgs Neck has not yet been constructed but has been considered elsewhere (van Ledden, Lansen, de Ridder, & Edge, 2012)
 - Flap gates can be placed in series to provide a large navigable opening, but the reverse head conditions for this site and the complexity of such structures may make it a less favorable candidate.
 - For those locations where air clearances are restricted, or the option exists to make air clearances restricted, lift gates may be suitable alternates.

- Apart from the examples provided here, it is recommended to analyze, cost, and compare alternate gate types for all selected storm surge barriers. Potential alternate gate types for each barrier location are indicated in Annex A.
- Alternative Gate types for the auxiliary flow gates:
 - For the majority of the storm surge barriers, the lift gate was selected for the auxiliary flow structures. At those locations where reverse head conditions are of limited concern, a tainter gate is most likely a viable option too. For example, USACE’s 1970s study for Jamaica Bay (USACE-WES, 1976) considered tainter gates. Applicability of tainter gates will, in large part, depend on reverse head conditions and the potential for relatively high load concentration on the trunnion bearings. In addition, for locations that are shallower with a fairly even bathymetric profile, rotating segment gates or inflatable gates could be considered.
 - For the Verrazzano Narrows, lift gates were preliminarily selected, and the sill elevation was set at -60 feet NAVD88, which exceeds sill elevations of constructed lift gate structures in storm surge barriers. Additional flow area to alleviate current magnitude concerns may be realized if the sill elevation is lowered even further. It would come at additional cost, and a gate type study is recommended to quantitatively assess and compare different gate types.
 - The conceptual designs presented maximized the number of auxiliary flow gates to the extent practicable to minimize impacts on flow exchange. For two storm surge barriers, the number of proposed lift gates exceeds those from prior studies (e.g., for the Jamaica Bay and Hackensack River storm surge barrier). At some locations, a different configuration (less openings or slightly less total flow area) may result in no appreciable difference in tidal flow exchange, but could potentially be more economical.
 - Apart from the examples provided here, it is recommended to analyze, cost, and compare alternate auxiliary flow gate types for all selected storm surge barriers. Potential alternate gate types for each barrier location are indicated in Annex A.
- Geotechnical site conditions:
 - Foundation concepts were based on a high-level evaluation as no site-specific borings are available and the designs for the gates are still very conceptual. It is recommended that a geotechnical data gap analyses be completed, site specific geotechnical data gathered as needed to supplement available information, and a design geotechnical profile established for each storm surge barrier location. Site-specific ground investigations may be conducted in phases to balance need for progressively more detailed data at each project milestone against funding availability and risk that a given barrier location may not be implemented.
 - Following data collection, gate type selection should be revisited considering foundation constraints, estimated seepage gradients, constructability, etc.

8.1.2 Constructability

The siting and eventual construction of a storm surge barrier is a complex undertaking, and practical constraints may influence the eventual design based on constructability considerations. Constructability will influence design considerations, structure type, project costs, phasing requirements, and schedule. Large civil works projects involving marine-based construction are represented by significant complexity and cost factors. These factors are generally exacerbated as water depth, flow velocities, and proximity to navigation channels are considered. Likewise, structure configurations used to overcome the spatial and loading criteria for which the structure must perform also heavily influence complexity and cost. Hence, basic constructability assessments must be performed to consider viability and provide for proof of concept for foundations and structure types under consideration.

Constructability evaluations are an inherent part of any major civil works undertaking. Among the many considerations when considering constructability, the following should be considered:

- Maintenance of navigation and navigational impacts during construction
- General method of construction (e.g., in-the-dry, in-the-wet)
- Temporary works (e.g., cofferdams)
- Site access (e.g., barge-based work versus land-based access via temporary trestle)
- Site staging and laydown areas
- Material deliveries to the work site (e.g., floating concrete plant)
- Contractor capabilities, and the availability of both specialized contractors and equipment needed to perform the work
- Feasibility, availability, and locations of off-site fabrication areas for modular elements (e.g., graving dock for float-in elements)
- Variability of subsurface conditions, and methods used to provide adequate foundations
- Impact from tides, current, weather, and other environmental factors on construction activities
- Extreme event scenarios, preparedness provisions, and similar risk considerations
- Potential availability of construction materials, including quality and quantity
- Waste and recycled materials considerations, including beneficial use
- Environmental considerations affecting construction activities (e.g., relocations, noise, work period restrictions)
- Construction schedule, including a variety of phasing and funding scenarios

8.1.3 Hydraulics, Hydrology, and the Aquatic Environment

The complexity of the regional hydraulics and hydrology warrants further study in the following topics:

- Permissible overtopping quantities and permissible leakage through the storm surge barrier to optimize structure elevation.

- Currently, an overtopping criterion of 200 l/s/m is applied, which could still be considered a conservative criterion as some coastal structures can accommodate higher overtopping discharges if properly designed for (USACE, 2002).
- Besides the proposed conventional option, one alternate option that is recommended to be considered is a gated weir structure that allows for both flow through it during normal hydraulic and meteorological conditions while allowing for flow over the crest during severe storm surge conditions. The purpose of the storm surge barrier is to impede storm surge, which does not equate to complete blockage of the flow.
- Analyses of impacts to the tidal flow exchange and impacts to the tidal amplitude as a result of the proposed geometry. Such analyses should further the work completed by ERDC (USACE ERDC, 2019) and continue the iterative design process to refine the storm surge barrier geometry, and include:
 - Assessment of the impact on water surface elevations, discharges, and average velocities in the openings, and
 - Assessment of local hydraulic changes in the inner basin, harbor, or bay, such as local velocities and currents, salinities, tidal levels and circulation which are essential to pollution, fish and wildlife, and other environmental and ecological considerations.
- Analyses of potential changes in tidal flow exchange and the impacts on both local and far-field morphology:
 - The net longshore sediment transport at both Sandy Hook and Rockaway Inlet are directed towards the New York Bight. Future analysis will need to evaluate the potential for erosion and sedimentation in the region of the storm surge barrier.
- Sea level rise sensitivity and adaptability analyses:
 - Perform tests with different SLC scenarios and investigate changes in hydrostatic and dynamic loading as well as changes in overtopping discharge, and identify options and project features that can provide for an adaptable design; and
 - Adaptive management may be necessary or structural improvements may be needed if the observed sea level rise exceeds the planning criteria. Such provisions would be included in the design to accommodate improvements if and when needed.
- Impacts to water levels on the protected side during gate closures (reverse head conditions):
 - Analysis of inflows and potential for a rise in water levels on the protected side of the storm surge barrier after gate closure. This holds for all storm surge barriers discussed herein, but of particular note is the conceptual design for the Hackensack River storm surge barrier (USACE, February 1989) and Newtown Creek (CH2MHill, 2016b), which included a pump stations in line with the gated barrier.
 - Analysis of joint probability of river discharge (flood levels) and storm surge levels. This is, in particular, of interest for the Hackensack River storm surge barrier.

- Impacts to water levels to adjacent areas on the flood side of the storm surge barriers.
- Analysis of impacts to water quality during and after gate closure.
- Analyses of potential changes in tidal flow exchange and impacts on salinity, water quality, and ecology.

8.1.4 Navigation

The New York Bight, between Sandy Hook and the Rockaway Peninsula, is the principal entrance to the New York and New Jersey Harbor, and is one of the busiest waterways in the USA. Constructing a storm surge barrier across a navigation channel will require further study in the following areas.

- Waterway traffic:
 - One-way versus two-way vessel passage, including meeting, passing, and overtaking
 - Number, frequency, and intensity of vessel passage
 - Vessel anchorage areas, queuing, and wait times
 - Storm surge barrier positioning and fairway lengths for maneuvering
 - Trends for future vessel traffic, including vessel size and frequency
 - Passage of recreational vessels
- Currents, cross currents, wind, tides, surge, weather, night, visibility, and other environmental considerations for vessel passage
- Navigation evaluations, including pilot and navigation industry input, and real-time simulations to assess, amongst others:
 - Flow and cross-current considerations
 - Gate approach and departure
 - Passing vessel assessments
- Risk evaluations, including probability of aberrancy, assessment of collision loads, evaluation of gated structures capacity to withstand impact, damage scenario assessments, and steps to be taken to mitigate risk of collision damage or collapse
- Requirements for aids-to-navigation, guide structures, and protective structures
- Requirements for vessel traffic service, including advisory / control / restrictions on navigation
- National security considerations

8.1.5 Operations and Maintenance

Considerations for operations and maintenance affect the overall design philosophy. Operation and maintenance costs are a substantial part of the life cycle cost of storm surge barriers. Important factors that determine operation and maintenance costs are: 1) maintenance of the movable parts of the structure; 2) painting (steel) parts of the structure; 3) operations and maintenance personnel costs; 4) cost of an operational data and decision support network; 5) inspection of parts including submerged parts (after van Ledden, et al. 2012); and 6) control systems, remote operation,

emergency operation, redundant systems; and 7) size, scope, equipment, and location of facilities to support Operations and Maintenance. The following topics will require further study.

- Operational criteria for gate closure and the expected frequency of gate closures.
- Timescales for deployment, reliability, and operation of gate and warning systems.
- Reliable operation of the storm surge barrier (gate closures) to obtain a reduction in flood risk.
- Reliable operation of the storm surge barrier gates to minimize the impacts of gate closures on navigation and the aquatic environment.
- Reduce, to the extent practicable, the complexity of Operation and Maintenance, Repair, Replacement and Rehabilitation (OMRR&R).

8.1.6 Multi-functionality of a Storm Surge Barrier Complex

Several of the storm surge barriers discussed herein are proposed in close vicinity to industrial and residential development areas. The tie-in to the shore-based perimeter flood risk reduction system and the integration of the form and function of the storm surge barrier would require further study. There may be opportunities to further blend form and function, and to assess shared uses and multi-functionality of this civil works complex such that it provides additional benefits to the community. Topics that require further study are:

- Inclusion of transportation infrastructure (roadways, bridges, and tunnels);
- Potential for connections to existing transportation infrastructure;
- Inclusion of recreational, educational areas, and other considerations for public access; and,
- An assessment of aesthetics.

This report is part of a series of reports that document the preliminary analysis completed in support of the feasibility of the New York–New Jersey Harbor and Tributaries Coastal Storm Risk Management Feasibility Study.

References

- AECOM. (2018). *Feasibility Study of Rebuild by Design Meadowlands Flood Protection Project*. Trenton: State of New Jersey Department of Environmental Protection. Retrieved from <https://www.nj.gov/dep/floodresilience/docs/rbdlm-fs/subappendix-f1-alt-1-development-and-screening.pdf>
- Aerts, J., Botzen, W., & De Moel, H. (2013). *Cost Estimates for Flood Resilience and Protection Strategie in New York City*. New York: Annals of the New York Academy of Sciences.
- Aerts, J., De Moel, H., & Botzen, W. (2013). Cost Estimates for Flood Resilience and Protection Strategie in New York City. *Annals of the New York Academy of Sciences*.
- Blumberg, A. F., Khan, L. A., & St John, J. P. (1999). Three-Dimensional Hydrodynamic Simulations of the New York Harbor, Long Island and the New York Bight. *Journal of Hydraulic Engineering*, 799-816.
- Bowman, M. J., Colle, B., Roger, F., Douglass, H., Wilson, R. E., Buonaiuto, F., . . . Zheng, Y. (2004). *Hydrologic Feasibility of Storm Surge Barriers to Protect the Metropolitan New York - New Jersey Region*. Stony Brook, NY: Marine Science Research Center.
- Bowman, M. J., Hill, D., Buonaiuto, F., Colle, B., Flood, R., Wilson, R., . . . Wang, J. (2008). Threats and Responses Associated with Rapid Climate Change in Metropolitan New York. In M. MacCracken, F. Moore, & J. C. Topping, *Sudden and Disruptive Climate CHange* (p. 327). Earthscan Publications Ltd.
- CH2MHill. (2016a). *Gowanus Canal Storm Surge Barrier Study, Final Report*. January 2016, New York, NY. Retrieved 9 01, 2018, from https://www.gowanuscanal.org/sites/default/files/Newtown_Final_Report_Combined.pdf
- CH2MHill. (2016b). *Newtown Creek Storm Surge Barrier Study, Final Report*. January 2016, New York, NY. Retrieved 9 1, 2018, from https://www1.nyc.gov/assets/orr/pdf/Gowanus_Canal_Final_Report_Combined.pdf
- Dijk, A. a. (2010). *Multifunctionele beweegbare waterkeringen [Multifunctional movable flood gates]*. Delft, The Netherlands. Retrieved from http://www.tudelft.nl/fileadmin/UD/MenC/Support/Internet/TU_Website/TU_Delft_porta l/Onderzoek/Infrastructure/Engineering_challenges/open_en_afsluitbaar_Rijnmond/doc/AOR_Multifunctionele_beweegbare_keringen_FvdZiel_ADijk,_TUD,RCP,KvK_Definitief.pdf
- Dircke, P., Jongeling, T., & Jansen, P. (2012). Navigable storm surge barriers for coastal cities: An overview and comparison. In J. Aerts, W. Botzen, M. Bowman, P. Ward, & P. Dircke, *Climate Adaptation and Flood Risk in Coastal Cities* (pp. 201-223). New York: Earthscan.
- Hill, D. (Ed.). (2013). *Against the Deluge: Storm Surge Barrier to Protect New York City*. (p. 257). New York, NY: American Society of Civil Engineers.

- HydroQual. (2007). *A Model for the Evaluation and Management of Contaminants of Concern in Water Sediment, and Biota in the NY/NJ Harbor Estuary*. New York, NY: Hudson River Foundation.
- Mooyaart, L. F., & Jonkman, S. N. (2017). Overview and Design Considerations of Storm Surge Barriers. *ASCE Journal of Waterway, Port, Coastal and Ocean Engineering*, 143(4).
- Mooyaart, L. F., Jonkman, S. N., de Vries, P. A., van der Toorn, A., & van Ledden, M. (2014). Storm Surge Barrier: Overview And Design Considerations. In P. J. Lynett (Ed.), *Coastal Engineering Proceedings* (p. 808). Seoul, Korea: Coastal Engineering Research Council.
- NOAA. (2017, 10 2). *NOAA Nautical Chart Catalog and Chart Viewer*. (N. O. Administration, Editor) Retrieved 08 01, 2018, from <http://www.charts.noaa.gov/ChartCatalog/Northeast.html>
- NOAA. (n.d.). *Center for Operational Oceanographic Products and Services*. NOAA. Retrieved 09 01, 2018, from <https://www.co-ops.nos.noaa.gov/>
- PIANC. (2006). *Design of Movable Weirs and Storm Surge Barriers*. Brussels, Belgium: PIANC.
- Rozenzweig, C., Major, D., Demong, K., Stanton, C., Horton, R., & Stults, M. (2007). Ananging climate change risks in New York City's water system: Assesment and adaptation planning. *Mitigation and Adaptation Strategies for Global Change*, 1391-1409.
- Smith, L. (2005). Closing the Doors on Storm Surge. *Coastlines*.
- USACE. (1986). *Project Maps*. New York, NY: USACE.
- USACE. (1989). *Hackensack River Basin, New Jersey - Reconnaissance Report*. New York, NY: USACE.
- USACE. (2002). *Coastal Engineering Manual (CEM)*. Vicksburg, MS: U.E. Army Engineer Research and Development Center.
- USACE. (2002). *Coastal Engineering Manual (CEM)*. Vicksburg, MS: U.E. Army Engineer Research and Development Center.
- USACE. (2016). *Atlantic Coast of New York, East Rockaway Inlet to Rockaway Inlet and Jamaica Bay. Draft Hurricane Sandy General Reevaluation Report and Environmental Impact Statement*. New York, NY: USACE.
- USACE. (2018). *Final Integrated Hurricane Sandy Reevaluation Report and Environmental Impact Statement Atlantic Coast of New York, East Rockaway Inlet to Rockaway Inlet and Jamaica Bay*. New York: USACE.
- USACE. (2019). *New York - New Jersey Harbor and Tributaries Coastal Storm Risk Management Feasibility Study - Interim Report*. New York: USACE.
- USACE ERDC. (2019). *Analysis of Potential Storm Surge Barrier Impacts during Normal Tidal Conditions*. Vicksburg, MS: ERDC.

- USACE ERDC. (2019). *Analysis of Potential Storm Surge Barrier Impacts during Normal Tidal Conditions*. Vicksburg, MS: ERDC.
- USACE ERDC. (2022). *New York – New Jersey Harbor and Tributaries Coastal Storm Risk Management Feasibility Study - Adaptive Hydraulics (AdH) Model Report*. US Army Corps of Engineers, Engineer Research and Development Center.
- USACE. (February 1989). *Hackensack River Basin, New Jersey - Reconnaissance Report*. New York, NY: USACE.
- USACE-WES. (1976). *Effects of Hurricane Surge Barrier on Hydraulic Environment, Jamaica Bay, New York - Hydraulic Model Investigation (Technical Report H-76-14)*. Vicksburg, MS: Hydraulics Laboratory, US Army Engineer Waterways Experiment Station.
- USGS. (2018). <https://streamstats.usgs.gov>. USGS. Retrieved 01 15, 2019, from <https://streamstats.usgs.gov>
- van Ledden, M., Lansen, A., de Ridder, H., & Edge, B. (2012). Reconnaissance level study Mississippi storm surge barrier. In P. L. Smith (Ed.), *Proceedings of 33rd Conference on Coastal Engineering*. Santander, Spain: Coastal Engineering Research Council.

Annexes