



Martin O'Malley, *Governor*  
Anthony G. Brown, *Lt. Governor*

Beverley K. Swaim-Staley, *Secretary*  
Melinda B. Peters, *Administrator*

**Maryland Department of Transportation**

## **STATE HIGHWAY ADMINISTRATION**

### **RESEARCH REPORT**

# **LOW COST STRUCTURAL HEALTH MONITORING OF BRIDGES USING WIRELESS SENSPOT SENSORS**

**MEHDI KALANTARI  
AMIRHOSSEIN MIRBAGHERI**

**UNIVERSITY OF MARYLAND, COLLEGE PARK**

**FINAL REPORT**

**May 2012**

The contents of this report reflect the views of the authors who are responsible for the facts and the accuracy of the data presented herein. The contents do not necessarily reflect the official views or policies of the Maryland State Highway Administration. This report does not constitute a standard, specification, or regulation.

## Technical Report Documentation Page

1. Report No. <b>MD-12-SP109B4M</b>	2. Government Accession No.	3. Recipient's Catalog No.	
4. Title and Subtitle <b>Low Cost Structural Health Monitoring of Bridges Using Wireless SenSpot Sensors</b>		5. Report Date <b>May 2012</b>	
		6. Performing Organization Code	
7. Author/s <b>Mehdi Kalantari Amirhossein Mirbagheri</b>		8. Performing Organization Report No.	
		10. Work Unit No. (TRAIS)	
9. Performing Organization Name and Address <b>University of Maryland College Park, MD 20742</b>		11. Contract or Grant No. <b>SP109B4M</b>	
		13. Type of Report and Period Covered <b>Final Report</b>	
12. Sponsoring Organization Name and Address <b>Maryland State Highway Administration Office of Policy &amp; Research 707 North Calvert Street Baltimore MD 21202</b>		14. Sponsoring Agency Code <b>(7120) STMD - MDOT/SHA</b>	
		15. Supplementary Notes	
16. Abstract: Deterioration of highway bridges is a common, yet complex problem. To protect highway bridges, this project combines a number of recent and emerging technologies – microstructured sensing, ultra-low-power wireless communication, and advanced microelectronics – into a novel, small, and lightweight wireless device known as SenSpot. SenSpot sensors are based on <b>Active RF Technology (ART)</b> , which offers a high performance method for large-scale sensing, wireless synchronization, and ultra low power wireless communication. To evaluate ART technology, the project investigators studied laboratory and field performance of SenSpot sensors. In particular, research was conducted to study performance of SenSpot sensors in accurate measurement of strain and tilt (inclination). Laboratory experiments showed that although SenSpot sensors operate under extremely tight energy constraints and consume less than 4 microwatts of power, the devices provide a very accurate measurement of strain and tilt. Moreover, field performance of SenSpot sensors installed on a bridge on I-495 was closely analyzed. The study showed that SenSpot sensors used to measure tilt on the bridge bearings provide a consistent readout with the expected change in the orientation of the bearings as a result of thermal expansion/contraction of the bridge deck; hence, SenSpot sensors provide a reliable remote monitoring tool to detect instances where bridge bearings could possibly freeze or overturn. Additionally, SenSpot sensors that were used for strain measurement showed that the device can detect instances when loading conditions of a bridge change or a structural change in the bridge happens.			
17. Key Words: <b>wireless, bridge health monitoring, strain, tilt, bearing, SenSpot</b>		18. Distribution Statement: No restrictions <b>This document is available from the Research Division upon request.</b>	
19. Security Classification (of this report) <b>None</b>	20. Security Classification (of this page) <b>None</b>	21. No. Of Pages <b>18</b>	22. Price

**Form DOT F 1700.7 (8-72) Reproduction of form and completed page is authorized.**

## Table of Contents

1. Introduction and problem statement .....	6
2. Proposed Solution: SenSpot sensors.....	6
3. Installation procedure of a SenSpot sensors .....	8
4. Laboratory evaluation of SenSpot sensors .....	9
5. Deployment of SenSpot sensors on highway bridges.....	12
5.1. SenSpot on bridge bearings .....	12
5.2. SenSpot for strain measurement on bridge deck.....	16
6. Conclusion.....	17
7. Acknowledgment.....	18

## List of Figures

Figure 1: A SenSpot (left) and installed sensor on a bridge bearing (right) for tilt and loading monitoring .....	6
Figure 2: Left to right: SenSpots for humidity, tilt, crack, and strain monitoring.....	7
Figure3: Illustration of a complete bridge health monitoring system based on SenSpot sensors.....	8
Figure 4: Installation of one heat cured and 3 cold cured strain gauge to the test specimen...10	
Figure 5: The experimental setup after attaching SenSpot sensor to one of the cold cured strain gauges and connecting the power supply and the $\mu$ volt meter to the heat cured strain gauge.....	10
Figure 6: the test setup for producing positive and negative strain values on the test specimen .....	11
Figure 7: The comparison of the strain readouts of the heat cured system and two SenSpot sensors with cold cured strain gauge attachment.....	11
Figure 8: Wireless tilt sensor on a rocker bearing of Northwest Branch Bridge on I-495 .....	12
Figure 9: Bearings tilt variation during 24-hour period.....	13
Figure 10: The schematic of rocker bearings, per design sheets of the bridge.....	13
Figure 11: (a) schematic of the bridge per design sheets. (b) a magnified view of the section of the bridge on which the SenSpot tilt sensor has been installed.....	14
Figure 12: a 3-week trace of bearing tilt measured by SenSpot versus temperature.....	15
Figure 13: Installed SenSpot strain under the deck of Northwest Branch Bridge on I-495 ....	16
Figure 14: A snapshot of strain readout of SenSpot under deck of Northwest Branch Bridge showing a permanent increase on Oct. 31st 2011 .....	16

**List of Tables**

Table 1: The numerical data of comparison of strain readout of the heat cured system with two SenSpot sensors ..... 8

Table 2: Illustration of steps for installation of a SenSpot strain ..... 12

Table 3: Summary of some of events detected by the strain sensor ..... 17

## 1. Introduction and problem statement

Deterioration of critical infrastructure – such as bridges, pipelines, and railways – is a common, yet complex problem. Currently, a mandated bi-annual inspection is the most common practice used to monitor the structural integrity of bridges. However, manual inspections have proven to be insufficient to ensuring safety. Such inspections do not provide enough information to prevent catastrophic failures. For example, the Minneapolis I-35W Bridge collapse in August 2007, which led to the loss of 13 lives. The magnitude of the bridge safety problem has been highlighted by the Federal Highway Administration, which determined that 71,429 bridges in the United States are rated as structurally deficient – the same rating assigned to the Minneapolis I-35W Bridge before its collapse. The number of deficient bridges is about 12% of the total number of bridges in this country.

Beyond manual inspections, other existing techniques for structural health monitoring suffer from non-scalability due to the high cost of instrumentation devices, large installation costs (e.g., due to wiring needs), or high maintenance costs. To ensure public safety and the continuous serviceability of bridges, it is imperative to develop cost effective, easy to use, and reliable technologies that regularly assess their structural health and integrity.

## 2. Proposed Solution: SenSpot sensors

To protect highway bridges, this project combines a number of recent and emerging technologies – micro-structured sensing, ultra-low-power wireless communication, and advanced microelectronics – into a novel, small, and light-weight wireless device known as SenSpot. SenSpot sensors are based on **Active RF Technology (ART)**, which offers a high performance method for large-scale sensing, wireless synchronization, and ultra low power wireless communication. SenSpots are small with dimensions of 1.3in×3.5in and thickness of 0.55in. Due to their small size and that they are lightweight, these adhesive-mount SenSpot sensors can be easily applied to as many critical spots on structures as needed, with minimal effort.



Figure 1: A SenSpot (left) and installed sensor on a bridge bearing (right) for tilt and loading monitoring.

Figure 1 shows a SenSpot sensor. This device is powered using a built-in prime lithium-ion battery which is designed to supply the energy needed by the device for 30 years. The device uses sensing, synchronization, and ultra-low-power wireless communication technology. A picture of a SenSpot installed on a bridge bearing is also shown in Figure 1. In this installation, the sensor monitors the tilt of the bearing as well as the load on the bearing through strain measurement. In addition, the sensor monitors changes in these parameters as the bridge expands or contracts as a result of temperature variations (please see the case studies in Section 5 for more details).



**Figure 2: Left to right: SenSpots for humidity, tilt, crack, and strain monitoring.**

Currently, SenSpot sensors offer a variety of features that meet the needs for monitoring bridges: strain, tilt, moisture and humidity, temperature, pressure, and crack width. A number of these SenSpot sensors are shown in Figure 2:

- The SenSpot on the left, which monitors relative humidity, has a special probe that is connected to the main body of the sensor through a variable-length cable.
- The second device monitors tilt (inclination) with a resolution of 0.1 degrees.
- The next device is a special SenSpot that measures crack activity (or crack-meter with a resolution of 0.1 mm (0.004 inches). When installed on an existing crack, it will monitor the activity and growth of that crack. The device can also be installed at locations where the development of a crack is a possibility (e.g., at welds, attachment points, etc.).
- The device on the far right offers the combined strain and tilt measurement, with accuracies of 0.1 degree and 2 microstrains for tilt and strain, respectively. A special application of this device is the combined monitoring of loading and tilt on bridge rocker bearings (please see case study 1 in the Appendix).

In addition to the aforementioned capabilities, all of the devices pictured have built-in temperature sensing capability with 0.1°C resolution.

In addition to the SenSpot sensors, a complete bridge health monitoring system based in the proposed approach includes software and hardware components for (1) reliable collection of SenSpot data, (2) aggregation of data, (3) adding timestamps, (4) communicating the data to a remote server, and, finally, (5) visualizing the data and detecting structural issues. Figure 3 shows a picture of a practical structural health monitoring system, which includes the following components:

- ✓ SenSpot sensors attached to structure (average 10-100 per bridge, depending on design and monitoring needs).

- ✓ A data collector (known as SeniMax), which collects data on site of SenSpot and sends it to a remote server (1 per bridge).
- ✓ Software (known as SenScope) that analyzes data and generates alerts.

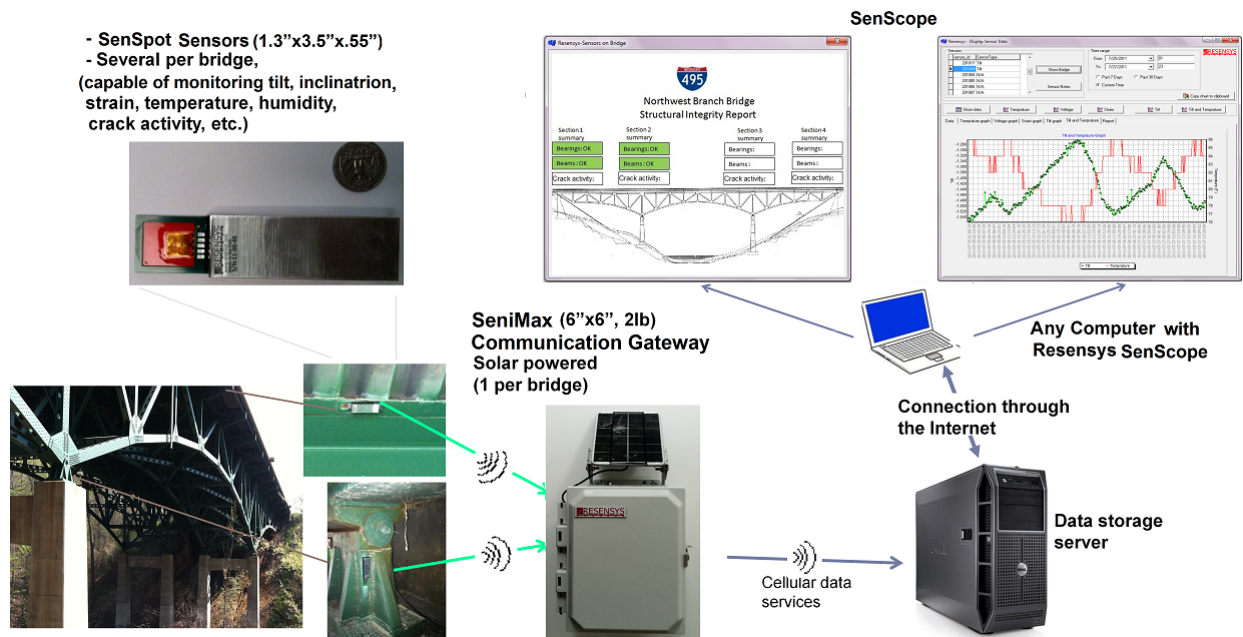





Figure3: Illustration of a complete bridge health monitoring system based on SenSpot sensors



### 3. Installation procedure of a SenSpot sensors

Installation of SenSpot sensors is relatively easy, fast, and straightforward. As an illustrative example, we will review the steps needed to attach a SenSpot strain gauge to a test specimen in Table 2.

Table 1: Illustration of steps for installation of a SenSpot strain

<p><b>Step 1:</b> Clean the metal surface with a tissue to ensure there is no residual dust, moisture, and rusting on the installation spot.</p>	
<p><b>Step 2:</b> Scratch the installation spot using coarse sandpaper (grit 80) to remove the paint or coating to access the bare surface of the metal. This step usually takes 1-2 minutes.</p>	
<p><b>Step 3:</b> Apply one drop of the cold cured adhesive to the scratched spot. Using the provided piece of Teflon tape spread the adhesive on the scratched spot evenly.</p>	



<p><b>Step 4:</b> Remove the backing adhesive completely and adjust the strain gauge on top of the scratched spot so that it is properly aligned. Then put the sensor on the metal and apply a uniform pressure for 10-15 seconds to attach the body of the sensor to the surface.</p>	
<p><b>Step 5:</b> Keep pushing through the open window of SenSpot strain gauge for approximately 2 to 3 minutes to ensure that it is tightly attached.</p>	

Completion of the steps above takes an average of 3-5 minutes.

#### 4. Laboratory evaluation of SenSpot sensors

Although SenSpot sensors provide a wide range of measurement, in this section we will study the accuracy of strain measurement in a laboratory setting (as a sample quantity reflecting the accuracy of the sensors).

An important issue that may cause the strain readout of the SenSpot sensors to be different from conventional strain sensors is the attachment procedure. For maximum accuracy, the traditional strain gauges use heat cured adhesives to attach the resistive strain gauge to a test specimen. In this procedure, a special thermal treatment procedure is applied to the test specimen after attaching the strain gauge. The heat applied to the specimen usually exceeds 200-300 °F (100-200 °C) for known intervals of time. A challenge of using SenSpot sensors for strain measurement is that these devices are attached to a structure (e.g., a bridge) at the site using cold cured adhesives. Using heat cured adhesives is not an option given the nature and application domain of SenSpot sensors, which are meant to be retrofit to the existing structures, where applying a complicated thermal treatment for curing is not feasible.

The findings in this report shows that the attachment procedure using cold cured attachment procedure used for SenSpot sensors provides a comparable bonding quality as the heat cured adhesives for strain measurement with accuracy of 3 $\mu$ strain (or about 3% assuming a full scale of 100  $\mu$ strains). The test conducted is explained the next few paragraphs.

**A. Reference installation:** The purpose of the reference installation is to find an accurate readout of strain so the readout of SenSpot sensors can be compared to it.

In this installation, a 350 $\Omega$  full bridge strain gauge was attached to a test specimen. The part number for the strain gauge used is SGT-3G/350-FB11 by Omega Engineering, and its gauge factor was 2.18. A TT300 heat cured adhesive by Omega Engineering was used for attachment. The thermal treatment was followed as advised by the vendor (instructions available at <http://www.omega.com/Manuals/manualpdf/M2037.pdf>). For a reliable attachment, a constant pressure of 20 to 30 psi was applied uniformly to the strain gauge during the curing process. To do this, a spring clamp together with a silicon rubber and a thin film of Teflon tape are used (per vendor's instructions). After attachment, a stable power supply (E3630A by HP) was used to provide a 3.0V excitation voltage to the strain gauge. The output of the strain gauge was read using a Fluke 8088A, 5.5 digit  $\mu$ voltmeter. This instrument can read voltage with a resolution of 1  $\mu$ V. In this setup, each  $\mu$ strain applied to the test specimen results in a change of  $2.18 \times 3.0V = 6.54\mu V$  in the readout of the Fluke  $\mu$ volt meter. In other words, the resolution of strain measurement is approximately  $1/6.54 = 0.15 \mu$ Strain. The attached strain gauge and the test setup are shown in Figures 4 and 5.

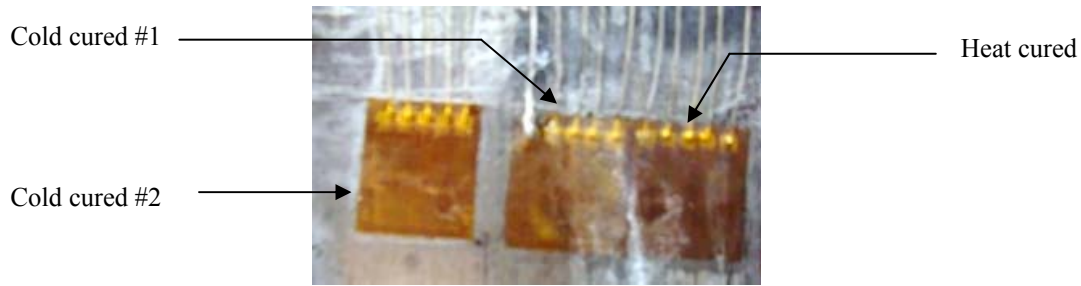

**Figure 4: Installation of one heat cured and 3 cold cured strain gauge to the test specimen.**

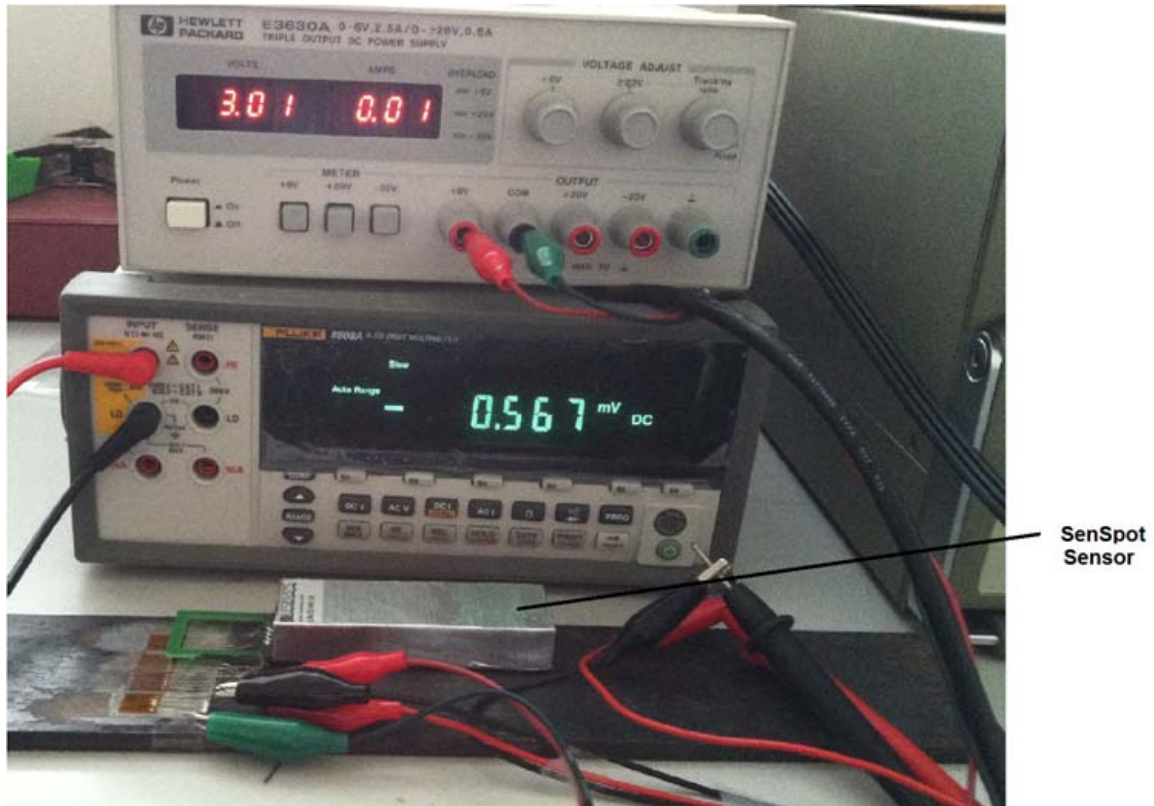

**Figure 5: The experimental setup after attaching SenSpot sensor to one of the cold cured strain gauges and connecting the power supply and the  $\mu$ volt meter to the heat cured strain gauge.**

**B. SenSpot sensor:** Parallel to the reference installation, 2 strain gauges were attached to the test specimen using SG496 rapid cured adhesive provided by Omega Engineering, as shown in Figure 5. This adhesive is the one used to quickly attach SenSpot sensors to structures on site.

**C. Test results:** The test specimen was put on a table and a vertical force was applied to it by incrementally adding 5Kg and 3.8Kg weights on it as shown in Figure 6. As shown in the figure, two different setups were used to produce positive and negative strain values. Upon placing each weight, the readout of the SenSpot sensor and the  $\mu$ volt meter were recorded. Using different reference weights, various strains from approximately  $-124 \mu\text{Strain}$  to  $107 \mu\text{Strain}$  were produced on the test specimen.

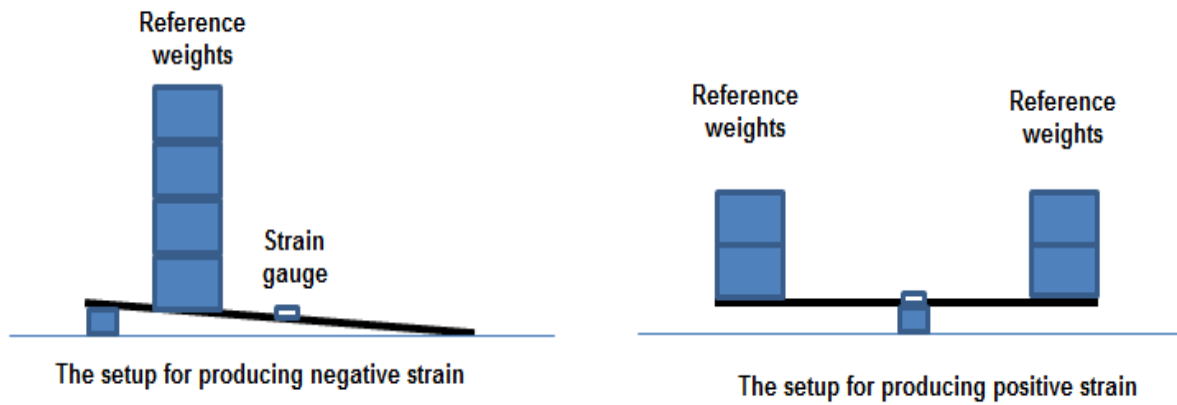

**Figure 6: the test setup for producing positive and negative strain values on the test specimen.**

The plot in Figure 7 shows the comparison of the heat cured system with the two SenSpot sensors. Also, the numerical data is shown in table 1. As can be seen in the plot of Figure 7, the readout of the two SenSpot sensors with cold cured adhesives are very close to the readout of the heat cured system. Indeed, as noted in Table 1, the maximum strain error (defined as the maximum deviation of the SenSpot sensor readouts from the heat cured system) was measured to be  $-3.21 \mu\text{Strain}$  over the complete range of the strain values applied. The strain measurement using commercially available devices such as SG-LINK by Microstrain is  $1 \mu\text{Strain}$ , which shows an error of  $3.21 \mu\text{Strain}$  is within the reasonable range of error.

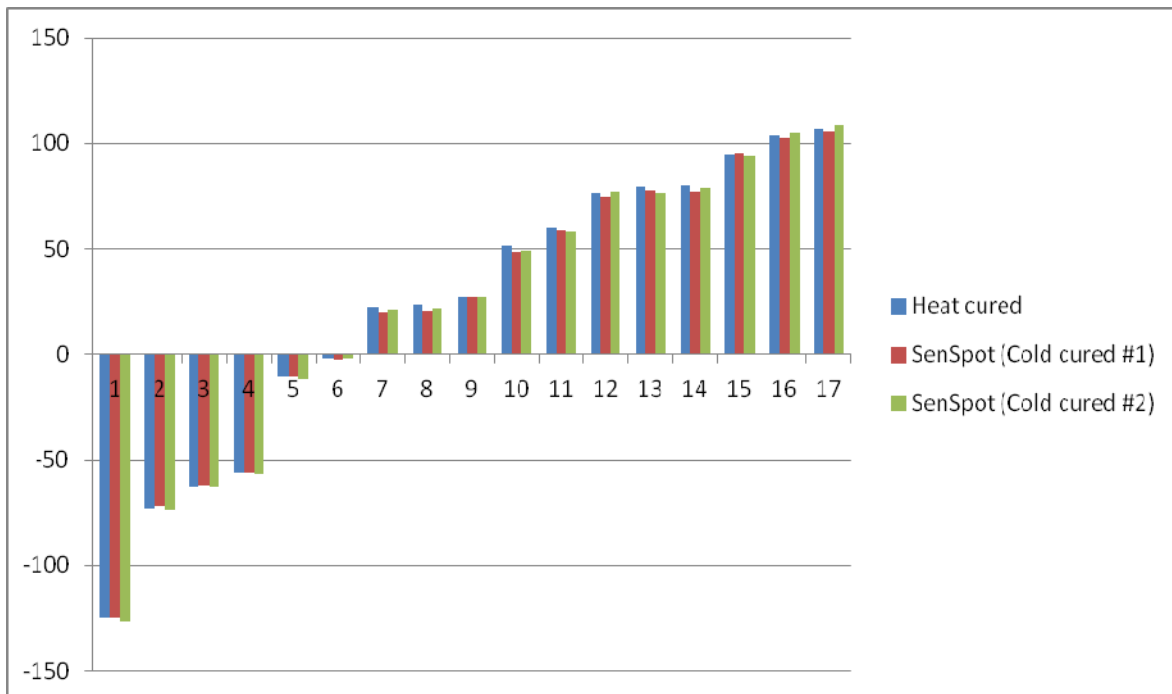

**Figure 7: The comparison of the strain readouts of the heat cured system and two SenSpot sensors with cold cured strain gauge attachment.**

**Table 2: The numerical data of comparison of strain readout of the heat cured system with two SenSpot sensors.**

Heat cured readout ( $\mu$ Strain)	SenSpot sensor readout, cold cured #1 ( $\mu$ Strain)	SenSpot sensor readout, cold cured #2 ( $\mu$ Strain)	Error SenSpot, cold cured #1 ( $\mu$ Strain)	Error SenSpot, cold cured #2 ( $\mu$ Strain)
-124.62	-124.92	-126.91	-0.31	-2.29
-73.24	-72.02	-73.85	1.22	-0.61
-62.69	-62.08	-63.00	0.61	-0.31
-56.27	-55.81	-56.88	0.46	-0.61
-10.24	-10.70	-11.62	-0.46	-1.38
-1.83	-2.45	-1.66	-0.61	0.18
22.32	20.18	21.10	-2.14	-1.22
23.55	20.34	21.71	-3.21	-1.83
27.37	27.22	27.06	-0.15	-0.31
51.38	48.47	48.93	-2.91	-2.45
59.94	58.56	58.10	-1.38	-1.83
76.45	74.46	76.91	-1.99	0.46
79.82	77.52	76.45	-2.29	-3.36
80.12	77.22	78.90	-2.91	-1.22
94.95	95.41	94.19	0.46	-0.76
104.13	102.75	105.35	-1.38	1.22
107.19	105.96	108.56	-1.22	1.38

## 5. Deployment of SenSpot sensors on highway bridges

As two illustrative examples of using SenSpot sensors, the research team studied two deployment cases of SenSpot tilt and strain on Northwest Branch Bridge on I-495 in Montgomery County, Maryland.

### 5.1. SenSpot on bridge bearings

SenSpot tilt sensors can gather changes in the tilt of the bearing by angles as small as 12 arc seconds (or approximately 0.003 degrees). Tilt changes happen as a result of daily temperature variations. Such changes can be monitored by the installed tilt sensors. The installed tilt sensor on a rocker bearing is shown in Figure 8.



**Figure 8: Wireless tilt sensor on a rocker bearing of Northwest Branch Bridge on I-495**

The tilt data gathered by the sensor is wirelessly transmitted to a wireless data collector (SeniMax) at the bridge, which in turn transmits data wirelessly to a remote server for processing, visualization, and archiving. Installation is straightforward, and for best performance, it is recommended to install the sensors on the side of bearing as shown in Figure 8. Figure 9 shows a bearing's tilt readout provided by the installed SenSpot during 24-hour period from July 28th 2011 until July 29th 2011. As shown in the figure, the SenSpot reported tilt measurements ranging from 1.70 to 2.45 degrees. In other words, the change in tilt of the bearing was  $2.45 - 1.70 = 0.75$  degrees. In this case, the theoretical tilt change can be calculated by considering the temperature variation of the mentioned day. During this 24-hour period, the minimum temperature was 69 °F and the maximum was 89°F (source: <http://www.wunderground.com/history/>). Therefore, the variation of the temperature that day was 20 °F.

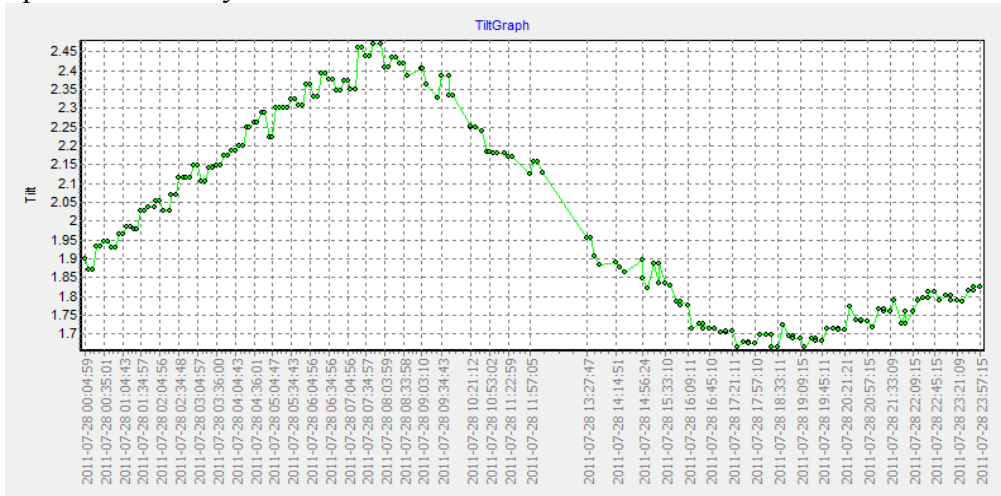

Figure 9: Bearings tilt variation during 24-hour period

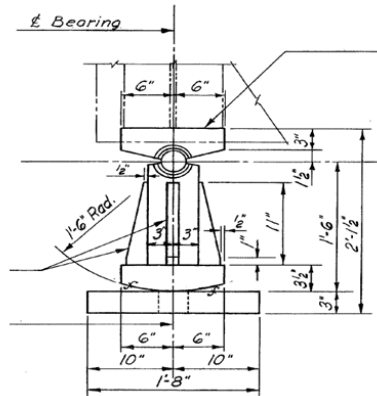

Figure 10: The schematic of rocker bearings, per design sheets of the bridge.

Figure 10 shows the drawing of the rocker bearings on the bridge (from bridge design sheets). To calculate the dependence of the tilt of the bearing on the temperature, we use the following data:

- R:** the radius of the bearing =  $1' 6'' = 18'' = 0.4572$  meters (shown in Figure 10)
- D:** the expandable portion of bridge deck =  $150'' = 45.75$  meters (shown in Figure 11)
- $\lambda$ :** Thermal expansion coefficient of the bridge:  $12 \times 10^{-6}$

Therefore, per degree Celsius change of temperature, the change in the expandable portion of the bridge is:

$$\Delta L = \lambda \times D = 12 \times 10^{-6} \times 45.75 = 0.00055 \text{ meters} = 0.55 \text{ mm}$$

As a result, the change in the tilt per degree Celsius is:

$$\Delta \theta = \text{tg}^{-1} (\Delta L / R) = \text{tg}^{-1} (0.55 \text{ mm} / 0.4572 \text{ meters}) = 0.0012 \text{ radian} = 0.068 \text{ degrees} = 248 \text{ arc seconds}$$

In other words, the theoretical change in tilt of the rocker bearing per degree Celsius is 0.068 degrees, which is equivalent to 248 seconds. Equivalently, the amount of change in the tilt of the bearing per degree Fahrenheit can be calculated by dividing the above numbers by 1.8. Therefore, the theoretical change is 0.038 degrees or 139 seconds per degree Fahrenheit. As a result, the theoretical tilt change is calculated to be 139 seconds change per degree Fahrenheit. Therefore, the theoretical change in tilt is calculated as:  $139 \times 20 = 2780$  seconds.

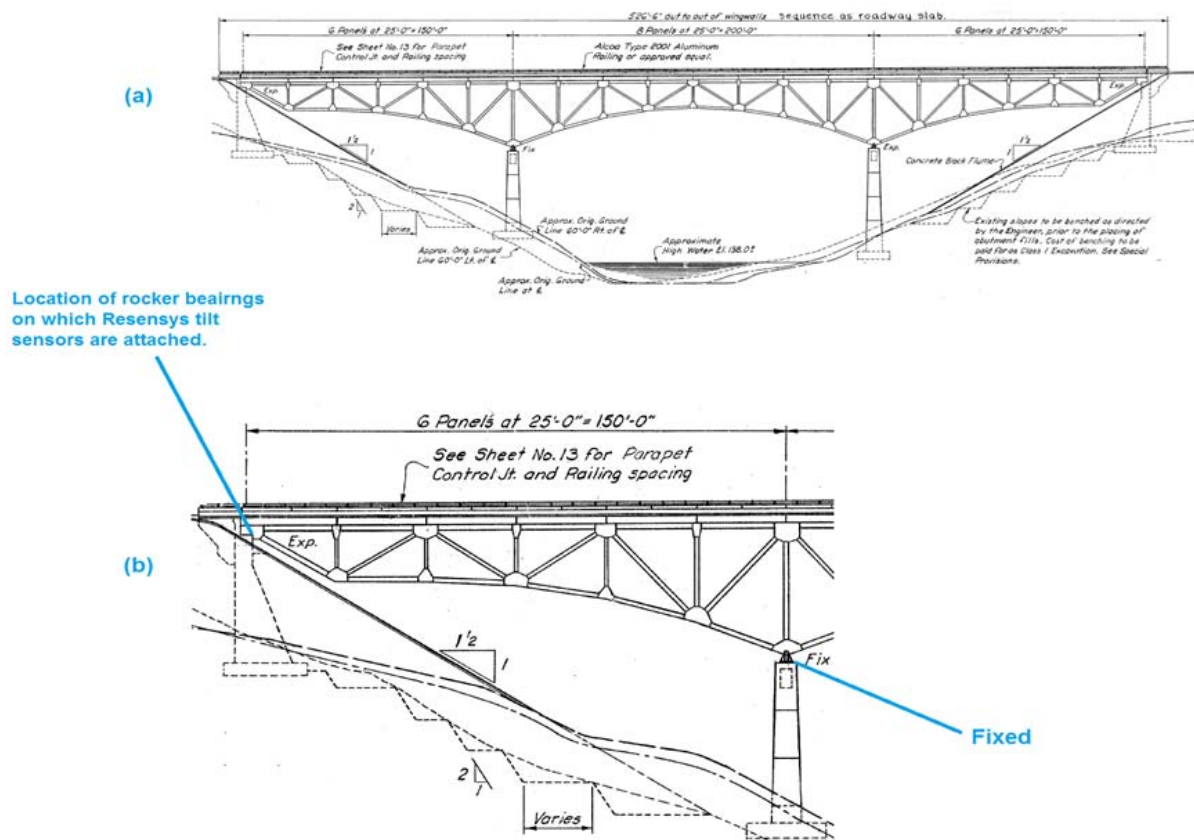

**Figure 11: (a) schematic of the bridge per design sheets. (b) a magnified view of the section of the bridge on which the SenSpot tilt sensor has been installed.**

To summarize, the theoretical and measured tilt variations can be compared as:

The measured tilt variation: **2734 seconds = 0.7594 degrees**

The theoretical tilt variation: **2780 seconds = 0.7722 degrees**

$$\text{Error: } 46/2780 = 1.6\%$$

As a final remark, it should be noted that SenSpot has an internal temperature sensor, which could be used for this analysis; however, since the internal temperature sensor of SenSpot reports



temperature on the bearing, which could be different from temperature of the deck because the bearing is in a shaded area, it cannot be used for an accurate analysis. Note that the actual change in tilt of bearing is a function of change in temperature of the bridge deck. Therefore, we used temperature from the local weather station for the sake of analysis. In a similar analysis in the next paragraph we will use the 3-week temperature measurement from a different SenSpot that was attached underneath the bridge deck in order to calculate the theoretical change in tilt of bearings. The results show that regardless the temperature information source, SenSpot sensors give a consistent measurement of the tilt of bearings.

**Bearing change versus Temperature:** as an interesting observation, the graph in Figure 12 shows the tilt of bearing versus temperature reported by the SenSpot sensor on the bearing during a 3-week period (from March 20 2012 until April 9, 2012). The green graph in the figure shows tilt while the purple graph shows the deck's temperature measured by a different SenSpot. As shown in the picture, the change in temperature of deck affects the tilt of the bearing. An increase in the deck's temperature results in a decrease in tilt, and conversely decreasing temperature of the deck increases the tilt. The shown behavior indicates a healthy behavior of the bearing. As an interesting observation, the temperature of the deck during this time period was reported to be around  $78-25=53^{\circ}\text{F}$ ; therefore, the expected change in the bearings tilt should be  $53^{\circ}\text{F} \times 139 \text{ sec}/^{\circ}\text{F}=7367 \text{ seconds}=2.05 \text{ degrees}$ . This expected change is consistent with the readout of the SenSpot, which reported approximately 2.1 degrees of change in the bearing tilt (from -1.0 degree to +1.1 degree) as can be seen in Figure 12.

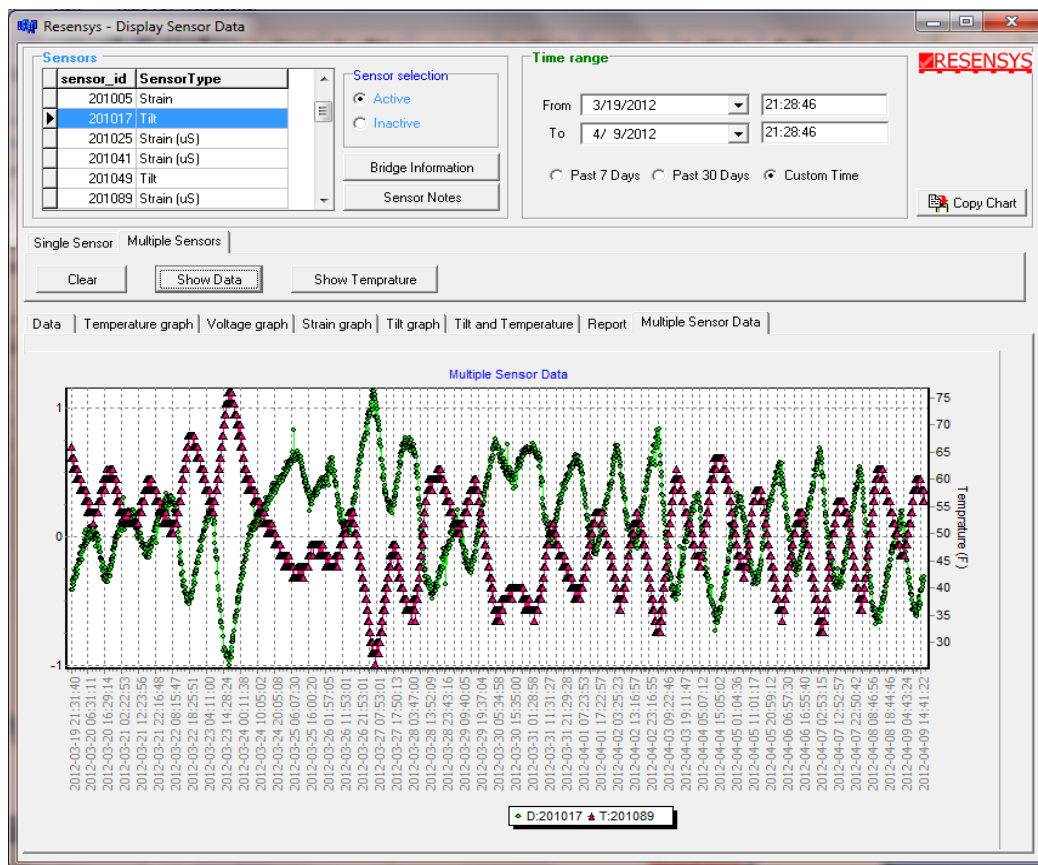

Figure 12: a 3-week trace of bearing tilt measured by SenSpot versus temperature.

## 5.2. SenSpot for strain measurement on bridge deck

To evaluate the performance of SenSpot for monitoring strain, a sensor was installed on the deck of Northwest Branch Overpass on I-495. The installed SenSpot is shown in Figure 13.



Figure 13: Installed SenSpot strain under the deck of Northwest Branch Bridge on I-495.

As a particular example of detection by the system, the following graph shows permanent increase (shift) in strain readout of a sensor by approximately 7 microstrains at about 20:19 on Monday Oct 31<sup>st</sup>. In this case, it was confirmed that the increase was due to insertion of a new portion of the concrete deck during the mentioned hours.

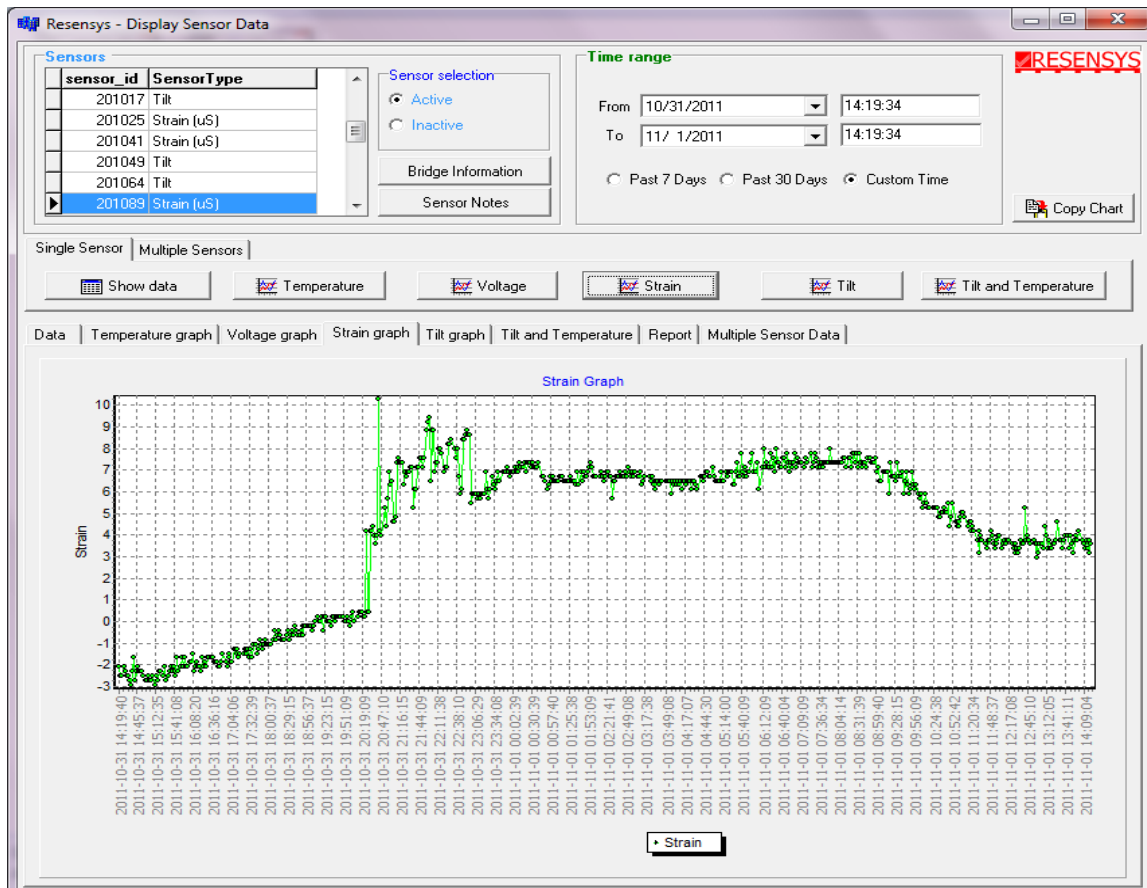

Figure 14: A snapshot of strain readout of SenSpot under deck of Northwest Branch Bridge showing a permanent increase on Oct. 31st 2011.



Similarly, there were numerous instances where the sensor detected anomalies in strain readout, and all of the mentioned anomalies were confirmed with ground truth data. Examples of such detections are shown in the Table 3. It must be noted that all of the detected changes were due to the fact that during the monitoring period the bridge was under rehabilitation, but detection of these issues indicates that the proposed system is capable to detect changes in the structure regardless of the cause.

**Table 3: Summary of some of events detected by the strain sensor**

Date	Event	Confirmed cause
Oct. 31 <sup>st</sup> 2011	Steady increase in strain	Placing a new portion of concrete deck in median area
Nov. 123 <sup>rd</sup> 2011	Temporary strain increase	Bridge rehabilitation machinery
Dec 2 <sup>nd</sup> 2011	Temporary strain increase	Bridge rehabilitation machinery
Dec 12 <sup>th</sup> -Dec18 <sup>th</sup> 2011	Steady increase in strain readout	Placing a new portion of concrete median
Dec 21 <sup>st</sup> 2011	Steady decrease in strain	Removing concrete traffic barriers that separate work zone from bridge traffic in median area.
Jan 3 <sup>rd</sup> 2012	Steady increase in strain	Placing concrete traffic barriers that separate work zone from bridge traffic in right most lane
Jan 24 <sup>th</sup> 2012	Temporary increase in strain	Bridge rehabilitation machinery

## 6. Conclusion

SenSpot sensors provide a low cost, easy to install, scalable solution for distributed structural health monitoring on highway bridges. The work presented in this report was focused on the laboratory and field performance of SenSpot sensors. In particular, SenSpot sensors were studied in two scenarios. In the first scenario, sensors were used to monitor correct operation of bridge bearings. Small sub-degree change in tilt of bearings as a result of temperature change was measured using SenSpot sensors attached to the bearings. The readout was compared with the expected theoretical values. The comparison showed consistency of the measurements with the theoretical values. In a different set of experiments, performance of SenSpot strain gauges was studied in a laboratory setting. The study showed that when used for strain measurement, SenSpot sensors can detect instances when loading conditions of a bridge change or a structural change in the bridge happens.

As a final conclusion, a number of unique features distinguish SenSpot sensors from existing solutions for bridge health monitoring. These features include:

**Very easy and fast installation:** SenSpot sensors are very lightweight (20-25 g), small in size (1.3in×3.5in×1.3in), and self adhesive. Attachment of SenSpots does not require drilling or a complicated mounting procedure. The average installation time is 1-2 minutes per SenSpot.

**Long lifetime (multiple decades):** ultra-low-power sensing and wireless communication technology enables SenSpots to operate for decades. Although the minimum expected lifetime is 20 years, the typical lifetime is 30 years.

**Feature-rich devices:** SenSpot sensors offer a wide range of sensing features, including strain, tilt, pressure, temperature, crack activity, moisture, humidity, etc.

**Maintenance-free operation:** SenSpot sensors can operate completely maintenance-free for decades. After installation, the devices do not need any calibration, battery replacement, or other maintenance during their entire service life.

**Monitoring with minimal attendance:** Using SenScope monitoring software, the proposed system can be configured to produce alerts only if abnormal behavior is detected in structural quantities (e.g., a normal pattern of tilt variation in bearings is not observed or structural

quantities exceed preset thresholds). Upon detecting such issues, SenScope can inform the bridge operators through different modes of communications. Currently, work is in progress to provide such alerts through email notifications.

The combination of the above features provide a practical, low cost, yet powerful solution for the challenging problem of remote bridge health monitoring. While the small quantity production cost of SenSpot sensors is about \$150-\$200 per device, similar to other electronic devices, it is projected that the cost will be significantly reduced when produced in large quantities. If manufactured in volume of 10000 or more for example, the cost of the SenSpot sensors is projected to drop below \$50.

Due to self adhesive design of SenSpots (which contributes to their easy installation), the current SenSpots are not intended to be reused; however, reusable versions can be provided with minor modification in the design, so they will be mounted using small screws. Additionally, from cost effectiveness viewpoint of the proposed system, certain elements such as the SenScope monitoring software impose a one-time licensing expense; however, the design of SenScope is such that a single license will work for a countless number of bridges that are intended to be monitored.

As a final note, the proposed system is dependent on cellular data communication services to transmit data from a bridge site to an office. SeniMax uses cellular data coverage to transmit data of sensors to an office. This may pose a weakness in areas with poor cellular coverage. While most current roads and highways have reasonable cellular coverage, work is in progress to develop versions of SeniMax that use satellite based services as the mode of communications for areas with poor cellular coverage.

## **7. Acknowledgment**

The project investigators express their gratitude to the Maryland State Highway Administration (SHA) for providing research funding and a bridge to evaluate SenSpot sensors in the field. Additionally, the investigators would like to thank Ms. Allison Hardt and Dr. Richard Woo for research meetings, providing feedback, and traveling to the bridge site where SenSpot sensors are installed. Furthermore, the project investigators were fortunate to receive continuous expert advice and valuable feedback from Mr. Jeff Robert and Mr. Rodney Thornton, SHA's Office of Structures.